

4200 Series Cab Tractor Operator Instruction Book

Tractor Models Applicable:

For cab tractor models:

4225, 4235, 4245, 4255, 4260, 4270.

Serial numbers applicable:

K 27456 onwards.

Manufactured from 2001 onwards.

Contents - Page

General Information - 3

Tractor identification.

Introduction.

Warranty, pre-delivery and installation on the farm.

Safety notes.

Safety decals.

Controls and Instruments - 21

Controls.

Instruments.

Operation - 45

Starting.

Running-in.

Operating the tractor.

Maintenance and Adjustment - 99

Maintenance chart.

Recommended lubricants.

Servicing the tractor:

Greasing, checking levels and changing oil.

Adjustments - axles, brakes and wheels.

Replacements - fuses, bulbs and battery.

Fuel storage.

Accessories - 167

Specification - 173

Alphabetical Index - 191

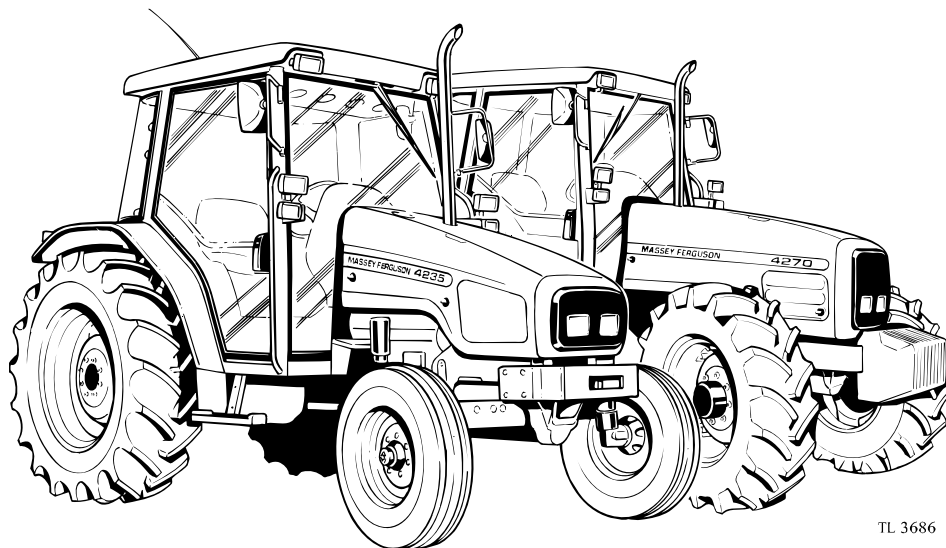

TL 3686

Published by:

AGCO Limited,

Banner Lane,

Coventry,

England CV4 9GF

August 2002

1857 230 M2

Issue 2

© AGCO Limited 2001

Tractor Identification

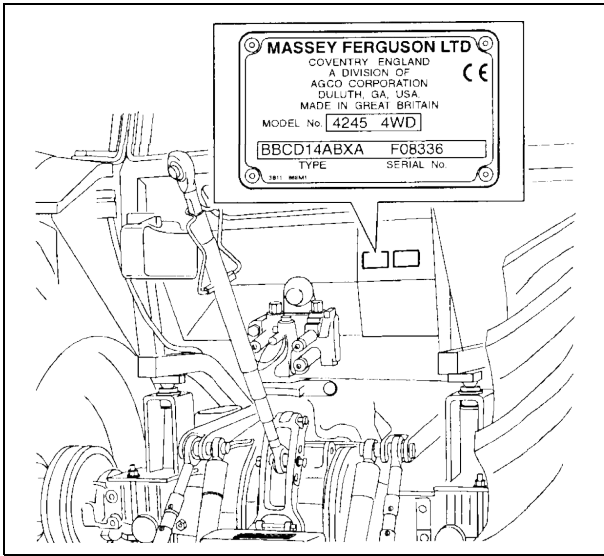

Fig. 1

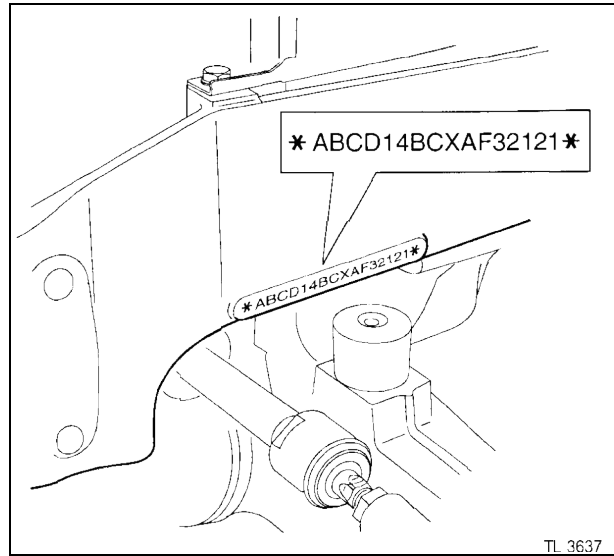

Fig. 2

Serial Numbers

NOTE: Observe the serial numbers of your tractor. Always quote the serial numbers in any communication to your Massey Ferguson Dealer.

Tractor Model:

Tractor Serial No. (Fig. 1 and Fig. 2):
.....

Engine Serial No. (Fig. 3):

Four-wheel Drive Front Axle Serial No. (Fig. 4):
.....

Axle Type:

Nearest Massey Ferguson Dealer:
.....
.....
.....

Phone:

Date of Installation on the Farm:

Expiration of Warranty:

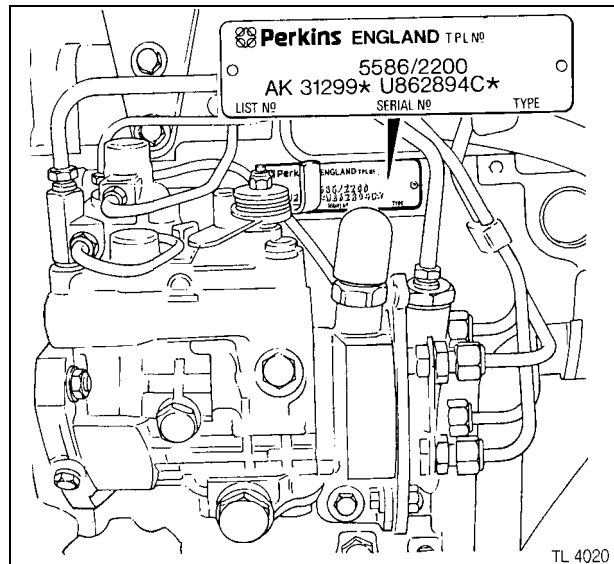

Fig. 3

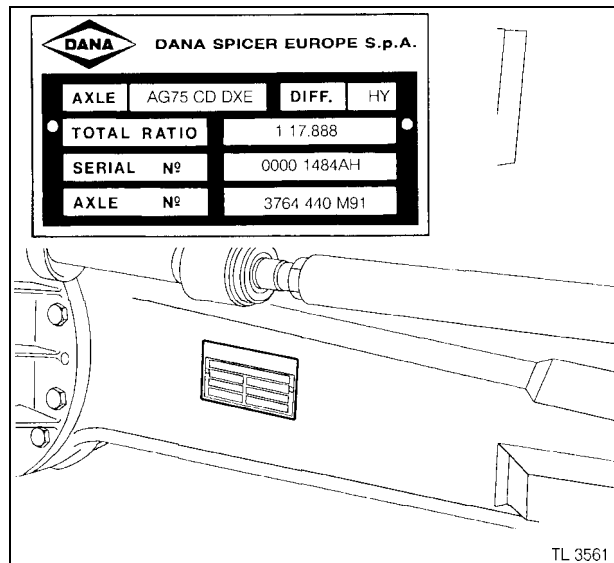

Fig. 4

This publication is written in accordance with International Standard ISO 3600 "Guide to: Information, Content, and Presentation of Operators Manuals Provided for Tractors and Machinery for Agriculture and Forestry".

Introduction, Warranty and Safety Notes

Contents

Introduction	4
Pre-delivery, Installation on the Farm and Warranty	4
Safety	5
EU Declaration of Conformity	5
Tractor and Machine Noise	5
Introduction to Safety	6
A Word to the Operator	6
Follow a Safety Programme	7
Protective Structures	8
Prepare for Safe Operation	9
Servicing the Tractor	11
Starting	12
Work Safely	13
After Operation	18

Introduction and Warranty

Introduction

NOTE: This book is published for worldwide distribution, and the availability of equipment shown either as basic or accessory may vary according to the territory in which the tractor is to be operated. Full details of equipment available in your area can be obtained from your Massey Ferguson Dealer. *Use only Massey Ferguson approved attachments and equipment.*

The purpose of this book is to enable the owner and driver to operate the tractor in a safe manner. Providing that the instructions are followed carefully, the tractor will give years of service in the tradition of Massey Ferguson.

The installation of the product on the farm by the Dealer gives the opportunity to ensure that these operating and maintenance instructions are understood. Always consult your Dealer if you do not understand any part of this book. It is important that these instructions are understood and observed. Daily maintenance should become a routine, and a record of hours in service should be kept.

When new parts are required it is important that only genuine Massey Ferguson service parts are used. Massey Ferguson Dealers supply genuine parts and can give advice regarding their fitment and use. Extensive damage may occur as a result of the fitment of parts of inferior quality. Customers are advised to buy their service parts only from an authorized Massey Ferguson Dealer.

Owing to wide variations in operating conditions, it is impossible for the Company to make comprehensive or definitive statements in its publications regarding performance or methods of use of its machines, or to accept liability for any loss or damage which may result from these statements, or from any errors or omissions. If the tractor is to be used for abnormal conditions which may be detrimental, (e.g. deep water or paddy fields) consult your Massey Ferguson Dealer for special instructions, or the warranty may be invalidated.

These tractors are designed solely for use in customary agricultural operations (intended use).

Use in any other way is considered as contrary to the intended use. Massey Ferguson accepts no liability for any damage or injury resulting from misuse and these risks must be borne solely by the user.

Compliance with, and strict adherence to, the conditions of operation, service and repair as specified by Massey Ferguson also constitute essential elements for the intended use.

These tractors should be operated, serviced and repaired only by persons familiar with all their particular characteristics and who are acquainted with the relevant safety rules (accident prevention).

Customers are strongly advised to use an official Massey Ferguson Dealer in connection with any service problems and adjustments that may occur.

Pre-delivery, Installation on the Farm and Warranty

The Company, when selling new goods to their Dealers, gives a warranty which, subject to certain conditions, guarantees that the goods are free from defects in material and workmanship. Since this book is published for worldwide circulation, it is impossible to detail the exact terms and conditions of warranty that apply to a retail customer in any particular country. Purchasers of new Massey Ferguson equipment should request full details from their supplying Dealer.

In accordance with the Company's policy of continuous improvement to its machines, alterations in the specifications of machines may be made at any time without notice. The Company accepts no responsibility for discrepancies which may occur between the specifications of its machines and the descriptions thereof contained in its publications.

Pre-delivery and Installation on the Farm

A Dealer is required to carry out certain activities when supplying a new Massey Ferguson tractor. These consist of a full pre-delivery inspection to ensure that the tractor supplied is ready for immediate use, and to give full instruction in the basic principles of operation and maintenance of the tractor. These instructions will cover instruments and controls, routine maintenance and safety precautions. All persons who will be concerned with the operation and maintenance of the machine should be present during this instruction period.

NOTE: Massey Ferguson will not accept responsibility for any claim resulting from the fitment of non-approved parts or attachments, or unauthorized modification or alteration.

Warranty Procedure

Correct installation on the farm, coupled with regular maintenance, will do much to prevent breakdowns. If, however, operating trouble is experienced during the warranty period, the following procedure must be adopted:-

- Immediately notify the Dealer from whom you purchased the tractor, quoting the Model and Serial Number. It is most important that there should be no delay, and you should realise that, even where the original failure is covered by warranty, if the failure is not repaired immediately, warranty cover may not apply.
- Provide your Dealer with as much background information as you can. It will help him to know how many hours service has been achieved, the type of work on which you are engaged and the symptoms of the trouble.

It should be noted that normal maintenance services such as tuning, brake/clutch adjustments, and the supply of materials used to service the tractor (oil, filters, fuel and antifreeze) are not covered by the terms of warranty.

Parts Warning

The fitment of non Massey Ferguson parts may result in a part of substandard quality being used. Massey Ferguson will not take the responsibility for any loss, damage or liability resulting from the fitment of such parts, and, if fitted during the normal warranty period the manufacturer's guarantee may be invalidated.

Moving to a new Location

Only the Massey Ferguson Dealer from whom you purchased the tractor is responsible for the protection afforded by your warranty and, where possible, you should always take your tractor to him for repair. If, however, you move to another area or if your tractor should be working temporarily at some distance from the Dealer from whom it was purchased, you are recommended to obtain from that Dealer the name and address of the Massey Ferguson Dealer nearest to your new location and to ask for arrangements to be made for outstanding service warranty commitments to be transferred to the latter. If you have left the area in which the original Dealer operates and have not made arrangements with a new Dealer, the latter will readily provide assistance in an emergency but you will be charged at normal rates for any work undertaken unless:

- You make it clear that the warranty has not expired, and
- You give the repairing Dealer the opportunity to make suitable arrangements with the retailing Dealer.

Service After Warranty

During the warranty period, you should have all your repairs and maintenance performed by your Massey Ferguson Dealer. This ensures that a detailed check is kept on the progress and performance of your new tractor.

In order to obtain the best results from your Massey Ferguson tractor, it is important that regular maintenance and service checks continue after the warranty period has expired. Make use of your local Massey Ferguson Dealer for all major tractor services; a trained mechanic will spot any problems between one service and the next.

The mechanics are regularly trained and updated on the product, servicing techniques and the use of modern service tools and diagnostic equipment. They receive regular Service Bulletins, have all Workshop Manuals and other such technical information to ensure that the repair or service is to the standard required by Massey Ferguson.

Safety

The safety of the operator is one of the main concerns in designing and developing a new tractor. Designers incorporate as many safety features as is possible in constructing our tractors. However, every year many accidents occur which could have been avoided by a few seconds thought and a more careful approach to handling farm machinery and implements.

Read and practice the safety instructions detailed in the next section of this book.



WARNING: In some of the illustrations used in this Operator Instruction Book, panels or guards may have been removed for clarity. Never operate the tractor without these components in position. If the removal of panels or guards is necessary to make a repair, they **MUST** be replaced before operation.

EU Declaration of Conformity

Massey Ferguson tractors conform with the protection requirements relating to Electromagnetic Compatibility.

Tractor and Machine Noise

The Massey Ferguson range of 4200 series tractors meet the sound level requirements in accordance with Directive 77/311 ECC Annex 1, with cab doors and windows closed.

Safety Notes

Safety Alert Symbol and Terms

This safety alert symbol means ATTENTION! BECOME ALERT! YOUR SAFETY IS INVOLVED!



The safety alert symbol identifies important safety messages on machines, safety signs, in manuals, or elsewhere. When you see this symbol, be alert to the possibility of personal injury or death. Follow the instructions in the safety message.

Why is SAFETY important to you?

- ★ ACCIDENTS DISABLE and KILL ★
- ★ ACCIDENTS are COSTLY ★
- ★ ACCIDENTS can be AVOIDED ★

Tractor and Implement Safety

The tractor is a source of power - Mechanical and Hydraulic.

On its own, the tractor is of little practical value. Only when used in conjunction with an implement or other attachment does it become a working unit.

This instruction book is compiled to cover those safe working practices that are associated with the base tractor operation.

It does not cover all operation and safety instructions relevant to all known implements and attachments that may be fitted at the time of tractor delivery or at some future date.

It is essential that operators use and understand the relevant instruction manual of such implements and attachments.

Introduction to Safety

This safety section of your Operator Instruction Book is intended to point out some of the basic safety situations which may be encountered during the normal operation and maintenance of your FOOTSTEP (ROPS) or CAB tractor, and to suggest possible ways of dealing with these situations. This section is NOT a replacement for other safety practices featured in other sections of this book.

Additional precautions may be necessary, depending on attachments used and conditions at the work site or in the service area. Massey Ferguson has no direct control over tractor application, operation, inspection, lubrication, or maintenance. Therefore it is YOUR responsibility to use good safety practices in these areas.

A Word to the Operator

It is YOUR responsibility to read and understand the safety section in this book before operating your tractor. You must follow these safety instructions that take you step by step through your working day.

In reading this section, you will note that illustrations have been used to highlight certain situations. Each illustration is numbered and the same number appears in the text in parenthesis. This number is placed at the end of the written text that refers to the illustration.

Remember that YOU are the key to safety. Good safety practices not only protect you, but also the people around you. Study the features in this manual and make them a working part of your safety programme. Keep in mind that this safety section is written only for this type of machine. Practice all other usual and customary safe working precautions, and above all - REMEMBER - SAFETY IS YOUR RESPONSIBILITY. YOU CAN PREVENT SERIOUS INJURY OR DEATH.

Use only AGCO - Massey Ferguson approved attachments and equipment.

Danger, Warning and Caution

Whenever you see the words and symbols shown below, used in this book and on decals, you **MUST** take note of their instructions as they relate to personal safety.



DANGER: This symbol together with the word **DANGER** indicates an imminently hazardous situation that, if not avoided, will result in **DEATH OR VERY SERIOUS INJURY**.



WARNING: This symbol together with the word **WARNING** indicates a potentially hazardous situation that if not avoided could result in **DEATH** or **SERIOUS INJURY**.



CAUTION: *This symbol together with the word **CAUTION** is used to indicate a potentially hazardous situation that, if not avoided, may result in **MINOR INJURY**.*

IMPORTANT: The word **IMPORTANT** is used to identify special instructions or procedures which, if not strictly observed, could result in damage to, or destruction of the machine, process or its surroundings.

NOTE: The word **NOTE** is used to indicate points of particular interest for more efficient and convenient repair or operation.

Decals



WARNING: **DO NOT** remove or obscure Danger, Warning, Caution or Instruction Decals. Replace any Danger, Warning, Caution or Instruction Decals that are not readable or are missing. Replacement decals are available from your Dealer in the event of loss or damage. The actual location of these Safety Decals is illustrated at the end of this section.

If a used tractor has been purchased, refer to the illustrations at the end of this section to ensure that all the safety warning decals are in the correct position and are readable.

Follow a Safety Programme

For Safe Operation

For safe operation of an agricultural tractor, you must be a qualified and authorized operator. To be qualified you must understand the written instructions supplied in this Operator Instruction Book, have training, and know the safety rules and regulations for the job.

Some regulations specify that no one under the age of 16 years, for example, may operate power machinery. This includes tractors. It is your responsibility to know what these regulations are, and obey them, in the operating area or situation.

These will include, but are not limited to, the following instructions for safe tractor operation.



WARNING: An operator should not use alcohol or drugs which can affect his alertness or co-ordination. An operator on prescription or 'over the counter' drugs needs medical advice on whether or not he or she can safely operate machines.

Observe the Following

- **DO NOT** allow children or unqualified persons to operate your tractor. Keep others away from your area of work.
- Securely fasten your seat belt when the tractor has a ROPS (Roll Over Protective Structure) frame in the upright position or is fitted with a cab.
- Where possible, avoid operating the tractor near ditches, embankments and holes. Reduce speed when turning, crossing slopes, and on rough, slippery, or muddy surfaces.
- Stay off slopes too steep for safe operation.
- Watch where you are going, especially at row ends, on roads, and around trees.
- **DO NOT** permit others to ride on the tractor or the implement unless an approved passenger seat and seat belt is fitted.
- Hitch only to the drawbar and hitch points recommended, and never above the centre line of the rear axle.
- Operate the tractor smoothly - no jerky turns, starts or stops. When the tractor is stopped, apply the parking brake securely. Lower the implement and remove the key.
- **DO NOT** modify or remove any part of the equipment and **DO NOT** use attachments unless they are properly matched to your tractor.

Safety Notes

Protective Structures

Roll Over Protective Structures

A Roll Over Protective Structure (ROPS) and seat belt is fitted as standard equipment to the footstep tractor at the time of factory assembly. If the ROPS was removed by the original purchaser or has been removed, it is recommended that you equip your tractor with a Roll Over Protective Structure and a seat belt. ROPS are effective in reducing injuries during overturn accidents. Overturning a tractor without ROPS can result in serious injury or death (Fig. 5).

If a fold down ROPS is installed **DO NOT** wear seat belt when the ROPS is in the folded down position.

Operation

- Before using the tractor ensure that the ROPS frame is not damaged, that it is securely fastened to the tractor and if a hinged section is fitted that it is in the raised position and secured.
- If the ROPS has been removed from the tractor, or folded down for a specific operation, it must be refitted or erected immediately afterwards using the proper hardware and applying the recommended torque values.
- **DO NOT** attach chains, ropes, or cables to the ROPS for pulling purposes; this will cause the tractor to tip backwards. Always pull from the tractor drawbar.
- Always wear your seat belt - adjusted snugly except when operating with a folded down ROPS.
- Check the seat belt for damage. A damaged seat belt must be replaced (Fig. 6).

Damage to the ROPS

If the tractor has rolled over or the ROPS has been damaged (such as striking an overhead object during transport), the ROPS must be replaced to provide the original degree of protection.

After an accident, check for damage to the ROPS, operator's seat, seat belt and seat belt mountings. Before you operate the tractor, replace all damaged parts.

DO NOT WELD, DRILL, BEND OR STRAIGHTEN THE ROPS. To do so reduces the protection it offers.

Cab

The safety cab has been designed for fitment to this series of tractor and meets all the legal requirements of cab safety and noise levels.

The safety cab conforms to the various international safety standards. The cab must **NEVER** be drilled, or modified to install accessories or implements. Welding components to the cab or repairing damaged components is **NOT PERMITTED**. **DO NOT** attach chains or ropes to the main frame of the cab for pulling purposes.

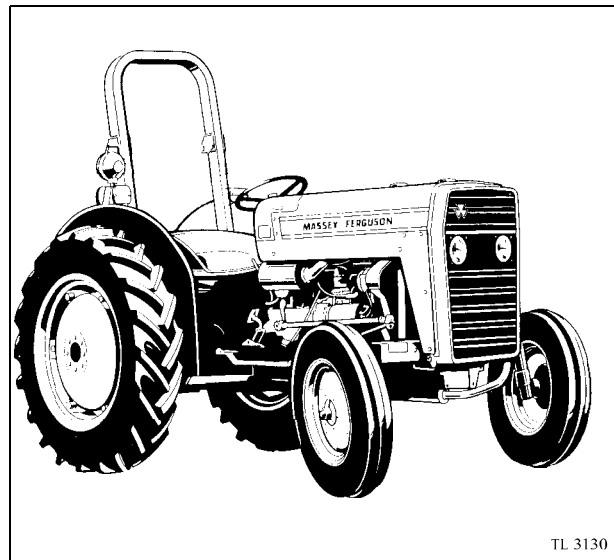

Fig. 5

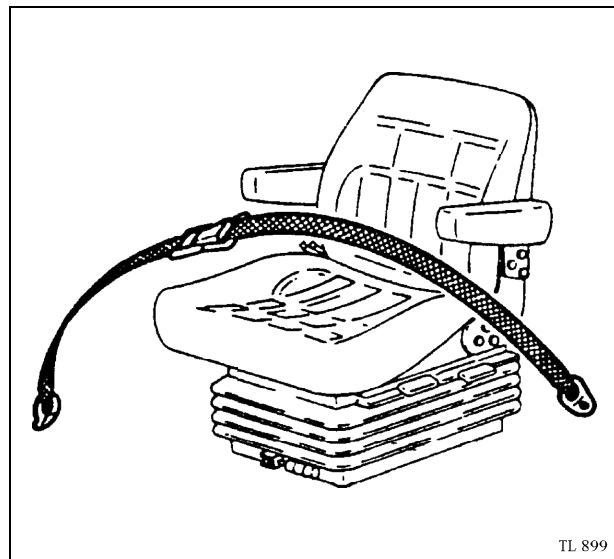

Fig. 6

If additional controls or displays are to be added to the operator's area contact your Massey Ferguson Dealer for information as to how this can best be done.

The ROPS cab together with the seat belt is effective in reducing injuries during overturn accidents. Wearing the seat belt is an important part of this protection.

- Always wear your seat belt - adjusted snugly.
- Check the seat belt for damage. A damaged seat belt must be replaced (Fig. 6).

Prepare for Safe Operation

Protect Yourself

Wear all the protective clothing and personal safety devices issued to you or called for by job conditions. Don't take chances (Fig. 7).

You may need:

- A hard hat.
- Safety glasses, goggles, or face shield.
- Hearing protection.
- Respirator or filter mask.
- Foul weather clothing.
- Reflective clothing.
- Heavy gloves (neoprene for chemicals, leather for rough work).
- Safety boots.

DO NOT wear loose clothing, jewellery or other items and tie up long hair which could entangle in controls or other parts of the tractor.

Note where fire extinguishers and first-aid or emergency equipment is kept and get to know where to find help in a hurry. Make sure you know how to use this equipment (Fig. 8).

Know Your Equipment

Know your tractor. Know how to operate all equipment on your machine and the implements and attachments used with it. Know the purpose of all the controls, gauges and dials. Know the rated load capacity, speed range, braking and steering characteristics, turning radius, and operating clearances.

Keep in mind that rain, snow, ice, loose gravel, soft ground, etc. can change the way your tractor operates.

Under poor conditions, slow down and be extra careful, engage four-wheel drive, if fitted.

Study the **DANGER**, **WARNING**, or **CAUTION** safety signs on your tractor and the information signs also.

READ THIS OPERATOR INSTRUCTION BOOK BEFORE STARTING THE ENGINE.

STUDY IT BEFORE YOU START WORK (Fig. 9).

IF THERE IS SOMETHING IN THE MANUAL YOU DON'T UNDERSTAND, ASK SOMEONE (such as your equipment Dealer) TO EXPLAIN IT TO YOU.

IMPORTANT: This manual covers general safe practices for agricultural tractors. It must always be kept with the tractor. For further copies contact your Massey Ferguson Dealer.

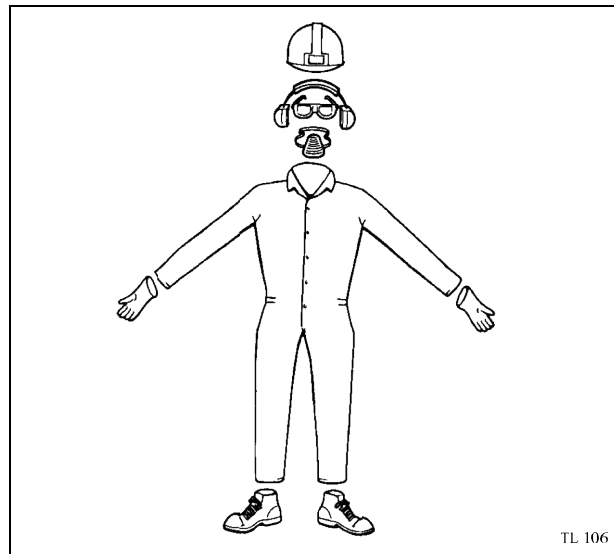

Fig. 7



Fig. 8

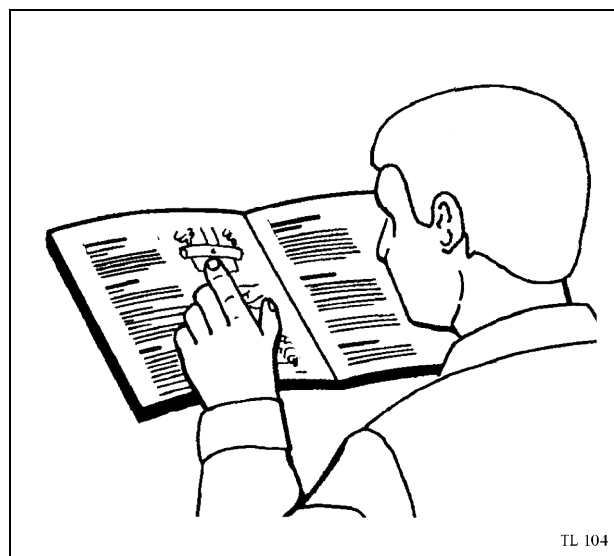

Fig. 9

Safety Notes

Use all Available Protective and Safety Devices

Keep all protective devices in place and securely fastened. Make certain all guards, shields and safety signs are properly installed, as specified, and are in good condition.

To help keep you and others around you safe, your tractor must be equipped with:

- Roll Over Protective Structure (ROPS), and seat belt.
- Tractor PTO shield.

Your tractor may also need:

- Rear view mirror.
- Fire extinguisher.
- ROPS, FOPS (Falling Object Protective Structure), protective enclosure or protective screens (Fig. 10). Remember FOPS are protection from light falling objects and are not intended as protection from large falling objects such as large round bales or fence rails.
- SMV (slow moving vehicle) emblem, additional safety guards, lights or decals and a back up alarm.

Know which devices are required for safe operation of your tractor. Use them. Make sure they are in place and in good condition. **DO NOT** remove or disconnect any safety device.

Check the Equipment

Before you begin your working day, take time to check your tractor and ensure that all systems are in good operational condition.

- **DO NOT** smoke while refuelling the tractor. Keep any type of open flame away (Fig. 11).
- Stop the engine and wait for it to cool before refuelling.
- Check for loose, broken, missing, or damaged parts. Have everything put into good repair. Make certain all safety devices are in place.
- Check ROPS and seat belt for damage. A damaged ROPS or seat belt (see Fig .6) **MUST** be replaced.
- Ensure that implements and attachments are properly installed and that the tractor and implement PTO rev/min ratings match.
- Check the tyres for cuts, bulges and correct pressure. Replace worn or damaged tyres.
- Check the engine oil level and add oil if required.
- Perform all maintenance procedures outlined in the maintenance and adjustment section of this manual.
- Check foot and parking brakes for proper operation, adjust if necessary.

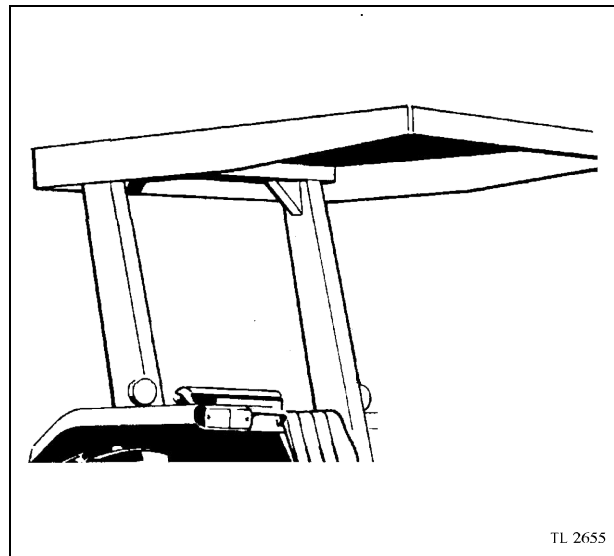

Fig. 10



Fig. 11

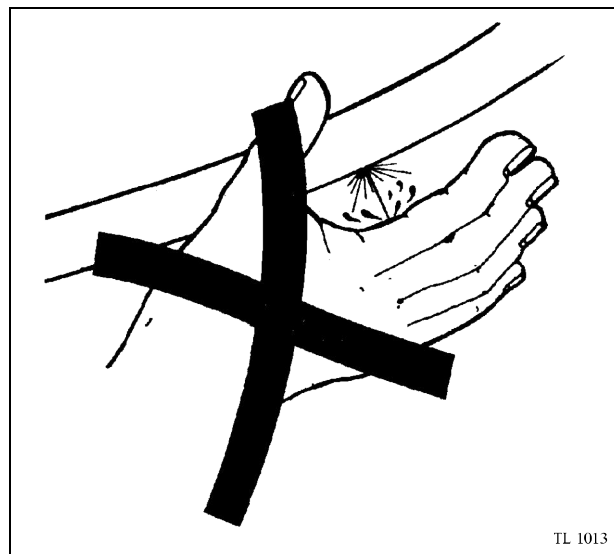

Fig. 12

- Check that the PTO driveline locking devices are latched.
- Check that the tractor PTO shield and driveline guards are in place and operating properly.
- Check the tractor and implement hydraulic system. Have any leaks or damaged parts repaired or replaced.



WARNING: Diesel fuel or hydraulic fluid under pressure can penetrate the skin or eyes and cause serious personal injury, blindness or death. Fluid leaks, under pressure, may not be visible. Use a piece of cardboard or wood to find leaks. **DO NOT** use your bare hand. Wear safety goggles for eye protection. If any fluid is injected into the skin, it **MUST** be surgically removed within a few hours by a doctor familiar with this type of injury (see Fig. 12).

Before applying pressure to the fuel or hydraulic system, be sure all connections are tight and that lines, pipes, and hoses are not damaged. Before disconnecting fuel or hydraulic lines, be sure to relieve all pressure.

Make sure that all hydraulic lines are correctly installed and not crossed.



WARNING: Liquid cooling systems build up pressure as the engine gets hot. Before removing the radiator cap, stop the engine and let the system cool.

- ▲ Check the engine cooling system and add coolant as required.

Clean the Tractor

- Keep work surfaces and engine compartments clean.
- Before cleaning the machine, always lower implements to the ground, place transmission in neutral, engage the parking brake, shut off the engine and remove the key.
- Clean steps, pedals and floor. Remove grease or oil. Brush away dust or mud. In winter, scrape away snow and ice. Remember - slippery surfaces are dangerous.
- Remove or put away tools, buckets, chains and hooks.

Protect the Environment

- It is illegal to pollute drains, water courses or soil. Use authorised waste disposal facilities, including civic amenity sites and garages providing facilities for disposal of used oil. If in doubt, contact your local authority for advice.



Fig. 13

Servicing the Tractor

- **DO NOT** service the tractor while the engine is running or hot, or if the tractor is in motion (Fig. 13).
- Before making adjustments to, or servicing the electrical system, disconnect the battery negative (-) cable first.
- To prevent fires or explosions keep open flame away from the battery or cold weather starting aids. To prevent sparks which could cause explosions use jump cables according to instructions.
- When making repairs or adjustments it is recommended that you consult your Massey Ferguson Dealer, and have the work carried out by trained personnel.
- The implement and/or tractor must be supported on suitable wooden blocks or stands. **NOT** a hydraulic jack.
- Check all nuts and bolts periodically for tightness, especially wheel hub and rim nuts. Tighten to the prescribed torque values.
- Check the brakes regularly, top up the reservoir and/or adjust where necessary. Make sure that the brakes are evenly adjusted, especially when using a trailer.

Thank you so much for reading.
Please click the “Buy Now!”
button below to download the
complete manual.



After you pay.

You can download the most
perfect and complete manual in
the world immediately.

Our support email:

ebooklibonline@outlook.com