



SAFETY NOTES

To ensure that machines entrusted to Authorised Service Centres for repair or overhaul continue to function correctly, it is very important that all repair work is carried out in the prescribed manner. The procedures for checks and repairs indicated in this manual are safe and effective.

Some of the operations described require the use of special tools and equipment: these tools have been designed for a specific purpose and may be ordered directly from the Manufacturers. **DO NOT USE MAKESHIFT TOOLS**; not only is there a risk of personal injury, but such tools are rarely suited to the purpose for which they are used.

To prevent injury to operators, the symbols  and  are used in this manual to indicate the safety precautions required. The warnings accompanying these symbols must always be adhered to carefully.

In potentially hazardous situations, always give priority to personal safety and take the necessary actions to eliminate the danger.

GENERAL SAFETY RULES

- 1 - Even if you have a thorough knowledge of the machine as regards its components, operation and controls, always take particular care when carrying out the following operations. Remember that the machine you are working on is in need of repair or overhaul and consequently may not always behave as expected.
- 2 - Before starting work, clean the machine thoroughly to remove all mud, dust and road dirt.
Also clean the cab to remove all traces of oil, snow and ice from the access steps and grab rails.
- 3 - When climbing up to or down from the cab, always ensure you maintain three points of contact at a time (foot or handholds) in order to keep your balance and prevent accidental falls.
- 4 - Always take special care when carrying out fault diagnosis operations; these operations often require two persons, who must never stand in front of the wheels when the engine is running.
- 5 - When carrying out checks and repairs, wear close-fitting clothing, safety goggles and protective gloves that are suitable for the task (cleaning, draining fluids, repairs).
When working near moving parts, long hair should be gathered up and secured safely under a cap to prevent the risk of entanglement and severe injury.
- 6 - Do not allow anyone who is not directly involved in the work to come near the machine; ensure that they remain at a safe distance.
- 7 - Keep well clear of moving parts; when the engine is running, some moving parts are not easily visible and therefore present a risk of entanglement, even if protected by safety guards.
- 8 - Ensure that the area is well ventilated before starting the engine in order to avoid the formation of dangerous concentrations of toxic gases; always connect suitable fume extraction equipment to the exhaust pipe.

- 9 - Under no circumstances start the engine with the safety guards removed; all repair and adjustment operations must be carried out with the engine stopped.
- 10 - Do not top up fuel, oil or coolant levels when the engine is running.
- 11 - Never smoke and ensure there are no naked flames nearby when topping up fuel or oil.
Always remove the battery from the machine before recharging.
- 12 - Before checking or removing the battery, stop the engine and remove the key from the starter switch.
- 13 - Remove the battery and recharge in a well-ventilated area where the temperature exceeds 0°C.
- 14 - When checking or recharging the battery, do not smoke or allow naked flames in the vicinity as the hydrogen gas given off by the battery is highly explosive.
- 15 - The liquid (electrolyte) contained in the battery is very harmful if it comes into contact with the skin and the eyes; for this reason, always wear gloves and safety goggles with side shields when checking or topping up the battery.
Should any electrolyte accidentally come into contact with your skin, wash the affected parts immediately with copious amounts of water. If electrolyte comes into contact with your clothing, this should be removed as soon as possible.
In case of accidental ingestion of electrolyte, drink copious amounts of water, milk or vegetable oil and take antacids such as magnesium, bicarbonate, etc.. and seek medical attention immediately.
- 16 - Before working on the electrical systems, always disconnect the battery terminals.
 **IMPORTANT!**
Always disconnect the negative terminal (-) first and then the positive terminal (+); when re-connecting the battery on completion of the work, first connect the positive terminal (+) and then the negative (-).
- 17 - Before carrying out any arc welding, on the tractor, always disconnect the battery terminals and unplug all the connectors of the electronic control units and the alternator.
- 18 - When topping up lubricants, always wear suitable protective gloves.
- 19 - Do not wear clothing contaminated by engine or hydraulic oil; prolonged contact with the skin can be harmful and may cause allergic reactions.
- 20 - Used engine oil and hydraulic oil must be disposed of in a proper manner; recover used lubricants and dispose of them in accordance with the applicable regulations.
- 21 - Before carrying out any work on the hydraulic or pneumatic systems, discharge all residual pressure from the circuits.
- 22 - Before carrying out any work on the hydraulic system or engine, allow the oil and engine coolant to cool down.

- 23 - When removing and refitting certain assemblies, it will be necessary to support the machine; use stands, jacks or blocks capable of supporting the weight and arrange them in a triangular pattern to prevent the machine from overturning.
- 24 - To lift heavy components, use a hoist or crane.
Check that wire ropes, chains or fibre slings are not worn and that hooks are not damaged.
- 25 - Always use lifting equipment of suitable capacity for the weight of the components to be removed. Ensure lifting equipment is attached correctly.
- 26 - When lifting or supporting an assembly or component, manoeuvre the parts slowly and carefully to avoid oscillation or collision with other components.
- 27 - Never work on components suspended from a hoist or crane.
- 28 - When removing the retaining bolts of a component that could fall, always leave two opposing bolts in place for safety; these bolts should only be removed when the component has been securely attached to a hoist or when supporting blocks have been put in position.
- 29 - Any oil or fuel spilled during removal or dismantling operations should be cleaned up as soon as possible to prevent the risk of slipping and fire.
- 30 - When refitting electrical wiring looms and wires, ensure that they are properly secured with their original retaining straps or brackets to prevent the possibility of damage caused by vibration.
- 31 - Never insert your fingers or hands to check the alignment between fixing holes in components; always use a suitable dowel of soft material.
- 32 - When refitting assemblies or components, always use the specified tightening torques; the tightening torques indicated in the paragraphs regarding assembly/refitting operations have been determined through experimentation and must be scrupulously adhered to.
- 33 - When refitting parts that are subject to vibration or that rotate at high speed, take particular care when carrying final installation checks.

SAFETY PRECAUTIONS FOR REMOVAL AND REFITTING OPERATIONS

- ★ When removing or refitting parts, always take the following safety precautions.

1. PRECAUTIONS FOR REMOVAL OPERATIONS

- Unless otherwise indicated, lower the working equipment until it rests on the ground.
- After disconnecting hydraulic and fuel system pipes, always fit plugs to the open ends of the pipes to prevent ingress of impurities.
- Before removing a cylinder, fully retract the piston and secure it in this position using a retaining strap.
- Use containers of sufficient capacity when draining oil, coolant or fuel.
- Before removing a part from the machine, check for alignment markings indicating the correct assembly position. If necessary, make new markings to ensure correct assembly.
- When unplugging electrical connectors, always grip the connectors firmly to avoid pulling on the wires.
- Where necessary, label wires and pipes before removal to avoid confusion when reconnecting.
- Check the number and thickness of any shims removed and keep them together in a safe place.
- To lift the machine or any of its main components, use lifting equipment of suitable capacity.
- When using eyebolts for lifting tractor components, first check that they are not deformed or damaged, screw them fully home and then turn the bolt so that the eye is aligned with the lifting hook.
- Before removing a part, clean the surrounding area and, after removing the part, cover it to prevent the ingress of dirt and dust.

2. PRECAUTIONS FOR REFITTING OPERATIONS

- Tighten nuts and bolts to the specified tightening torques.
- When refitting flexible pipes and wires, take care not to twist or tangle them.
- Always fit new seals, O-rings, cotter pins and safety stop rings on reassembly; make sure that the ends of the cotter pins are separated and bent back so that the pin cannot be withdrawn from the hole.
- Ensure that circlips are correctly installed in their seatings.
- Always fit new seals, O-rings, cotter pins and safety stop rings; ensure that cotter pins are bent over so that they cannot work loose.
- When applying sealant, first clean the surface removing all traces of oil and grease and check for dirt or indentations, then apply the sealant evenly making sure that it forms a continuous film around any fixing holes.
- Clean all parts, removing dirt, oxidisation, carbon deposits, burrs and indentations.

- Coat all moving parts with a thin film of engine oil.
- When reconnecting electrical connectors, first remove all traces of oil, dust and water from the inside of the connector and then push the two halves together firmly; only apply the force necessary to clip the two halves together.
- Bolt down flanged fittings evenly, tightening the bolts gradually in a cross-wise pattern.

3. PRECAUTIONS TO BE TAKEN ON COMPLETION OF REMOVAL/REFITTING OPERATIONS

- If coolant has been drained from the engine, refit the drain plug and add new coolant to the correct level. Start the engine to circulate the coolant and then check the level again and top up.
- After removing hydraulic components, top up the hydraulic oil to the specified level. Start the engine to circulate the oil in the hydraulic circuits and then recheck the level and top up as necessary.
- After having removed a variable displacement pump, connect the drain pipe and fill the pump casing with oil through the filler hole provided.
- Grease stub axle housings, cylinder pivot mountings and drive shafts thoroughly after assembly.

LIFTING INSTRUCTIONS

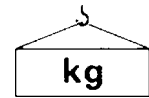

! Components weighing over 25 kg or of significant size must be supported and removed using suitable lifting equipment with wire rope or polyester slings.
 In the paragraphs regarding removal and refitting operations, the weight of the component or assembly to be lifted is indicated with the symbol kg

WIRE ROPES - SLINGS

- Use wire ropes or polyester slings of suitable capacity for the parts to be lifted, referring to the following tables:

WIRE ROPES (standard twisted «S» or «Z» type)				POLYESTER SLINGS (eye-and-eye - simple loop)				
Ø rope mm	Capacity (kg)			Width (mm)	Capacity (kg)			
8	650	620	500	25	500	400	860	700
10	1000	1740	1420	50	1000	800	1730	1410
12	1450	2500	2050	62	1250	1000	2160	1760
14	2000	3460	2820	75	1400	1120	2420	1980
16	2600	4500	3670	100	2000	1600	3460	2820
18	3300	5710	4660	150	2500	2000	4330	3530

NOTE. Lifting capacities are calculated with a safety coefficient.

- The lifting hook should be attached to the central part of the rope or sling; if the hook is attached near the ends of the rope/sling, this could cause the load to slip during lifting.
- Never lift a heavy load using a single rope; always use two or more symmetrically arranged ropes.
- !** Suspension of a load from a single rope could cause the load to start rotating and consequently cause the rope strands to untwist or the load to slip; this could lead to serious injury.
- Never lift a heavy load when the two branches of the ropes form a wide angle.
 The permitted load (kg) decreases in inverse proportion to the angle of suspension; the table below indicates how the permitted load varies according to the angle of suspension for two Ø 10 mm ropes each with a load capacity of 1000 kg.

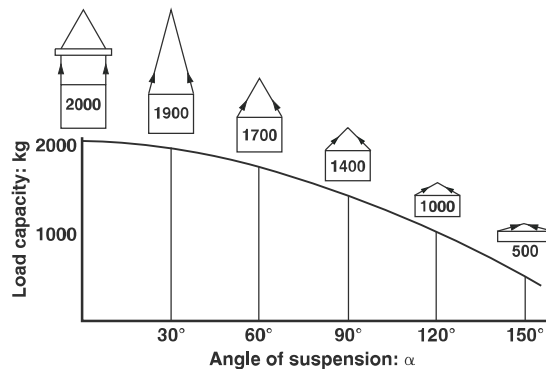

HOW THE MANUAL IS STRUCTURED

- Section 00** Contains the general safety rules, information on how to use and update the manual, the symbols used, the products required, the standard tightening torques and a conversion table for units of measurement.
- Section 10** Contains technical descriptions and information regarding the mechanical and hydraulic operation of machine components, the designations of the various components, hydraulic diagrams and general technical data.
- Section 30** Contains the methods, checks and adjustments regarding the external components; the operations dealt with in this section do not require removal of the various assemblies that form the tractor frame and cab.
- Section 40** Contains information and diagrams regarding the machine's electrical and electronic systems.
- Section 50** This section contains the procedures regarding the removal and overhaul of the engine .

HOW TO CONSULT THE MANUAL

1. Removal and refitting of assembled units

- (1) For the removal or refitting of assembled units, the sequence of operations and the methods to be applied are described in the removal procedure; if the refitting sequence of operations is the exact reverse of the removal procedure, it is not described.
- (2) All special techniques that apply only to the refitting procedure are indicated by the symbol ; this same symbol appears at the end of each major step in the removal procedure to indicate the parts for which special techniques are to be applied during refitting.

E.g.: **REMOVAL OF UNIT** : Operation heading

 : Safety rules to be observed when carrying out the procedure described

1 - Remove part (1):..... Step of the procedure

★: Technique or important information regarding the removal operation.

2 - Disconnect (2)  : Indicates the existence of special information regarding refitting of the component in question.

 ℓ: Recover oil, liquid or fuel and the quantity to be recovered

E.g.: **REFITTING UNIT**: Operation heading

- Refitting is the reverse of removal

 : Technique to be applied during refitting

★: Technique or important information regarding the refitting operation

•  ℓ: Filling with oil or liquid with quantity

2. During removal and refitting operations, in addition to the general safety rules, you must also apply the specific «SAFETY PRECAUTIONS FOR REMOVAL AND REFITTING OPERATIONS». Always adhere to these precautions.

3. List of special tools

- (1) For details regarding the type, code numbers and quantity of all the tools (T1, T2, etc.) specified in the operating procedures, see the heading «SPECIAL TOOLS».

4. Tightening torques

- 1 - In the operating procedures, the symbol  denotes a specific tightening torque that has been determined experimentally and that must be adhered to.
- 2 - If the symbol does not appear, the torque values to be used are those indicated in the table in Section 00 of this manual.

HOW TO USE AND UPDATE THE MANUAL

1. UPDATING THE MANUAL

All additions, corrections or amendments to the manual will be sent to the Authorised Service Centres.

Before starting any repair or overhaul operations, check that you have the most recent updates as these may contain supplementary data not present in previous issues.

2. INSERTING UPDATES

1- **Check the** number of the page and insert it in the appropriate section of the manual following the consecutive order of the page numbers. Example:

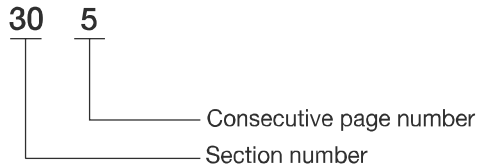

2 - **Supplementary pages:** indicated with a hyphen (-) and consecutive number after the page number. Example:

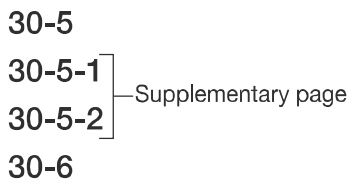

NOTE. The contents of supplementary pages are structured so that there is no overlap with existing pages.

3 - **Updated pages:** indicated by a consecutive number in a circle; this symbol appears below the page number. Example:

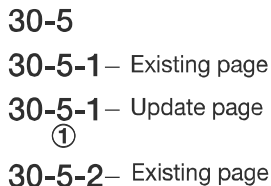

NOTE. All supplementary and updated pages are indicated in the manual page list; a revised page list is sent with each update and supersedes the previous list.

3. SYMBOLS USED IN THE MANUAL

For greater clarity, important information pertaining to operator safety and to critical stages in the working procedures is highlighted by the symbols shown in the following table.

Symbol	Meaning	Notes	Symbol	Meaning	Notes
	Safety	Safety rules to be applied during operation.		Coating	Parts must be coated with adhesive, lubricant, etc.
		Operation requiring special safety measures due to internal pressure.		Oil, water	Points at which oil, water or fuel must be added and quantity required.
	Warning	Operations requiring special technical or other precautions to ensure compliance with standard values.		Drain	Points from which oil, water or fuel must be drained with quantity.
	Weight	Weight of main assemblies. Choose lifting ropes/slugs carefully; supports required, etc.		Tightening torques	Parts requiring special tightening torque during refitting or assembly.

STANDARD TIGHTENING TORQUES FOR NUTS AND BOLTS

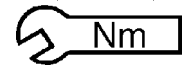

! The tightening torques for certain specific components and special tightening methods are indicated in the relative assembly paragraphs.

★ The tightening torques indicated below refer to bolts and nuts assembled without lubrication and, where applicable, with anaerobic threadlocking compound.
The values apply to tightening on steel or cast iron components; for soft materials such as aluminium, copper, plastic, sheet metal or panels, the indicated tightening torques must be reduced by 50%.

BOLT SIZE		BOLT CLASS					
		8.8		10.9		12.9	
		Nm	lb.ft.	Nm	lb.ft.	Nm	lb.ft.
COARSE THREAD	M6x1	8.0–8.8	5.9–6.5	11.8–13.0	8.7–9.6	13.8–15.2	10.2–11.2
	M8x1.25	19.4–21.4	14.3–15.8	28.5–31.5	21.0–23.2	33.3–36.9	24.5–27.2
	M10x1.5	38.4–42.4	28.3–31.2	56.4–62.4	41.6–46.0	67.4–74.4	49.7–54.8
	M12x1.75	66.5–73.5	49.0–54.2	96.9–107	71.4–78.9	115–128	84.8–94.3
	M14x2	106–117	78.1–86.2	156–172	115.0–126.8	184–204	135.6–150.3
	M16x2	164–182	120.9–134.1	241–267	117.6–196.8	282–312	207.8–229.9
	M18x2.5	228–252	168.0–185.7	334–370	246.2–272.7	391–432	288.2–318.4
	M20x2.5	321–355	236.6–261.6	472–522	347.9–384.7	553–611	407.6–450.3
	M22x2.5	441–487	325.0–358.9	647–715	476.8–527.0	751–830	553.5–611.7
	M24x3	553–611	407.6–450.3	812–898	598.4–661.8	950–1050	700.2–773.9
M27x3	816–902	601.4–664.8	1198–1324	882.9–975.8	1419–1569	1045.8–1156.4	
FINE THREAD	M8x1	20.8–23.0	15.3–17.0	30.6–33.8	22.6–24.9	35.8–39.6	26.4–29.2
	M10x1.25	40.6–44.8	29.9–33.0	59.7–65.9	44.0–48.6	71.2–78.6	52.5–57.9
	M12x1.25	72.2–79.8	53.2–58.8	106–118	78.1–87.0	126–140	92.9–103.2
	M12x1.5	69.4–76.7	51.1–56.5	102–112	75.2–82.5	121–134	89.2–98.8
	M14x1.5	114–126	84.0–92.9	168–186	123.8–137.1	199–220	146.7–162.1
	M16x1.5	175–194	129–143	257–285	189.4–210.0	301–333	221.8–245.4
	M18x1.5	256–282	188.7–207.8	375–415	276.4–305.9	439–485	323.5–357.4
	M20x1.5	355–393	261.6–289.6	523–578	385.5–426.0	611–676	450.3–498.2
	M22x1.5	482–532	355.2–392.1	708–782	521.8–576.3	821–908	605.1–669.2
	M24x2	602–666	443.7–490.8	884–978	651.5–720.8	1035–1143	762.8–842.4

THREADLOCKERS, ADHESIVES, SEALANTS AND LUBRICANTS



FUNCTION	DESIGNATION	DESCRIPTION
THREADLOCKER	Loctite 222 Colour: opaque fluorescent purple	Anaerobic product suitable for low-strength locking of retaining, adjustment and precision fasteners. All traces of lubricant must first be removed using the specific activator.
	Loctite 242 Colour: fluorescent blue	Anaerobic product that prevents loosening of all types of nut and bolt; used in place of conventional mechanical locking systems. Used for medium-strength locking. All traces of lubricant must first be removed using the specific activator.
	Loctite 243 Colour: opaque fluorescent blue	Alternative product to 242; oil tolerant and so can be used on lightly lubricated surfaces without prior use of activator.
	Loctite 270 Colour: fluorescent green	Anaerobic product for high-strength locking of bolts and studs that do not normally require disassembly. Parts must be heated to approximately 80°C for removal. All traces of lubricant must first be removed using the specific activator.
DEGREASERS AND ACTIVATORS	Loctite 703	Product used for degreasing and cleaning parts prior to application of Loctite anaerobic products; after drying, promotes uniform curing of threadlockers.
	Loctite 747	Product used specifically for treatment of passive metals prior to use of slow-cure anaerobic threadlockers (series 5 and 6). Can also be used to increase cure speed at low temperatures or in applications where there are large gaps between the parts.
SEALANTS (for faces and flanges)	Loctite 510 Colour: red	Super-rapid anaerobic sealant for sealing between rigid metal faces; can eliminate the need for conventional gaskets as it can fill gaps up to 0.4 mm. Does not shrink and therefore fasteners do not need re-tightening to specified torque values after curing.
	Loctite 542 Colour: brown	Anaerobic product used as a liquid sealant for threaded fittings up to 3/4" gas; rapid curing and parts may be disassembled with ordinary tools.
	Loctite 554 Colour: red	Anaerobic sealant and locking compound used for sealing cooling and industrial fluid circuits. Slow curing, also suitable for use on non-ferrous alloys.
	Loctite 572 Colour: white	Anaerobic sealant and locking compound used for sealing pipes and threaded fittings up to 2" in diameter. Very slow curing on most metal surfaces.
	Loctite 573 Colour: green	Thixotropic anaerobic product used for sealing joints between metal faces. Ensures total contact between surfaces with maximum tolerance of 0.10 mm, filling microvoids caused by flatness errors. Very slow curing on most metal surfaces and requires prior application of an activator.
	Loctite 576 Colour: brown	Anaerobic product used as a liquid thread sealant for large diameter threaded fittings (up to 2"). Very slow curing; also suitable for non-ferrous alloys and parts requiring subsequent removal.

THREADLOCKERS, ADHESIVES, SEALANTS AND LUBRICANTS

FUNCTION	DESIGNATION	DESCRIPTION
INSTANT ADHESIVES	Loctite 401 Colour: colourless	Cyanoacrylate instant adhesive suitable for bonding a wide range of acidic and porous materials including, ceramics, wood, rubber and plastic (excluding polyolefin). Curing takes place in a few seconds as an effect of the condensed humidity present on the surfaces to be bonded, and is independent of environmental conditions.
	Loctite 495 Colour: colourless	Cyanoacrylate instant adhesive suitable for bonding a rubber, plastics and metal in any combination.
SILICONE SEALANTS	Silastic 738 (Dow Corning) Colour: milky white	One-part silicone adhesive/sealant, ready for use. Cures on exposure to air to form a rubbery solid and obviates the need for conventional seals on flexible joints, filling gaps greater than 1 mm.
	Dirko Transparent Colour: transparent	One-part silicone adhesive/sealant, shrinking, ready for use. Cures rapidly when exposed to humidity in the air to form a rubbery solid; resistant to high temperatures.
POLYURETHANE SEALANTS	Betaseal HV3 (Gurit Essex) Colour: black	Polyurethane prepolymer based adhesive/sealant, high viscosity, suitable for permanent, high-strength flexible bonding. Slow curing, used for bonding glass to frames, wire mesh, metal plates, etc. surfaces must be degreased with primer.
RETAINING COMPOUNDS	Loctite 601 Colour: fluorescent green	Anaerobic, fast-curing, high-strength adhesive. Suitable for sealing and retaining cylindrical assemblies with gap clearances of up to 0.10 mm; used for retaining rotors, gears, bearings, pulleys, bushes etc. on shafts.
	Loctite 638 Colour: fluorescent green	Anaerobic structural adhesive, quick-curing, very high strength; suitable for bonding cylindrical parts in non-ferrous alloys.
	Loctite 648 Colour: fluorescent green	Anaerobic structural adhesive, quick-curing, high-strength; suitable for bonding cylindrical parts, permanent retention of threaded parts, sealing of refrigeration systems, retention of bearings, etc. Alternative to Loctite 601 in high-temperature applications.
	Loctite 986/AVX Colour: fluorescent red	Anaerobic sealant/retaining compound for metal cylindrical parts. Slow-curing, high-strength, heat-resistant and resistant to chemical pressure. Parts must be first treated with an activator.
LUBRICANTS	Grease (NLGI 2 EP ASTM D217: 265/295)	Multi-purpose Lithium grease used for lubrication of seals, to prevent oxidization and to facilitate assembly operations.
	Molikote (Dow Corning)	Anti-wear compound, contains Molybdenum bisulphate, use neat or diluted with engine oil for assembly of main engine bearings.
	Vaseline	Neutral pH compound used to protect battery terminals against oxidization and corrosion.
	Engine oil 10W - 30	Used to dilute Molikote anti-wear lubricant during assembly of main engine bearings.

CONVERSION FACTORS

CONVERSION FROM BRITISH TO METRIC UNITS

inch x 25,40	= mm
foot x 0,305	= m
yard x 0,914	
Eng.miles x 1,609	= km
Sq.in. x 6,452	= cm ²
Sq.ft. x 0,093	= m ²
Sq.yard x 0,835	
Cu.in. x 16,39	= cm ³
Cu.ft. x 28,36	= m ³
Cu.yard x 0,763	
Imp.gall. x 4,547	= litres
US gall. x 3,785	
pint x 0,568	
quart x 1,137	
US.gpm x 3,785	= ℓ/min
oz. x 0,028	= kg
lb. x 0,454	
lb.ft. x 0,139	= kgm
lb.in. x 17,87	= kg/m
psi x 0,070	= kg/cm ²
lb./Imp.gall x 0,100	= kg/ℓ
lb./US.gall x 0,120	
lb./cu.ft. x 16,21	= kg/m ³
lb.ft. x 1,356	= Nm
psi x 1,379	= bar

CONVERSION FROM METRIC TO BRITISH UNITS

mm x 0,0394	= inch
m x 3,281	= foot
m x 1,094	= yard
km x 0,622	= Eng.miles
cm ² x 0,155	= Sq.in.
m ² x 10,77	= Sq.ft.
m ² x 1,197	= Sq.yard
cm ³ x 0,061	= Cu.in.
m ³ x 0,035	= Cu.ft
m ³ x 1,311	= Cu.yard
litres x 0,220	= Imp.gall.
litres x 0,264	= US gall.
litres x 1,762	= pint
litres x 0,880	= quart
ℓ/min x 0,2642	= US.gpm
kg x 35,25	= oz.
kg x 2,203	= lb.
kgm x 7,233	= lb.ft.
kg/m x 0,056	= lb.in.
kg/cm ² x 14,22	= psi
kg/ℓ x 10,00	= lb./Imp.gal.
kg/ℓ x 8,333	= lb./US.gal.
kg/m ³ x 0,062	= lb./cu.ft.
Nm x 0,737	= lb.ft.
bar x 14,503	= psi

SECTION 10

CONTENTS

1. TRANSMISSION	1	3. CONTROLS	14
• 1.1 INTRODUCTION	1	• 3.1 RIGHT-HAND SIDE VIEW	14
• 1.2 DESCRIPTION	2	• 3.2 LEFT-HAND SIDE VIEW	15
• • 1.2.1 DRIVE TRANSMISSION	3	• 3.3 TOP VIEW	16
• 1.3 CLUTCH HOUSING	4	4. HYDRAULIC SYSTEM	17
• 1.4 GEARBOX AND SHUTTLE ASSEMBLY.....	5	• 4.1 DESCRIPTION	17
• 1.5 4WD RANGE GEARS ASSEMBLY.....	6	• 4.2 HYDRAULIC DIAGRAM	18
• 1.6 PINION AND DIFFERENTIAL ASSEMBLY	7	• 4.3 STEERING CIRCUIT	19
• 1.7 BRAKES AND REAR AXLE ASSEMBLY	8	• • 4.3.1 FUNCTION	19
• 1.8 REAR PTO AND MID PTO	9	• • 4.3.2 OPERATION.....	19
• • 1.8.1 COMPONENTS.....	9	• • 4.3.3 GEAR PUM	20
• • 1.8.2 MAIN COMPONENTS	10	• • 4.3.4 POWER STEERING.....	21
2. FRONT AXLE:	11	• • 4.3.5 DIFFERENTIAL LOCK CONTROL ASSEMBLY.....	23
• 2.1 STEERING CYLINDER.....	12	• • 4.3.6 AUXILIARY SERVICES CONTROL VALVE (4 WAYS)	25
• 2.2 DIFFERENTIAL- PINION - FINAL DRIVE.....	13	• • 4.3.7 POWER LIFT CONTROL VALVE	26

1. TRANSMISSION

1.1 INTRODUCTION

- The tractors in this series are equipped with a 4-speed transmission with forward/reverse shuttle and three speed ranges.
The main gearbox and the forward/reverse shuttle are synchronised, while the 3-speed range gearbox is not synchronised.
- The rear transmission casing also houses the drive train for the rear PTO, which is supplied in a single version (540-1000-groundspeed).
The rear PTO is of the mechanical type with non-synchronised gears.
The PTO can also be supplied with a mid-mounted output shaft that is only enabled when the 1000 rpm PTO speed is selected.

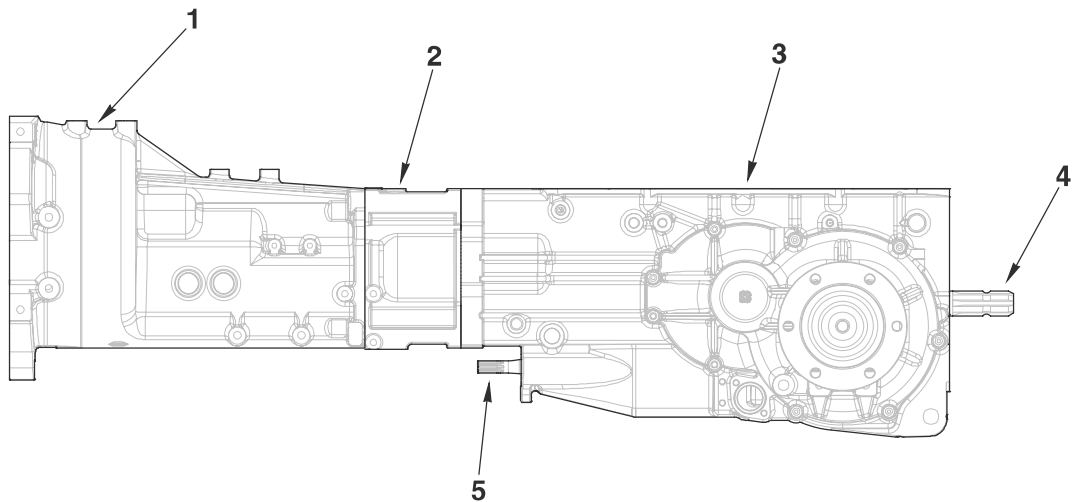

D0018450

MAIN ASEMBLIES

- 1 - Clutch housing
- 2 - Shuttle gearbox assembly
- 3 - Range gearbox and differential assembly
- 4 - Rear PTO
- 5 - Mid PTO

1.2 DESCRIPTION

- The transmission receives drive from the engine and transmits it through the dual clutch assembly (1) (main drive clutch (1a) and rear PTO clutch (1b)), the main gearbox (3), the shuttle (2) and the range gearbox (4) to the bevel drive gears (5). Drive is then transmitted to the final drive units (6) which mount the brake assemblies providing both service brake and parking brake functions.

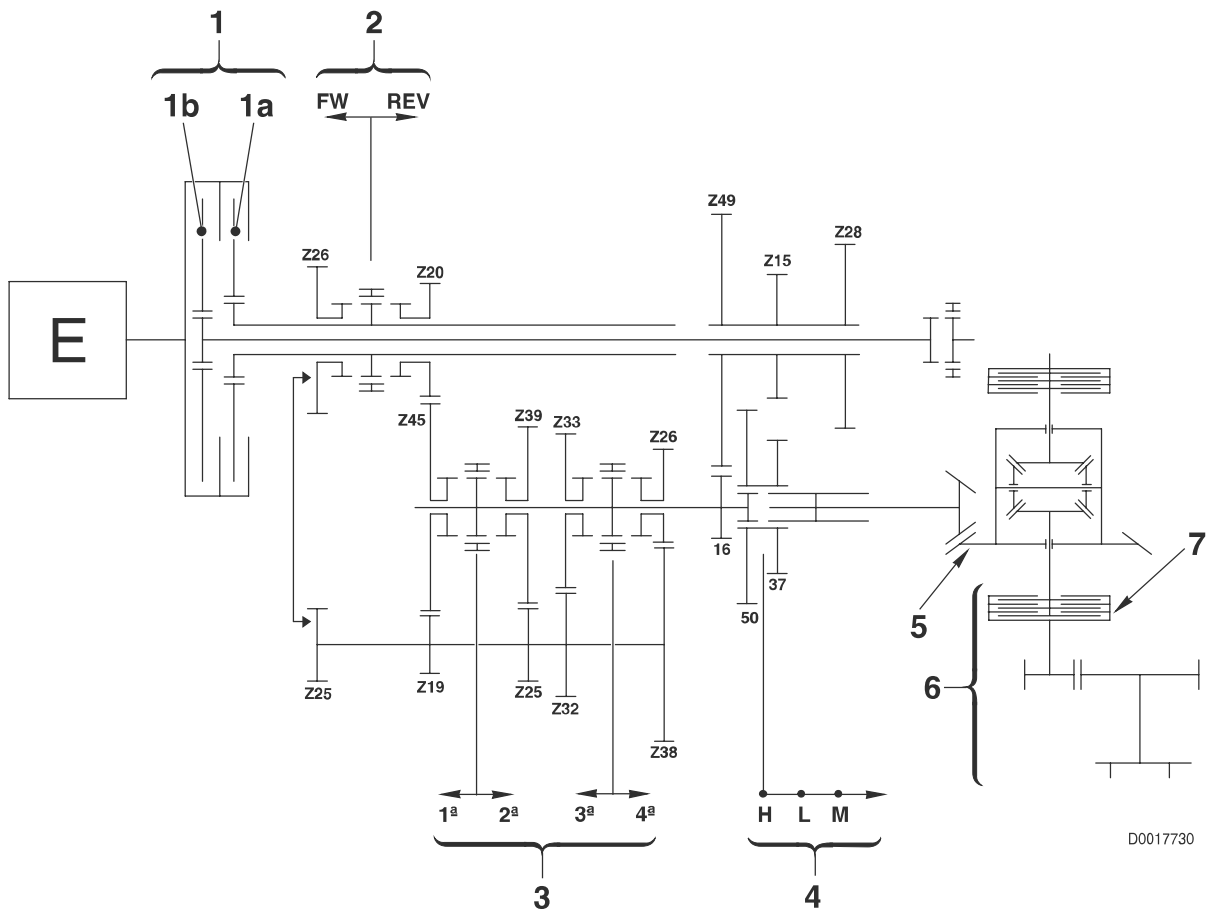

D0017730

Thank you so much for reading.
Please click the “Buy Now!”
button below to download the
complete manual.



After you pay.

You can download the most
perfect and complete manual in
the world immediately.

Our support email:

ebooklibonline@outlook.com