

**A8000**  
**A8800**  
**Cane Harvester**  
*from PIN PRCY8000CFPA02521*  
*from PIN PRCY8800CFPA02520*

**SERVICE MANUAL**

Part number 47905426

English

June 2016

© 2016 CNH industrial Latin America LTDA. All Rights Reserved.





## SERVICE MANUAL

8000 FPT engine, TIER 3 [PRCY8000CFPA02521 - ], 8000 FPT engine, TIER 3 [PRCY8000CFPA02521 - ], 8000 FPT engine, TIER 3 [PRCY8000CFPA02521 - ], 8000 FPT engine, TIER 0 [PRCY8000CFPA02521 - ], 8000 FPT engine, TIER 3 [PRCY8000CFPA02521 - ], 8800 FPT engine, TIER 3 [PRCY8800CFPA02520 - ], 8800 FPT engine, TIER 3 [PRCY8800CFPA02520 - ], 8800 FPT engine, TIER 3 [PRCY8800CFPA02520 - ], 8800 FPT engine, TIER 0 [PRCY8800CFPA02520 - ], 8800 FPT engine, TIER 3 [PRCY8800CFPA02520 - ]

# Link Product / Engine

Product	Market Product	Engine
8000 Motor FPT, TIER 3 [PRCY8000CFPA02521 - ]	Middle East Africa	F2CE0684A*D003
8000 Motor FPT, TIER 3 [PRCY8000CFPA02521 - ]	Australia New Zealand	F2CE0684A*D003
8000 Motor FPT, TIER 3 [PRCY8000CFPA02521 - ]	Asia Pacific	F2CE0684A*D003
8000 Motor FPT, TIER 3 [PRCY8000CFPA02521 - ]	North America	F2CE0684A*D003
8000 Motor FPT, TIER 3 [PRCY8000CFPA02521 - ]	Latin America	F2CE0684A*D003
8000 Motor FPT, TIER 3 [PRCY8000CFPA02521 - ]	North America	F2CE9684H*E041
8000 Motor FPT, TIER 3 [PRCY8000CFPA02521 - ]	Asia Pacific	F2CE9684H*E041
8000 Motor FPT, TIER 3 [PRCY8000CFPA02521 - ]	Latin America	F2CE9684H*E041
8000 Motor FPT, TIER 3 [PRCY8000CFPA02521 - ]	Australia New Zealand	F2CE9684H*E041
8000 Motor FPT, TIER 3 [PRCY8000CFPA02521 - ]	Middle East Africa	F2CE9684H*E041
8000 Motor FPT, TIER 3 [PRCY8000CFPA02521 - ]	Latin America	F2CE9684H*E041
8000 Motor FPT, TIER 3 [PRCY8000CFPA02521 - ]	Australia New Zealand	F2CE9684H*E041
8000 Motor FPT, TIER 3 [PRCY8000CFPA02521 - ]	Asia Pacific	F2CE9684H*E041
8000 Motor FPT, TIER 3 [PRCY8000CFPA02521 - ]	North America	F2CE9684H*E041
8000 Motor FPT, TIER 3 [PRCY8000CFPA02521 - ]	Middle East Africa	F2CE9684H*E041
8000 Motor FPT, TIER 0 [PRCY8000CFPA02521 - ]	North America	F2CE0684A*D003
8000 Motor FPT, TIER 0 [PRCY8000CFPA02521 - ]	Latin America	F2CE0684A*D003
8000 Motor FPT, TIER 0 [PRCY8000CFPA02521 - ]	Middle East Africa	F2CE0684A*D003
8000 Motor FPT, TIER 0 [PRCY8000CFPA02521 - ]	Australia New Zealand	F2CE0684A*D003
8000 Motor FPT, TIER 0 [PRCY8000CFPA02521 - ]	Asia Pacific	F2CE0684A*D003
8000 Motor FPT, TIER 3 [PRCY8000CFPA02521 - ]	Australia New Zealand	F2CE9684H*E832
8000 Motor FPT, TIER 3 [PRCY8000CFPA02521 - ]	North America	F2CE9684H*E832
8000 Motor FPT, TIER 3 [PRCY8000CFPA02521 - ]	Latin America	F2CE9684H*E832
8000 Motor FPT, TIER 3 [PRCY8000CFPA02521 - ]	Asia Pacific	F2CE9684H*E832

<b>Product</b>	<b>Market Product</b>	<b>Engine</b>
8000 Motor FPT, TIER 3 [PRCY8000CFPA02521 - ]	Middle East Africa	F2CE9684H*E832
8800 Motor FPT, TIER 3 [PRCY8800CFPA02520 - ]	Australia New Zealand	F2CE0684A*D003
8800 Motor FPT, TIER 3 [PRCY8800CFPA02520 - ]	North America	F2CE0684A*D003
8800 Motor FPT, TIER 3 [PRCY8800CFPA02520 - ]	Latin America	F2CE0684A*D003
8800 Motor FPT, TIER 3 [PRCY8800CFPA02520 - ]	Middle East Africa	F2CE0684A*D003
8800 Motor FPT, TIER 3 [PRCY8800CFPA02520 - ]	Asia Pacific	F2CE0684A*D003
8800 Motor FPT, TIER 3 [PRCY8800CFPA02520 - ]	Latin America	F2CE9684H*E832
8800 Motor FPT, TIER 3 [PRCY8800CFPA02520 - ]	Middle East Africa	F2CE9684H*E832
8800 Motor FPT, TIER 3 [PRCY8800CFPA02520 - ]	Australia New Zealand	F2CE9684H*E832
8800 Motor FPT, TIER 3 [PRCY8800CFPA02520 - ]	Asia Pacific	F2CE9684H*E832
8800 Motor FPT, TIER 3 [PRCY8800CFPA02520 - ]	North America	F2CE9684H*E832
8800 Motor FPT, TIER 3 [PRCY8800CFPA02520 - ]	Latin America	F2CE9684H*E041
8800 Motor FPT, TIER 3 [PRCY8800CFPA02520 - ]	Asia Pacific	F2CE9684H*E041
8800 Motor FPT, TIER 3 [PRCY8800CFPA02520 - ]	Middle East Africa	F2CE9684H*E041
8800 Motor FPT, TIER 3 [PRCY8800CFPA02520 - ]	Australia New Zealand	F2CE9684H*E041
8800 Motor FPT, TIER 3 [PRCY8800CFPA02520 - ]	North America	F2CE9684H*E041
8800 Motor FPT, TIER 0 [PRCY8800CFPA02520 - ]	Latin America	F2CE0684A*D003
8800 Motor FPT, TIER 0 [PRCY8800CFPA02520 - ]	Asia Pacific	F2CE0684A*D003
8800 Motor FPT, TIER 0 [PRCY8800CFPA02520 - ]	Middle East Africa	F2CE0684A*D003
8800 Motor FPT, TIER 0 [PRCY8800CFPA02520 - ]	North America	F2CE0684A*D003
8800 Motor FPT, TIER 0 [PRCY8800CFPA02520 - ]	Australia New Zealand	F2CE0684A*D003
8800 Motor FPT, TIER 3 [PRCY8800CFPA02520 - ]	Latin America	F2CE9684H*E832
8800 Motor FPT, TIER 3 [PRCY8800CFPA02520 - ]	Middle East Africa	F2CE9684H*E832
8800 Motor FPT, TIER 3 [PRCY8800CFPA02520 - ]	Asia Pacific	F2CE9684H*E832
8800 Motor FPT, TIER 3 [PRCY8800CFPA02520 - ]	Australia New Zealand	F2CE9684H*E832
8800 Motor FPT, TIER 3 [PRCY8800CFPA02520 - ]	North America	F2CE9684H*E832

# Contents

---

## INTRODUCTION

Engine.....	10
[10.001] Engine and crankcase .....	10.1
[10.103] Crankshaft and flywheel.....	10.2
[10.106] Valve drive and gears .....	10.3
[10.206] Fuel filters .....	10.4
[10.250] Turbocharger and lines.....	10.5
[10.218] Fuel injection system.....	10.6
[10.254] Intake and exhaust manifolds and muffler .....	10.7
[10.414] Fan and drive .....	10.8
[10.400] Engine cooling system .....	10.9
[10.450] Engine air compressor .....	10.10
Transmission.....	21
[21.900] Hydraulic pump drive.....	21.1
Front axle system .....	25
[25.100] Powered front axle .....	25.1
[25.122] Axle suspension control.....	25.2
Rear axle system.....	27
[27.120] Planetary and final drives .....	27.1
Hydrostatic drive.....	29
[29.202] Hydrostatic transmission .....	29.1
Brakes and controls .....	33
[33.110] Parking brake or parking lock .....	33.1
[33.202] Hydraulic service brakes .....	33.2
Hydraulic systems.....	35
[35.000] Hydraulic systems.....	35.1

[35.105] Charge pump.....	35.2
[35.300] Reservoir, cooler, and filters.....	35.3
[35.310] Distributor and lines.....	35.4
[35.600] High flow hydraulics.....	35.5
[35.820] Hydraulic driven cooling fans.....	35.6
<b>Steering.....</b>	<b>41</b>
[41.216] Cylinders.....	41.1
[41.200] Hydraulic control components.....	41.2
[41.101] Steering control.....	41.3
<b>Tracks and track suspension.....</b>	<b>48</b>
[48.110] Front suspension.....	48.1
[48.130] Track frame and driving wheels.....	48.2
[48.100] Tracks.....	48.3
[48.138] Track rollers.....	48.4
<b>Cab climate control.....</b>	<b>50</b>
[50.200] Air conditioning.....	50.1
<b>Electrical systems.....</b>	<b>55</b>
[55.100] Harnesses and connectors.....	55.1
[55.000] Electrical system.....	55.2
[55.024] Transmission control system.....	55.3
[55.405] External lighting switches and relays.....	55.4
[55.513] Cab transmission controls.....	55.5
[55.514] Cab lighting.....	55.6
[55.051] Cab Heating, Ventilation, and Air-Conditioning (HVAC) controls.....	55.7
[55.518] Wiper and washer system.....	55.8
[55.036] Hydraulic system control.....	55.9
[55.820] Chopping and cutting control systems.....	55.10
<b>Attachments/Headers.....</b>	<b>58</b>

[58.130] Attachment/Header frame.....	58.1
<b>Product feeding .....</b>	<b>60</b>
[60.370] Basecutter.....	60.1
[60.340] Topper.....	60.2
[60.110] Feeder housing.....	60.3
[60.350] Crop divider.....	60.4
[60.380] Butt lifter roller.....	60.5
[60.360] Knock-down rollers.....	60.6
[60.390] Conveyor roller train.....	60.7
<b>Chopping.....</b>	<b>64</b>
[64.000] Chopping.....	64.1
[64.106] Drum.....	64.2
[64.130] Drum gearbox.....	64.3
[64.160] Crop processor.....	64.4
<b>Cleaning.....</b>	<b>74</b>
[74.200] Upper extractors.....	74.1
[74.130] Fan housing.....	74.2
[74.204] Lower extractors.....	74.3
<b>Crop storage / Unloading.....</b>	<b>80</b>
[80.420] Billet elevator.....	80.1



# INTRODUCTION



# Contents

---

## INTRODUCTION

Foreword - How to use and navigate through this manual .....	3
Foreword - Important notice regarding equipment servicing .....	8
Safety rules (*) .....	9
Safety rules - Ecology and the environment .....	10
Basic instructions - Shop and assembly .....	11
Torque - Minimum tightening torques for normal assembly .....	13
Torque - Standard torque data for hydraulics .....	18

(\*) See content for specific models

---

## Foreword - How to use and navigate through this manual

This manual has been produced by a new technical information system. This new system is designed to deliver technical information electronically through web delivery (eTIM), DVD, and paper manuals. A coding system called SAP has been developed to link the technical information to other Product Support functions, e.g., Warranty.

Technical information is written to support the maintenance and service of the functions or systems on a customer's machine. When a customer has a concern on their machine it is usually because a function or system on their machine is not working at all, is not working efficiently, or is not responding correctly to their commands. When you refer to the technical information in this manual to resolve that customer's concern, you will find all the information classified using the SAP coding, according to the functions or systems on that machine. Once you have located the technical information for that function or system, you will then find all the mechanical, electrical or hydraulic devices, components, assemblies, and sub assemblies for that function or system. You will also find all the types of information that have been written for that function or system: the technical data (specifications), the functional data (how it works), the diagnostic data (fault codes and troubleshooting), and the service data (remove, install adjust, etc.).

By integrating SAP coding into technical information, you will be able to search and retrieve just the right piece of technical information you need to resolve that customer's concern on his machine. This is made possible by attaching 3 categories to each piece of technical information during the authoring process.

The first category is the Location, the second category is the Information Type and the third category is the Product:

- LOCATION - the component or function on the machine, that the piece of technical information is going to describe (e.g., Fuel tank).
- INFORMATION TYPE - the piece of technical information that has been written for a particular component or function on the machine (e.g., Capacity would be a type of Technical Data describing the amount of fuel held by the fuel tank).
- PRODUCT - the model for which the piece of technical information is written.

Every piece of technical information will have those three categories attached to it. You will be able to use any combination of those categories to find the right piece of technical information you need to resolve that customer's concern on their machine.

That information could be:

- the procedure for how to remove the cylinder head
- a table of specifications for a hydraulic pump
- a fault code
- a troubleshooting table
- a special tool

## Manual content

This manual is divided into Sections. Each Section is then divided into Chapters. Contents pages are included at the beginning of the manual, then inside every Section and inside every Chapter. An alphabetical Index is included at the end of each Chapter. Page number references are included for every piece of technical information listed in the Chapter Contents or Chapter Index.

Each Chapter is divided into four Information types:

- Technical Data (specifications) for all the mechanical, electrical or hydraulic devices, components, assemblies or sub-assemblies.
- Functional Data (how it works) for all the mechanical, electrical or hydraulic devices, components, assemblies or sub-assemblies.
- Diagnostic Data (fault codes, electrical and hydraulic troubleshooting) for all the mechanical, electrical or hydraulic devices, components, assemblies or sub-assemblies.
- Service Data (remove disassemble, assemble, install) for all the mechanical, electrical or hydraulic devices, components, assemblies or sub-assemblies.

## Sections

Sections are grouped according to the main functions or a systems on the machine. Each Section is identified by a number (00, 35, 55, etc.). The Sections included in the manual will depend on the type and function of the machine that the manual is written for. Each Section has a Contents page listed in alphabetic/numeric order. This table illustrates which Sections could be included in a manual for a particular product.

SECTION	PRODUCT				
	Tractors				
	Vehicles with working arms: backhoes, excavators, skid steers, ....				
	Combines, forage harvesters, balers, ....				
	Seeding, planting, floating, spraying equipment, ....				
	Mounted equipment and tools, ....				
00 - Maintenance	X	X	X	X	X
05 - Machine completion and equipment	X	X	X	X	X
10 - Engine	X	X	X	X	
14 - Main gearbox and drive	X	X	X	X	
18 - Clutch	X	X	X		
21 - Transmission	X	X	X	X	
23 - Four wheel drive (4WD) system	X	X	X	X	
25 - Front axle system	X	X	X	X	
27 - Rear axle system	X	X	X	X	
29 - Hydrostatic drive	X	X	X	X	
31 - Power Take-Off (PTO)	X		X		
33 - Brakes and controls	X	X	X	X	
35 - Hydraulic systems	X	X	X	X	
36 - Pneumatic system	X	X	X	X	
37 - Hitches, drawbars and implement couplings	X		X	X	
39 - Frames and ballasting	X	X	X	X	X
41 - Steering	X	X	X	X	
44 - Wheels	X	X	X	X	
46 - Steering clutches					
48 - Tracks and track suspension	X	X	X		
50 - Cab climate control	X	X	X	X	
55 - Electrical systems	X	X	X	X	X
56 - Grape harvester shaking					
58 - Attachments/headers			X		
60 - Product feeding			X		

INTRODUCTION

61 - Metering system				X	
62 - Pressing - Bale formation			X		
63 - Chemical applicators				X	
64 - Chopping			X		
66 - Threshing			X		
68 - Tying/Wrapping/Twisting			X		
69 - Bale wagons					
70 - Ejection			X		
71 - Lubrication system	X	X	X	X	X
72 - Separation			X		
73 - Residue handling			X		
74 - Cleaning			X		
75 - Soil preparation/Finishing					
76 - Secondary cleaning / Destemmer					
77 - Seeding				X	
78 - Spraying				X	
79 - Planting				X	
80 - Crop storage / Unloading			X		
82 - Front loader and bucket	X	X			
83 - Telescopic single arm	X	X			
84 - Booms, dippers and buckets	X	X			
86 - Dozer blade and arm	X	X			
88 - Accessories	X	X	X	X	X
89 - Tools	X	X	X	X	X
90 - Platform, cab, bodywork and decals	X	X	X	X	

## Chapters

Each Chapter is identified by a number e.g. Engine - Engine and crankcase - 10.001. The first number is identical to the Section number i.e. Chapter 10.001 is inside Section 10, Engine. The second number is representative of the Chapter contained within the Section.

### CONTENTS

The Chapter Contents lists all the technical data (specifications), functional data (how it works), diagnostic data (fault codes and troubleshooting), and service data (remove, install, adjust, etc.), that have been written in that Chapter for that function or system on the machine.

### Contents

#### ENGINE

#### ENGINE - Engine and crankcase – 10.001

##### TECHNICAL DATA

ENGINE - Engine and crankcase - General specification (10.001 - D.40.A.10)	4
--	---

##### FUNCTIONAL DATA

ENGINE - Engine and crankcase - Dynamic description (10.001 - C.30.A.10)	6
--	---

##### SERVICE

ENGINE - Engine and crankcase - Remove (10.001 -F.10.A.10)	8
--	---

##### DIAGNOSTIC

ENGINE - Engine and crankcase - Troubleshooting (10.001 - G.40.A.10)	10
--	----

### INDEX

The Chapter Index lists in alphabetical order all the types of information (called information units) that have been written in that Chapter for that function or system on the machine.

### Index

#### ENGINE - 10

#### ENGINE

ENGINE - Engine and crankcase - Dynamic description (10.001 - C.30.A.10)	6
--	---

ENGINE - Engine and crankcase - General specification (10.001 - D.40.A.10)	4
--	---

ENGINE - Engine and crankcase - Remove (10.001 -F.10.A.10)	8
--	---

ENGINE - Engine and crankcase - Troubleshooting (10.001 - G.40.A.10)	10
--	----

## Information units and information search

Each chapter is composed of information units. Each information unit has the SAP code shown in parentheses. This indicates the function and type of information in that information unit. Each information unit has a page reference within that Chapter. The information units provide a quick and easy way to find just the right piece of technical information you are looking for.

Example information unit	Engine block cover - Front – Remove (10.102.AP.01 - F.10.A.10)					
Information Unit SAP code	10	102	AK	01	F	10.A.10
SAP code classification	Engine	Pan and covers	Engine block cover	Front	Service data	Remove

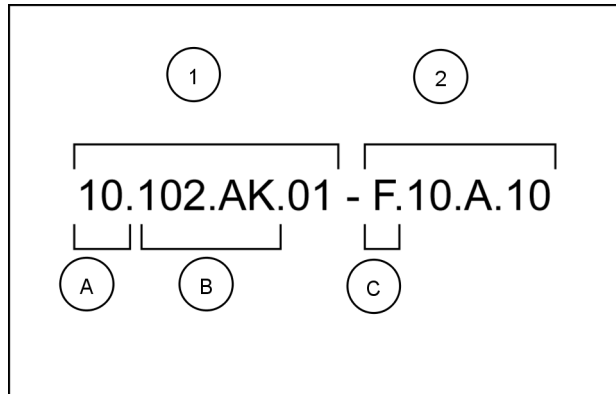

NHIL12GEN0070A 1

Navigate to the correct information unit you are searching for by identifying the function and information type from the SAP code.

- **(1)** Location and **(2)** Information type.
- **(A)** corresponds to the sections of the service manual.  
**(B)** corresponds to the chapters of the service manual. After **(B)** there may be some additional information. In this case it shows “.01”, which represents the “Front” block cover. These options may be front/rear, left/right, hydraulic/mechanical etc.  
**(C)** corresponds to the type of information listed in the chapter contents: Technical Data, Functional Data, Diagnostic, or Service.  
**(A)** and **(B)** are also shown in the page numbering on the page footer.  
 THE REST OF THE CODING IS NOT LISTED IN ALPHANUMERIC ORDER IN THIS MANUAL.
- You will find a table of contents at the beginning and end of each section and chapter.  
 You will find an alphabetical index at the end of each chapter.
- By referring to **(A)**, **(B)** and **(C)** of the coding, you can follow the contents or index (page numbers) and quickly find the information you are looking for.

## Page header and footer

The page header will contain the following references:

- Section and Chapter description

The page footer will contain the following references:

- Publication number for that Manual.
- Version reference for that publication.
- Publication date
- Section, chapter, and page reference e.g. 10.102 / 9

---

## **Foreword - Important notice regarding equipment servicing**

All repair and maintenance work listed in this manual must be carried out only by qualified dealership personnel, strictly complying with the instructions given, and using, whenever possible, the special tools.

Anyone who performs repair and maintenance operations without complying with the procedures provided herein shall be responsible for any subsequent damages.

The manufacturer and all the organizations of its distribution chain, including - without limitation - national, regional, or local dealers, reject any responsibility for damages caused by parts and/or components not approved by the manufacturer, including those used for the servicing or repair of the product manufactured or marketed by the manufacturer. In any case, no warranty is given or attributed on the product manufactured or marketed by the manufacturer in case of damages caused by parts and/or components not approved by the manufacturer.

The manufacturer reserves the right to make improvements in design and changes in specifications at any time without notice and without incurring any obligation to install them on units previously sold. Specifications, descriptions, and illustrative material herein are as accurate as known at time of publication but are subject to change without notice.

In case of questions, refer to your CASE IH Sales and Service Networks.

---

## Safety rules

8000	
8800	

### Personal safety





This is the safety alert symbol. It is used to alert you to potential personal injury hazards. Obey all safety messages that follow this symbol to avoid possible death or injury.

Throughout this manual you will find the signal words DANGER, WARNING, and CAUTION followed by special instructions. These precautions are intended for the personal safety of you and those working with you.

Read and understand all the safety messages in this manual before you operate or service the machine.

 DANGER indicates a hazardous situation that, if not avoided, will result in death or serious injury.

 WARNING indicates a hazardous situation that, if not avoided, could result in death or serious injury.

 CAUTION indicates a hazardous situation that, if not avoided, could result in minor or moderate injury.

### **FAILURE TO FOLLOW DANGER, WARNING, AND CAUTION MESSAGES COULD RESULT IN DEATH OR SERIOUS INJURY.**

#### Machine safety

**NOTICE:** Notice indicates a situation that, if not avoided, could result in machine or property damage.

Throughout this manual you will find the signal word Notice followed by special instructions to prevent machine or property damage. The word Notice is used to address practices not related to personal safety.

#### Information

**NOTE:** Note indicates additional information that clarifies steps, procedures, or other information in this manual.

Throughout this manual you will find the word Note followed by additional information about a step, procedure, or other information in the manual. The word Note is not intended to address personal safety or property damage.



---

## Safety rules - Ecology and the environment

Soil, air, and water quality is important for all industries and life in general. When legislation does not yet rule the treatment of some of the substances that advanced technology requires, sound judgment should govern the use and disposal of products of a chemical and petrochemical nature.

Familiarize yourself with the relative legislation applicable to your country, and make sure that you understand this legislation. Where no legislation exists, obtain information from suppliers of oils, filters, batteries, fuels, anti-freeze, cleaning agents, etc., with regard to the effect of these substances on man and nature and how to safely store, use, and dispose of these substances.

### Helpful hints

- Avoid the use of cans or other inappropriate pressurized fuel delivery systems to fill tanks. Such delivery systems may cause considerable spillage.
- In general, avoid skin contact with all fuels, oils, acids, solvents, etc. Most of these products contain substances that may be harmful to your health.
- Modern oils contain additives. Do not burn contaminated fuels and or waste oils in ordinary heating systems.
- Avoid spillage when you drain fluids such as used engine coolant mixtures, engine oil, hydraulic fluid, brake fluid, etc. Do not mix drained brake fluids or fuels with lubricants. Store all drained fluids safely until you can dispose of the fluids in a proper way that complies with all local legislation and available resources.
- Do not allow coolant mixtures to get into the soil. Collect and dispose of coolant mixtures properly.
- The air-conditioning system contains gases that should not be released into the atmosphere. Consult an air-conditioning specialist or use a special extractor to recharge the system properly.
- Repair any leaks or defects in the engine cooling system or hydraulic system immediately.
- Do not increase the pressure in a pressurized circuit as this may lead to a component failure.
- Protect hoses during welding. Penetrating weld splatter may burn a hole or weaken hoses, allowing the loss of oils, coolant, etc.

### Battery recycling

Batteries and electric accumulators contain several substances that can have a harmful effect on the environment if the batteries are not properly recycled after use. Improper disposal of batteries can contaminate the soil, groundwater, and waterways. CASE IH strongly recommends that you return all used batteries to a CASE IH dealer, who will dispose of the used batteries or recycle the used batteries properly. In some countries, this is a legal requirement.



### Mandatory battery recycling

**NOTE:** *The following requirements are mandatory in Brazil.*

Batteries are made of lead plates and a sulfuric acid solution. Because batteries contain heavy metals such as lead, CONAMA Resolution 401/2008 requires you to return all used batteries to the battery dealer when you replace any batteries. Do not dispose of batteries in your household garbage.

Points of sale are obliged to:

- Accept the return of your used batteries
- Store the returned batteries in a suitable location
- Send the returned batteries to the battery manufacturer for recycling

---

## Basic instructions - Shop and assembly

### Shimming

For each adjustment operation, select adjusting shims and measure the adjusting shims individually using a micrometer, then add up the recorded values. Do not rely on measuring the entire shimming set, which may be incorrect, or the rated value shown on each shim.

### Rotating shaft seals

For correct rotating shaft seal installation, proceed as follows:

1. Before assembly, allow the seal to soak in the oil it will be sealing for at least thirty minutes.
2. Thoroughly clean the shaft and check that the working surface on the shaft is not damaged.
3. Position the sealing lip facing the fluid.

**NOTE:** *With hydrodynamic lips, take into consideration the shaft rotation direction and position the grooves so that they will move the fluid towards the inner side of the seal.*

4. Coat the sealing lip with a thin layer of lubricant (use oil rather than grease). Fill the gap between the sealing lip and the dust lip on double lip seals with grease.
5. Insert the seal in its seat and press down using a flat punch or seal installation tool. Do not tap the seal with a hammer or mallet.
6. While you insert the seal, check that the seal is perpendicular to the seat. When the seal settles, make sure that the seal makes contact with the thrust element, if required.
7. To prevent damage to the seal lip on the shaft, position a protective guard during installation operations.

### O-ring seals

Lubricate the O-ring seals before you insert them in the seats. This will prevent the O-ring seals from overturning and twisting, which would jeopardize sealing efficiency.

### Sealing compounds

Apply a sealing compound on the mating surfaces when specified by the procedure. Before you apply the sealing compound, prepare the surfaces as directed by the product container.

### Spare parts

Only use CNH Original Parts or CASE IH Original Parts.

Only genuine spare parts guarantee the same quality, duration, and safety as original parts, as they are the same parts that are assembled during standard production. Only CNH Original Parts or CASE IH Original Parts can offer this guarantee.

When ordering spare parts, always provide the following information:

- Machine model (commercial name) and Product Identification Number (PIN)
- Part number of the ordered part, which can be found in the parts catalog

---

## Protecting the electronic and/or electrical systems during charging and welding

To avoid damage to the electronic and/or electrical systems, always observe the following practices:

1. Never make or break any of the charging circuit connections when the engine is running, including the battery connections.
2. Never short any of the charging components to ground.
3. Always disconnect the ground cable from the battery before arc welding on the machine or on any machine attachment.
  - Position the welder ground clamp as close to the welding area as possible.
  - If you weld in close proximity to a computer module, then you should remove the module from the machine.
  - Never allow welding cables to lie on, near, or across any electrical wiring or electronic component while you weld.
4. Always disconnect the negative cable from the battery when charging the battery in the machine with a battery charger.

**NOTICE:** *If you must weld on the unit, you must disconnect the battery ground cable from the machine battery. The electronic monitoring system and charging system will be damaged if this is not done.*

5. Remove the battery ground cable. Reconnect the cable when you complete welding.

### **WARNING**

**Battery acid causes burns. Batteries contain sulfuric acid.**

**Avoid contact with skin, eyes or clothing. Antidote (external): Flush with water. Antidote (eyes): flush with water for 15 minutes and seek medical attention immediately. Antidote (internal): Drink large quantities of water or milk. Do not induce vomiting. Seek medical attention immediately. Failure to comply could result in death or serious injury.**

W0111A

## Special tools

The special tools that CASE IH suggests and illustrate in this manual have been specifically researched and designed for use with CASE IH machines. The special tools are essential for reliable repair operations. The special tools are accurately built and rigorously tested to offer efficient and long-lasting operation.

By using these tools, repair personnel will benefit from:

- Operating in optimal technical conditions
- Obtaining the best results
- Saving time and effort
- Working in safe conditions

## Torque - Minimum tightening torques for normal assembly

### METRIC NON-FLANGED HARDWARE

NOM. SIZE	CLASS 8.8 BOLT and CLASS 8 NUT		CLASS 10.9 BOLT and CLASS 10 NUT		LOCKNUT CL.8 W/CL8.8 BOLT	LOCKNUT CL.10 W/CL10.9 BOLT
	UNPLATED	PLATED W/ZnCr	UNPLATED	PLATED W/ZnCr		
M4	2.2 N·m (19 lb in)	2.9 N·m (26 lb in)	3.2 N·m (28 lb in)	4.2 N·m (37 lb in)	2 N·m (18 lb in)	2.9 N·m (26 lb in)
M5	4.5 N·m (40 lb in)	5.9 N·m (52 lb in)	6.4 N·m (57 lb in)	8.5 N·m (75 lb in)	4 N·m (36 lb in)	5.8 N·m (51 lb in)
M6	7.5 N·m (66 lb in)	10 N·m (89 lb in)	11 N·m (96 lb in)	15 N·m (128 lb in)	6.8 N·m (60 lb in)	10 N·m (89 lb in)
M8	18 N·m (163 lb in)	25 N·m (217 lb in)	26 N·m (234 lb in)	35 N·m (311 lb in)	17 N·m (151 lb in)	24 N·m (212 lb in)
M10	37 N·m (27 lb ft)	49 N·m (36 lb ft)	52 N·m (38 lb ft)	70 N·m (51 lb ft)	33 N·m (25 lb ft)	48 N·m (35 lb ft)
M12	64 N·m (47 lb ft)	85 N·m (63 lb ft)	91 N·m (67 lb ft)	121 N·m (90 lb ft)	58 N·m (43 lb ft)	83 N·m (61 lb ft)
M16	158 N·m (116 lb ft)	210 N·m (155 lb ft)	225 N·m (166 lb ft)	301 N·m (222 lb ft)	143 N·m (106 lb ft)	205 N·m (151 lb ft)
M20	319 N·m (235 lb ft)	425 N·m (313 lb ft)	440 N·m (325 lb ft)	587 N·m (433 lb ft)	290 N·m (214 lb ft)	400 N·m (295 lb ft)
M24	551 N·m (410 lb ft)	735 N·m (500 lb ft)	762 N·m (560 lb ft)	1016 N·m (750 lb ft)	501 N·m (370 lb ft)	693 N·m (510 lb ft)

**NOTE:** M4 through M8 hardware torque specifications are shown in pound-inches. M10 through M24 hardware torque specifications are shown in pound-feet.

**METRIC FLANGED HARDWARE**

NOM. SIZE	CLASS 8.8 BOLT and CLASS 8 NUT		CLASS 10.9 BOLT and CLASS 10 NUT		LOCKNUT CL.8 W/CL8.8 BOLT	LOCKNUT CL.10 W/CL10.9 BOLT
	UNPLATED	PLATED W/ZnCr	UNPLATED	PLATED W/ZnCr		
M4	2.4 N·m (21 lb in)	3.2 N·m (28 lb in)	3.5 N·m (31 lb in)	4.6 N·m (41 lb in)	2.2 N·m (19 lb in)	3.1 N·m (27 lb in)
M5	4.9 N·m (43 lb in)	6.5 N·m (58 lb in)	7.0 N·m (62 lb in)	9.4 N·m (83 lb in)	4.4 N·m (39 lb in)	6.4 N·m (57 lb in)
M6	8.3 N·m (73 lb in)	11 N·m (96 lb in)	12 N·m (105 lb in)	16 N·m (141 lb in)	7.5 N·m (66 lb in)	11 N·m (96 lb in)
M8	20 N·m (179 lb in)	27 N·m (240 lb in)	29 N·m (257 lb in)	39 N·m (343 lb in)	18 N·m (163 lb in)	27 N·m (240 lb in)
M10	40 N·m (30 lb ft)	54 N·m (40 lb ft)	57 N·m (42 lb ft)	77 N·m (56 lb ft)	37 N·m (27 lb ft)	53 N·m (39 lb ft)
M12	70 N·m (52 lb ft)	93 N·m (69 lb ft)	100 N·m (74 lb ft)	134 N·m (98 lb ft)	63 N·m (47 lb ft)	91 N·m (67 lb ft)
M16	174 N·m (128 lb ft)	231 N·m (171 lb ft)	248 N·m (183 lb ft)	331 N·m (244 lb ft)	158 N·m (116 lb ft)	226 N·m (167 lb ft)
M20	350 N·m (259 lb ft)	467 N·m (345 lb ft)	484 N·m (357 lb ft)	645 N·m (476 lb ft)	318 N·m (235 lb ft)	440 N·m (325 lb ft)
M24	607 N·m (447 lb ft)	809 N·m (597 lb ft)	838 N·m (618 lb ft)	1118 N·m (824 lb ft)	552 N·m (407 lb ft)	

**IDENTIFICATION**

**Metric Hex head and carriage bolts, classes 5.6 and up**

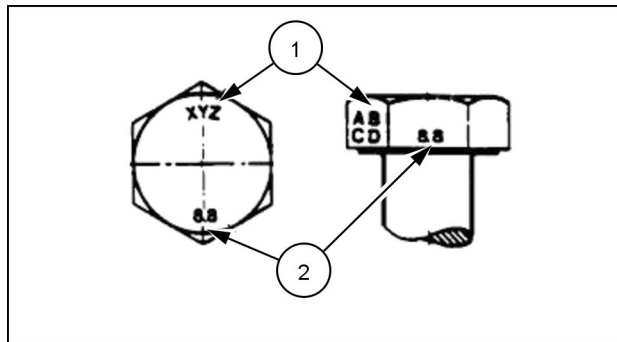

20083680 1

1. Manufacturer's Identification
2. Property Class

**Metric Hex nuts and locknuts, classes 05 and up**

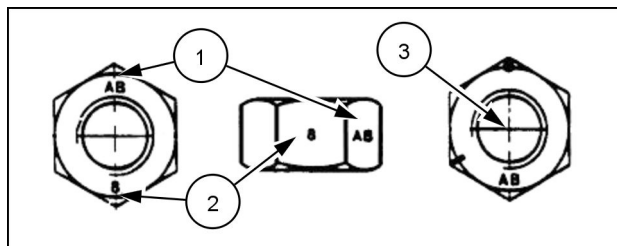

20083681 2

1. Manufacturer's Identification
2. Property Class
3. Clock Marking of Property Class and Manufacturer's Identification (Optional), i.e. marks **60** ° apart indicate Class 10 properties, and marks **120** ° apart indicate Class 8.

**INCH NON-FLANGED HARDWARE**

NOMINAL SIZE	SAE GRADE 5 BOLT and NUT		SAE GRADE 8 BOLT and NUT		LOCKNUT GrB W/ Gr5 BOLT	LOCKNUT GrC W/ Gr8 BOLT
	UN-PLATED or PLATED SILVER	PLATED W/ZnCr GOLD	UN-PLATED or PLATED SILVER	PLATED W/ZnCr GOLD		
1/4	8 N·m (71 lb in)	11 N·m (97 lb in)	12 N·m (106 lb in)	16 N·m (142 lb in)	8.5 N·m (75 lb in)	12.2 N·m (109 lb in)
5/16	17 N·m (150 lb in)	23 N·m (204 lb in)	24 N·m (212 lb in)	32 N·m (283 lb in)	17.5 N·m (155 lb in)	25 N·m (220 lb in)
3/8	30 N·m (22 lb ft)	40 N·m (30 lb ft)	43 N·m (31 lb ft)	57 N·m (42 lb ft)	31 N·m (23 lb ft)	44 N·m (33 lb ft)
7/16	48 N·m (36 lb ft)	65 N·m (48 lb ft)	68 N·m (50 lb ft)	91 N·m (67 lb ft)	50 N·m (37 lb ft)	71 N·m (53 lb ft)
1/2	74 N·m (54 lb ft)	98 N·m (73 lb ft)	104 N·m (77 lb ft)	139 N·m (103 lb ft)	76 N·m (56 lb ft)	108 N·m (80 lb ft)
9/16	107 N·m (79 lb ft)	142 N·m (105 lb ft)	150 N·m (111 lb ft)	201 N·m (148 lb ft)	111 N·m (82 lb ft)	156 N·m (115 lb ft)
5/8	147 N·m (108 lb ft)	196 N·m (145 lb ft)	208 N·m (153 lb ft)	277 N·m (204 lb ft)	153 N·m (113 lb ft)	215 N·m (159 lb ft)
3/4	261 N·m (193 lb ft)	348 N·m (257 lb ft)	369 N·m (272 lb ft)	491 N·m (362 lb ft)	271 N·m (200 lb ft)	383 N·m (282 lb ft)
7/8	420 N·m (310 lb ft)	561 N·m (413 lb ft)	594 N·m (438 lb ft)	791 N·m (584 lb ft)	437 N·m (323 lb ft)	617 N·m (455 lb ft)
1	630 N·m (465 lb ft)	841 N·m (620 lb ft)	890 N·m (656 lb ft)	1187 N·m (875 lb ft)	654 N·m (483 lb ft)	924 N·m (681 lb ft)

**NOTE:** For Imperial Units, *1/4 in* and *5/16 in* hardware torque specifications are shown in pound-inches. *3/8 in* through *1 in* hardware torque specifications are shown in pound-feet.

**INCH FLANGED HARDWARE**

NOM- INAL SIZE	SAE GRADE 5 BOLT and NUT		SAE GRADE 8 BOLT and NUT		LOCKNUT GrF W/ Gr5 BOLT	LOCKNUT GrG W/ Gr8 BOLT
	UNPLATED or PLATED SILVER	PLATED W/ZnCr GOLD	UNPLATED or PLATED SILVER	PLATED W/ZnCr GOLD		
1/4	9 N·m (80 lb in)	12 N·m (106 lb in)	13 N·m (115 lb in)	17 N·m (150 lb in)	8 N·m (71 lb in)	12 N·m (106 lb in)
5/16	19 N·m (168 lb in)	25 N·m (221 lb in)	26 N·m (230 lb in)	35 N·m (310 lb in)	17 N·m (150 lb in)	24 N·m (212 lb in)
3/8	33 N·m (25 lb ft)	44 N·m (33 lb ft)	47 N·m (35 lb ft)	63 N·m (46 lb ft)	30 N·m (22 lb ft)	43 N·m (32 lb ft)
7/16	53 N·m (39 lb ft)	71 N·m (52 lb ft)	75 N·m (55 lb ft)	100 N·m (74 lb ft)	48 N·m (35 lb ft)	68 N·m (50 lb ft)
1/2	81 N·m (60 lb ft)	108 N·m (80 lb ft)	115 N·m (85 lb ft)	153 N·m (113 lb ft)	74 N·m (55 lb ft)	104 N·m (77 lb ft)
9/16	117 N·m (86 lb ft)	156 N·m (115 lb ft)	165 N·m (122 lb ft)	221 N·m (163 lb ft)	106 N·m (78 lb ft)	157 N·m (116 lb ft)
5/8	162 N·m (119 lb ft)	216 N·m (159 lb ft)	228 N·m (168 lb ft)	304 N·m (225 lb ft)	147 N·m (108 lb ft)	207 N·m (153 lb ft)
3/4	287 N·m (212 lb ft)	383 N·m (282 lb ft)	405 N·m (299 lb ft)	541 N·m (399 lb ft)	261 N·m (193 lb ft)	369 N·m (272 lb ft)
7/8	462 N·m (341 lb ft)	617 N·m (455 lb ft)	653 N·m (482 lb ft)	871 N·m (642 lb ft)	421 N·m (311 lb ft)	594 N·m (438 lb ft)
1	693 N·m (512 lb ft)	925 N·m (682 lb ft)	979 N·m (722 lb ft)	1305 N·m (963 lb ft)	631 N·m (465 lb ft)	890 N·m (656 lb ft)

**IDENTIFICATION**

**Inch Bolts and free-spinning nuts**

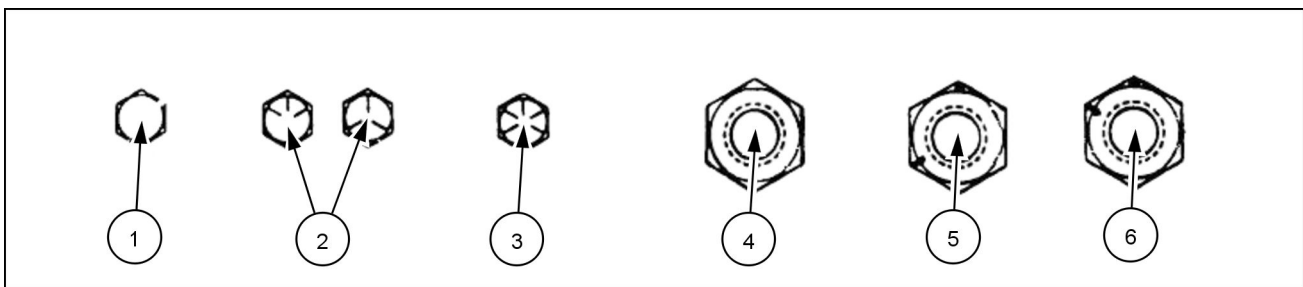

20083682 3

**Grade Marking Examples**

SAE Grade Identification			
1	Grade 2 - No Marks	4	Grade 2 Nut - No Marks
2	Grade 5 - Three Marks	5	Grade 5 Nut - Marks 120 ° Apart
3	Grade 8 - Five Marks	6	Grade 8 Nut - Marks 60 ° Apart

Thank you so much for reading.  
Please click the “Buy Now!”  
button below to download the  
complete manual.



After you pay.

You can download the most  
perfect and complete manual in  
the world immediately.

Our support email:

[ebooklibonline@outlook.com](mailto:ebooklibonline@outlook.com)