

# SERVICE MANUAL

## NEF Tier 4A (interim) and Stage IIIB Engine

*See the following page for engine model numbers*



## SERVICE MANUAL

**F4DFE413A\*A, F4DFE413B\*A, F4DFE413C\*A, F4DFE413D\*A, F4DFE413E\*A,  
F4DFE6132\*A, F4DFE613A\*A, F4DFE613B\*A, F4DFE613C\*A, F4DFE613D\*A,  
F4DFE613E\*A, F4DFE613F\*A, F4DFE613G\*A, F4DFE613H\*A, F4DFE613J\*A,  
F4DFE613K\*A, F4DFE613L\*A, F4HFE413A\*A005, F4HFE413C\*A,  
F4HFE413D\*A008, F4HFE413H\*A, F4HFE413J\*A, F4HFE413L\*A007,  
F4HFE413M\*A005, F4HFE413P\*A001, F4HFE6131\*A, F4HFE6132\*A004,  
F4HFE6138\*A002, F4HFE613F\*A002, F4HFE613G\*A, F4HFE613H\*A,  
F4HFE613J\*A007, F4HFE613J\*A, F4HFE613K\*A, F4HFE613P\*A,  
F4HFE613R\*A, F4HFE613T\*A004, F4HFE613T\*A005, F4HFE613U\*A005,  
F4HFE613U\*A006, F4HFE613V\*A003, F4HFE613X\*A, F4HFE613Y\*A,  
F4HFE613Z\*A005, F4HFE613Z\*A006, F4HFE614E\*A001**

# Contents

---

## INTRODUCTION

Engine.....	10
[10.001] Engine and crankcase .....	10.1
[10.102] Pan and covers .....	10.2
[10.106] Valve drive and gears .....	10.3
[10.101] Cylinder heads .....	10.4
[10.105] Connecting rods and pistons.....	10.5
[10.103] Crankshaft and flywheel.....	10.6
[10.110] Balancer and damper .....	10.7
[10.114] Pump drives .....	10.8
[10.210] Lift pump and lines .....	10.9
[10.206] Fuel filters .....	10.10
[10.218] Fuel injection system.....	10.11
[10.250] Turbocharger and lines.....	10.12
[10.254] Intake and exhaust manifolds and muffler .....	10.13
[10.500] Selective Catalytic Reduction (SCR) exhaust treatment .....	10.14
[10.400] Engine cooling system .....	10.15
[10.414] Fan and drive .....	10.16
[10.304] Engine lubrication system.....	10.17
[10.408] Oil cooler and lines.....	10.18
Electrical systems.....	55
[55.015] Engine control system.....	55.1
[55.201] Engine starting system.....	55.2
[55.301] Alternator.....	55.3
[55.202] Cold start aid .....	55.4
[55.010] Fuel injection system.....	55.5
[55.014] Engine intake and exhaust system.....	55.6

[55.988] Selective Catalytic Reduction (SCR) electrical system .....	55.7
[55.012] Engine cooling system .....	55.8
[55.013] Engine oil system .....	55.9



## INTRODUCTION

# Contents

---

## INTRODUCTION

Foreword .....	3
Safety rules .....	5
Torque .....	6
Basic instructions - Important notice regarding equipment servicing .....	9
Torque - Minimum tightening torques for normal assembly .....	10
Basic instructions - Shop and Assembly .....	15

## Safety rules

### Personal safety





This is the safety alert symbol. It is used to alert you to potential personal injury hazards. Obey all safety messages that follow this symbol to avoid possible death or injury.

Throughout this manual and on machine decals, you will find the signal words DANGER, WARNING, and CAUTION followed by special instructions. These precautions are intended for the personal safety of you and those working with you.

Read and understand all the safety messages in this manual before you operate or service the machine.

 DANGER indicates a hazardous situation which, if not avoided, will result in death or serious injury. The color associated with DANGER is RED.

 WARNING indicates a hazardous situation which, if not avoided, could result in death or serious injury. The color associated with WARNING is ORANGE.

 CAUTION, used with the safety alert symbol, indicates a hazardous situation which, if not avoided, could result in minor or moderate injury. The color associated with CAUTION is YELLOW.

### **FAILURE TO FOLLOW DANGER, WARNING, AND CAUTION MESSAGES COULD RESULT IN DEATH OR SERIOUS INJURY.**

### Machine safety

**NOTICE:** Notice indicates a situation which, if not avoided, could result in machine or property damage. The color associated with Notice is BLUE.

Throughout this manual you will find the signal word Notice followed by special instructions to prevent machine or property damage. The word Notice is used to address practices not related to personal safety.

### Information

**NOTE:** Note indicates additional information which clarifies steps, procedures, or other information in this manual.

Throughout this manual you will find the word Note followed by additional information about a step, procedure, or other information in the manual. The word Note is not intended to address personal safety or property damage.

## Torque

Component	Size	Specification
Cylinder head and components		
Plug	1/4"	10 - 14 Nm (7.4 - 10.3 lb ft)
	1/2"	20 - 28 Nm (14.8 - 20.7 lb ft)
	3/4"	31 - 41 Nm (22.9 - 30.2 lb ft)
Grid heater	M6 Nut	6 - 10 Nm (4.4 - 7.4 lb ft)
Intake manifold	M8 Screw	20 - 28 Nm (14.8 - 20.7 lb ft)
Engine lifting bracket		
Rear	M12	65 - 89 Nm (47.9 - 65.6 lb ft)
Front	M8	20 - 28 Nm (14.8 - 20.7 lb ft)
Cylinder head	<b>M12x1.75x130 mm</b>	
First phase		30 - 40 Nm (22.1 - 29.5 lb ft)
Second phase		85 - 95 °
Third phase		85 - 95 °
Cylinder head	<b>M12x1.75x150 mm</b>	
First phase		50 - 60 Nm (36.9 - 44.3 lb ft)
Second phase		85 - 95 °
Third phase		85 - 95 °
Rocker bracket		31 - 41 Nm (22.9 - 30.2 lb ft)
Rocker arm jam nuts		20 - 28 Nm (14.8 - 20.7 lb ft)
Exhaust manifold		48 - 58 Nm (35.4 - 42.8 lb ft)
Valve cover	M8 Nut	20 - 28 Nm (14.8 - 20.7 lb ft)
Turbocharger		
6 Cylinder	M8 Screw	6 - 8 Nm (4.4 - 5.9 lb ft)
	M8 Nut	37 - 49 Nm (27.3 - 36.1 lb ft)
4 Cylinder	M8 Screw	6 - 8 Nm (4.4 - 5.9 lb ft)
	M8 Nut	20 - 28 Nm (14.8 - 20.7 lb ft)
Front case		
Front cover	M8 Screw	20 - 28 Nm (14.8 - 20.7 lb ft)
Rear case		
Gear case	M12 Screw	65 - 89 Nm (47.9 - 65.6 lb ft)
	M10 Screw	42 - 52 Nm (31.0 - 38.4 lb ft)
	M8 Screw	20 - 28 Nm (14.8 - 20.7 lb ft)
Flywheel housing	M10	75 - 95 Nm (55.3 - 70.1 lb ft)
	M12	44 - 54 Nm (32.5 - 39.8 lb ft)
Cylinder block and crankshaft components		
Camshaft retaining plate	M8 Screw	20 - 28 Nm (14.8 - 20.7 lb ft)
Camshaft gear	M8 Screw	32 - 40 Nm (23.6 - 29.5 lb ft)
Crankcase plate	M10 Screw	38 - 48 Nm (28.0 - 35.4 lb ft)
Vibration damper and adapter		
First phase		45 - 55 Nm (33.2 - 40.6 lb ft)
Second phase		90 °
Drive pulley	M10	70.0 - 75.0 N·m (51.6 - 55.3 lb ft)
Engine flywheel		
First phase		26 - 34 Nm (19.2 - 25.1 lb ft)
Second phase		55 - 65 °
Main caps		
First phase		44 - 56 Nm (32.5 - 41.3 lb ft)
Second phase		74 - 86 Nm (54.6 - 63.4 lb ft)
Third phase		85 - 95 °
Connecting rod caps		
First phase		45.0 - 55.0 N·m (33.2 - 40.6 lb ft)
Second phase		55 - 65 °
Lubrication system and components		



INTRODUCTION

Component	Size	Specification
<b>Oil pump</b>		
First phase	M8	7 - 9 Nm (5.2 - 6.6 lb ft)
Second phase	M8	20 - 28 Nm (14.8 - 20.7 lb ft)
Oil pressure relief valve	M22	72 - 88 Nm (53.1 - 64.9 lb ft)
Oil cooler and oil filter base	M8 Screw	20 - 28 Nm (14.8 - 20.7 lb ft)
Oil Filter		Contact + ¾ Turn
Connection on filter base for turbo oil supply	1 ⅛"	20 - 28 Nm (14.8 - 20.7 lb ft)
Turbo lubrication pipe	M12 Nut	8 - 12 Nm (5.9 - 8.9 lb ft)
Turbo lubrication pipe adapter	M12	30 - 40 Nm (22.1 - 29.5 lb ft)
Oil pan		20 - 28 Nm (14.8 - 20.7 lb ft)
Piston spray nozzles	M8	12 - 18 Nm (8.9 - 13.3 lb ft)
<b>Electrical components</b>		
Camshaft sensor	M6 Studs	6 - 10 Nm (4.4 - 7.4 lb ft)
	M6 Nut	8 - 12 Nm (5.9 - 8.9 lb ft)
	M6 Screw	6 - 10 Nm (4.4 - 7.4 lb ft)
Wiring bulkhead	M6 Screw	8 - 12 Nm (5.9 - 8.9 lb ft)
Support bracket for injector wiring	M8 Screw	20 - 28 Nm (14.8 - 20.7 lb ft)
Injector wiring		1.25 - 1.75 Nm (0.92 - 1.29 lb ft)
ECU cooling plate	M6 Screw	8 - 12 Nm (5.9 - 8.9 lb ft)
	M8 Screw	20 - 28 Nm (14.8 - 20.7 lb ft)
Fuel outlet	M12	10 - 14 Nm (7.4 - 10.3 lb ft)
Fuel inlet	M12	10 - 14 Nm (7.4 - 10.3 lb ft)
Crankshaft speed sensor	M6 Screw	6 - 10 Nm (4.4 - 7.4 lb ft)
Coolant temperature sensor	M14 Screw	17 - 23 Nm (12.5 - 17.0 lb ft)
Oil pressure / Temperature sensor	M5 Screw	5 - 7 Nm (3.7 - 5.2 lb ft)
Fuel pressure sensor		30 - 40 Nm (22.1 - 29.5 lb ft)
Fuel temperature sensor	M14	17 - 23 Nm (12.5 - 17.0 lb ft)
Air pressure / Temperature sensor		5 - 7 Nm (3.7 - 5.2 lb ft)
Engine oil level sensor	M12	10 - 14 Nm (7.4 - 10.3 lb ft)
Alternator support bracket	M10 Screw	37 - 49 Nm (27.3 - 36.1 lb ft)
Alternator tension bracket	M10 Screw	37 - 49 Nm (27.3 - 36.1 lb ft)
Starter		37 - 49 Nm (27.3 - 36.1 lb ft)
<b>Fuel system and components</b>		
Feed pump	M8 Studs	10 - 14 Nm (7.4 - 10.3 lb ft)
High pressure pump gear	M18 Nut	100 - 110 Nm (73.8 - 81.1 lb ft)
Fuel pump	M8 Nut	20 - 28 Nm (14.8 - 20.7 lb ft)
<b>Injector</b>		
First phase	M6x1x35	3.5 N·m (31 lb in)
Second phase	M6x1x35	25 °
Third phase	M6x1x35	25 °
Fourth phase	M6x1x35	25 °
Injector feed connector		45 - 55 Nm (33.2 - 40.6 lb ft)
Common rail	M8 Screw	20 - 28 Nm (14.8 - 20.7 lb ft)
High pressure fuel line	M14 Fitting	18 - 22 Nm (13.3 - 16.2 lb ft)
High pressure pipe connector	M8 Screw	20 - 28 Nm (14.8 - 20.7 lb ft)
Fuel filter bracket	M12 Screw	71 - 85 Nm (52.4 - 62.7 lb ft)
Fuel filter holder	M8 Screw	20 - 28 Nm (14.8 - 20.7 lb ft)
Fuel filter		Contact + ¾ Turn
<b>Cooling system and components</b>		

INTRODUCTION

<b>Component</b>	<b>Size</b>	<b>Specification</b>
Engine coolant inlet	M10 Screw	<b>37 - 49 Nm (27.3 - 36.1 lb ft)</b>
Fitting on coolant inlet	<b>90 °</b> Elbow	<b>20 - 28 Nm (14.8 - 20.7 lb ft)</b>
Compressor cooling pipe		<b>20 - 24 Nm (14.8 - 17.7 lb ft)</b>
Engine coolant drain collector	M6 Screw	<b>8 - 12 Nm (5.9 - 8.9 lb ft)</b>
Water pump	M8 Screw	<b>20 - 28 Nm (14.8 - 20.7 lb ft)</b>
Belt tensioner	M10	<b>37 - 49 Nm (27.3 - 36.1 lb ft)</b>
Idler pulleys	M10	<b>37 - 49 Nm (27.3 - 36.1 lb ft)</b>

---

## **Basic instructions - Important notice regarding equipment servicing**

All repair and maintenance work listed in this manual must be carried out only by qualified dealership personnel, strictly complying with the instructions given, and using, whenever possible, the special tools.

Anyone who performs repair and maintenance operations without complying with the procedures provided herein shall be responsible for any subsequent damages.

The manufacturer and all the organizations of its distribution chain, including - without limitation - national, regional, or local dealers, reject any responsibility for damages caused by parts and/or components not approved by the manufacturer, including those used for the servicing or repair of the product manufactured or marketed by the manufacturer. In any case, no warranty is given or attributed on the product manufactured or marketed by the manufacturer in case of damages caused by parts and/or components not approved by the manufacturer.

The information in this manual is up-to-date at the date of the publication. It is the policy of the manufacturer for continuous improvement. Some information could not be updated due to modifications of a technical or commercial type, or changes to the laws and regulations of different countries.

In case of questions, refer to your CNH Sales and Service Networks.

## Torque - Minimum tightening torques for normal assembly

### METRIC NON-FLANGED HARDWARE

NOM. SIZE	CLASS 8.8 BOLT and CLASS 8 NUT		CLASS 10.9 BOLT and CLASS 10 NUT		LOCKNUT CL.8 W/CL8.8 BOLT	LOCKNUT CL.10 W/CL10.9 BOLT
	UNPLATED	PLATED W/ZnCr	UNPLATED	PLATED W/ZnCr		
M4	2.2 N·m (19 lb in)	2.9 N·m (26 lb in)	3.2 N·m (28 lb in)	4.2 N·m (37 lb in)	2 N·m (18 lb in)	2.9 N·m (26 lb in)
M5	4.5 N·m (40 lb in)	5.9 N·m (52 lb in)	6.4 N·m (57 lb in)	8.5 N·m (75 lb in)	4 N·m (36 lb in)	5.8 N·m (51 lb in)
M6	7.5 N·m (66 lb in)	10 N·m (89 lb in)	11 N·m (96 lb in)	15 N·m (128 lb in)	6.8 N·m (60 lb in)	10 N·m (89 lb in)
M8	18 N·m (163 lb in)	25 N·m (217 lb in)	26 N·m (234 lb in)	35 N·m (311 lb in)	17 N·m (151 lb in)	24 N·m (212 lb in)
M10	37 N·m (27 lb ft)	49 N·m (36 lb ft)	52 N·m (38 lb ft)	70 N·m (51 lb ft)	33 N·m (25 lb ft)	48 N·m (35 lb ft)
M12	64 N·m (47 lb ft)	85 N·m (63 lb ft)	91 N·m (67 lb ft)	121 N·m (90 lb ft)	58 N·m (43 lb ft)	83 N·m (61 lb ft)
M16	158 N·m (116 lb ft)	210 N·m (155 lb ft)	225 N·m (166 lb ft)	301 N·m (222 lb ft)	143 N·m (106 lb ft)	205 N·m (151 lb ft)
M20	319 N·m (235 lb ft)	425 N·m (313 lb ft)	440 N·m (325 lb ft)	587 N·m (433 lb ft)	290 N·m (214 lb ft)	400 N·m (295 lb ft)
M24	551 N·m (410 lb ft)	735 N·m (500 lb ft)	762 N·m (560 lb ft)	1016 N·m (750 lb ft)	501 N·m (370 lb ft)	693 N·m (510 lb ft)

**NOTE:** M4 through M8 hardware torque specifications are shown in pound-inches. M10 through M24 hardware torque specifications are shown in pound-feet.

**METRIC FLANGED HARDWARE**

NOM. SIZE	CLASS 8.8 BOLT and CLASS 8 NUT		CLASS 10.9 BOLT and CLASS 10 NUT		LOCKNUT CL.8 W/CL8.8 BOLT	LOCKNUT CL.10 W/CL10.9 BOLT
	UNPLATED	PLATED W/ZnCr	UNPLATED	PLATED W/ZnCr		
M4	2.4 N·m (21 lb in)	3.2 N·m (28 lb in)	3.5 N·m (31 lb in)	4.6 N·m (41 lb in)	2.2 N·m (19 lb in)	3.1 N·m (27 lb in)
M5	4.9 N·m (43 lb in)	6.5 N·m (58 lb in)	7.0 N·m (62 lb in)	9.4 N·m (83 lb in)	4.4 N·m (39 lb in)	6.4 N·m (57 lb in)
M6	8.3 N·m (73 lb in)	11 N·m (96 lb in)	12 N·m (105 lb in)	16 N·m (141 lb in)	7.5 N·m (66 lb in)	11 N·m (96 lb in)
M8	20 N·m (179 lb in)	27 N·m (240 lb in)	29 N·m (257 lb in)	39 N·m (343 lb in)	18 N·m (163 lb in)	27 N·m (240 lb in)
M10	40 N·m (30 lb ft)	54 N·m (40 lb ft)	57 N·m (42 lb ft)	77 N·m (56 lb ft)	37 N·m (27 lb ft)	53 N·m (39 lb ft)
M12	70 N·m (52 lb ft)	93 N·m (69 lb ft)	100 N·m (74 lb ft)	134 N·m (98 lb ft)	63 N·m (47 lb ft)	91 N·m (67 lb ft)
M16	174 N·m (128 lb ft)	231 N·m (171 lb ft)	248 N·m (183 lb ft)	331 N·m (244 lb ft)	158 N·m (116 lb ft)	226 N·m (167 lb ft)
M20	350 N·m (259 lb ft)	467 N·m (345 lb ft)	484 N·m (357 lb ft)	645 N·m (476 lb ft)	318 N·m (235 lb ft)	440 N·m (325 lb ft)
M24	607 N·m (447 lb ft)	809 N·m (597 lb ft)	838 N·m (618 lb ft)	1118 N·m (824 lb ft)	552 N·m (407 lb ft)	

**IDENTIFICATION**

**Metric Hex head and carriage bolts, classes 5.6 and up**

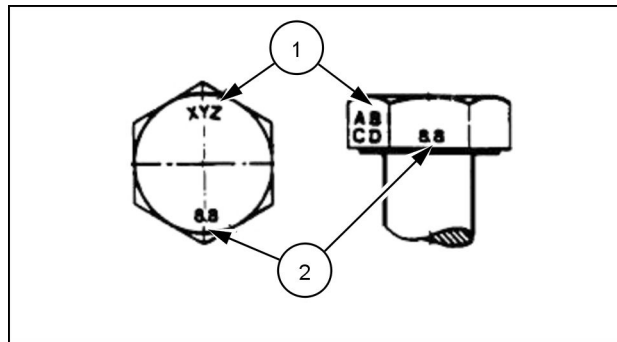

20083680 1

1. Manufacturer's Identification
2. Property Class

**Metric Hex nuts and locknuts, classes 05 and up**

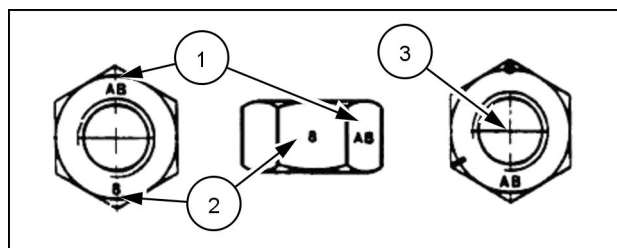

20083681 2

1. Manufacturer's Identification
2. Property Class
3. Clock Marking of Property Class and Manufacturer's Identification (Optional), i.e. marks **60 °** apart indicate Class 10 properties, and marks **120 °** apart indicate Class 8.

**INCH NON-FLANGED HARDWARE**

NOMINAL SIZE	SAE GRADE 5 BOLT and NUT		SAE GRADE 8 BOLT and NUT		LOCKNUT GrB W/ Gr5 BOLT	LOCKNUT GrC W/ Gr8 BOLT
	UN-PLATED or PLATED SILVER	PLATED W/ZnCr GOLD	UN-PLATED or PLATED SILVER	PLATED W/ZnCr GOLD		
1/4	8 N·m (71 lb in)	11 N·m (97 lb in)	12 N·m (106 lb in)	16 N·m (142 lb in)	8.5 N·m (75 lb in)	12.2 N·m (109 lb in)
5/16	17 N·m (150 lb in)	23 N·m (204 lb in)	24 N·m (212 lb in)	32 N·m (283 lb in)	17.5 N·m (155 lb in)	25 N·m (220 lb in)
3/8	30 N·m (22 lb ft)	40 N·m (30 lb ft)	43 N·m (31 lb ft)	57 N·m (42 lb ft)	31 N·m (23 lb ft)	44 N·m (33 lb ft)
7/16	48 N·m (36 lb ft)	65 N·m (48 lb ft)	68 N·m (50 lb ft)	91 N·m (67 lb ft)	50 N·m (37 lb ft)	71 N·m (53 lb ft)
1/2	74 N·m (54 lb ft)	98 N·m (73 lb ft)	104 N·m (77 lb ft)	139 N·m (103 lb ft)	76 N·m (56 lb ft)	108 N·m (80 lb ft)
9/16	107 N·m (79 lb ft)	142 N·m (105 lb ft)	150 N·m (111 lb ft)	201 N·m (148 lb ft)	111 N·m (82 lb ft)	156 N·m (115 lb ft)
5/8	147 N·m (108 lb ft)	196 N·m (145 lb ft)	208 N·m (153 lb ft)	277 N·m (204 lb ft)	153 N·m (113 lb ft)	215 N·m (159 lb ft)
3/4	261 N·m (193 lb ft)	348 N·m (257 lb ft)	369 N·m (272 lb ft)	491 N·m (362 lb ft)	271 N·m (200 lb ft)	383 N·m (282 lb ft)
7/8	420 N·m (310 lb ft)	561 N·m (413 lb ft)	594 N·m (438 lb ft)	791 N·m (584 lb ft)	437 N·m (323 lb ft)	617 N·m (455 lb ft)
1	630 N·m (465 lb ft)	841 N·m (620 lb ft)	890 N·m (656 lb ft)	1187 N·m (875 lb ft)	654 N·m (483 lb ft)	924 N·m (681 lb ft)

**NOTE:** For Imperial Units, *1/4 in* and *5/16 in* hardware torque specifications are shown in pound-inches. *3/8 in* through *1 in* hardware torque specifications are shown in pound-feet.

**INCH FLANGED HARDWARE**

NOM- INAL SIZE	SAE GRADE 5 BOLT and NUT		SAE GRADE 8 BOLT and NUT		LOCKNUT GrF W/ Gr5 BOLT	LOCKNUT GrG W/ Gr8 BOLT
	UNPLATED or PLATED SILVER	PLATED W/ZnCr GOLD	UNPLATED or PLATED SILVER	PLATED W/ZnCr GOLD		
1/4	9 N·m (80 lb in)	12 N·m (106 lb in)	13 N·m (115 lb in)	17 N·m (150 lb in)	8 N·m (71 lb in)	12 N·m (106 lb in)
5/16	19 N·m (168 lb in)	25 N·m (221 lb in)	26 N·m (230 lb in)	35 N·m (310 lb in)	17 N·m (150 lb in)	24 N·m (212 lb in)
3/8	33 N·m (25 lb ft)	44 N·m (33 lb ft)	47 N·m (35 lb ft)	63 N·m (46 lb ft)	30 N·m (22 lb ft)	43 N·m (32 lb ft)
7/16	53 N·m (39 lb ft)	71 N·m (52 lb ft)	75 N·m (55 lb ft)	100 N·m (74 lb ft)	48 N·m (35 lb ft)	68 N·m (50 lb ft)
1/2	81 N·m (60 lb ft)	108 N·m (80 lb ft)	115 N·m (85 lb ft)	153 N·m (113 lb ft)	74 N·m (55 lb ft)	104 N·m (77 lb ft)
9/16	117 N·m (86 lb ft)	156 N·m (115 lb ft)	165 N·m (122 lb ft)	221 N·m (163 lb ft)	106 N·m (78 lb ft)	157 N·m (116 lb ft)
5/8	162 N·m (119 lb ft)	216 N·m (159 lb ft)	228 N·m (168 lb ft)	304 N·m (225 lb ft)	147 N·m (108 lb ft)	207 N·m (153 lb ft)
3/4	287 N·m (212 lb ft)	383 N·m (282 lb ft)	405 N·m (299 lb ft)	541 N·m (399 lb ft)	261 N·m (193 lb ft)	369 N·m (272 lb ft)
7/8	462 N·m (341 lb ft)	617 N·m (455 lb ft)	653 N·m (482 lb ft)	871 N·m (642 lb ft)	421 N·m (311 lb ft)	594 N·m (438 lb ft)
1	693 N·m (512 lb ft)	925 N·m (682 lb ft)	979 N·m (722 lb ft)	1305 N·m (963 lb ft)	631 N·m (465 lb ft)	890 N·m (656 lb ft)

**IDENTIFICATION**

**Inch Bolts and free-spinning nuts**

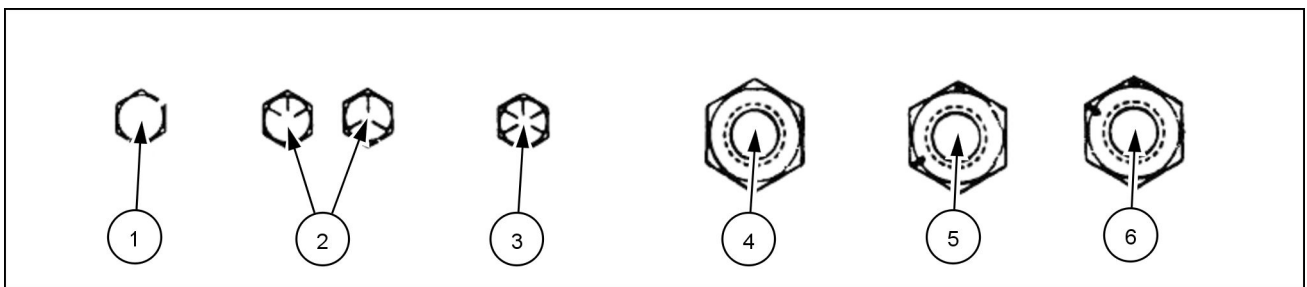

20083682 3

**Grade Marking Examples**

SAE Grade Identification			
1	Grade 2 - No Marks	4	Grade 2 Nut - No Marks
2	Grade 5 - Three Marks	5	Grade 5 Nut - Marks 120 ° Apart
3	Grade 8 - Five Marks	6	Grade 8 Nut - Marks 60 ° Apart

**Inch Lock Nuts, All Metal (Three optional methods)**

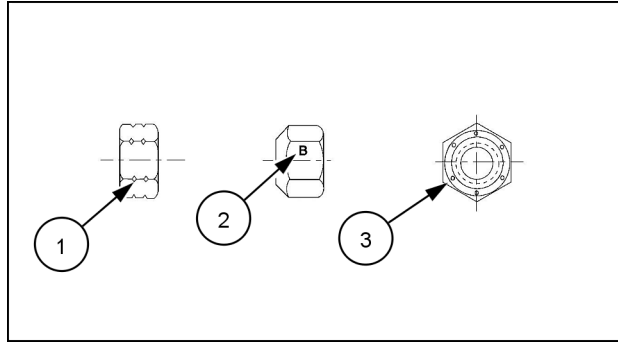

20090268 4

**Grade Identification**

Grade	Corner Marking Method (1)	Flats Marking Method (2)	Clock Marking Method (3)
Grade A	No Notches	No Mark	No Marks
Grade B	One Circumferential Notch	Letter B	Three Marks
Grade C	Two Circumferential Notches	Letter C	Six Marks



---

## Basic instructions - Shop and Assembly

### SHIMMING

For each adjustment operation, select adjusting shims and measure individually using a micrometer, then add up the recorded values. Do not rely on measuring the entire shimming set, which may be incorrect, or the rated value indicated on each shim.

### ROTATING SHAFT SEALS

For correct rotating shaft seal installation, proceed as follows:

- before assembly, allow the seal to soak in the oil it will be sealing for at least thirty minutes.
- thoroughly clean the shaft and check that the working surface on the shaft is not damaged.
- position the sealing lip facing the fluid; with hydrodynamic lips, take into consideration the shaft rotation direction and position the grooves so that they will deviate the fluid towards the inner side of the seal.
- coat the sealing lip with a thin layer of lubricant (use oil rather than grease) and fill the gap between the sealing lip and the dust lip on double lip seals with grease.
- insert the seal in its seat and press down using a flat punch or seal installation tool. Do not tap the seal with a hammer or mallet.
- whilst inserting the seal, check that it is perpendicular to the seat; once settled, make sure that it makes contact with the thrust element, if required.
- to prevent damaging the seal lip on the shaft, position a protective guard during installation operations.

### O-RING SEALS

Lubricate the O-RING seals before inserting them in the seats, this will prevent them from overturning and twisting, which would jeopardise sealing efficiency.

### SEALING COMPOUNDS

Apply one of the following sealing compounds on the mating surfaces when specified: SILMATE® RTV1473, or **LOCTITE RTV 598** or **LOCTITE® INSTANT GASKET 587 BLUE**. Before applying the sealing compound, prepare the surfaces as directed on product container or as follows:

- remove any incrustations using a metal brush.
- thoroughly de-grease the surfaces using a locally approved cleaning agent such as safety solvent or brake parts cleaner.

### SPARE PARTS

Only use "CNH Original Parts" or " CNH Parts".

Only genuine spare parts guarantee the same quality, duration and safety as original parts, as they are the same parts that are assembled during standard production. Only "CNH Original Parts" or " CNH Parts" can offer this guarantee.

When ordering spare parts, always provide the following information:

- machine model (commercial name) and serial number
- part number of the ordered part, which can be found in the "Microfiches" or the "Service Parts Catalogue", used for order processing

---

## PROTECTING THE ELECTRONIC/ ELECTRICAL SYSTEMS DURING CHARGING OR WELDING

To avoid damage to the electronic/electrical systems, always observe the following:

1. Never make or break any of the charging circuit connections, including the battery connections, when the engine is running.
2. Never short any of the charging components to ground.
3. Always disconnect the ground cable from the battery before arc welding on the combine or on any header attached to the combine.
  - position the welder ground clamp as close to the welding area as possible
  - if welding in close proximity to a computer module, then the module should be removed from the combine
  - never allow welding cables to lay on, near or across any electrical wiring or electronic component while welding is in progress
4. Always disconnect the negative cable from the battery when charging the battery in the combine with a battery charger.

**NOTICE:** *If welding must be performed on the unit, either the combine or the header (if it is attached), the battery ground cable must be disconnected from the combine battery. The electronic monitoring system and charging system will be damaged if this is not done.*

Remove the battery ground cable. Reconnect the cable when welding is completed.



**Battery acid causes severe burns. Batteries contain sulfuric acid. Avoid contact with skin, eyes or clothing. Antidote - EXTERNAL: flush with water. INTERNAL: drink large quantities of water or milk. Follow with milk of magnesia, beaten egg or vegetables oil. Call physician immediately. EYES: flush with water for 15 minutes and get prompt medical attention.**

84-110

## TOOLS

The tools that CNH suggests and illustrate in this manual have been:

- specifically researched and designed for use with CNH machines
- essential for reliable repair operations
- accurately built and rigorously tested so as to offer efficient and long-lasting operation

By using these tools, repair personnel will benefit from:

- operating in optimal technical conditions
- obtaining the best results
- saving time and effort
- working in safe conditions

**NOTE:** *The terms "front", "rear", "right-hand" and "left-hand" (when referred to different parts) are determined from the rear, facing in the direction of travel of the machine during operation.*

# CONSUMABLES INDEX

---

<b>Consumable</b>	<b>Reference</b>	<b>PAGE</b>
Loctite RTV 598	Basic instructions - Shop and Assembly	15
Loctite® Instant Gasket 587 Blue	Basic instructions - Shop and Assembly	15



## SERVICE MANUAL

### Engine

**F4DFE413A\*A, F4DFE413B\*A, F4DFE413C\*A, F4DFE413D\*A, F4DFE413E\*A,  
F4DFE6132\*A, F4DFE613A\*A, F4DFE613B\*A, F4DFE613C\*A, F4DFE613D\*A,  
F4DFE613E\*A, F4DFE613F\*A, F4DFE613G\*A, F4DFE613H\*A, F4DFE613J\*A,  
F4DFE613K\*A, F4DFE613L\*A, F4HFE413A\*A005, F4HFE413C\*A,  
F4HFE413D\*A008, F4HFE413H\*A, F4HFE413J\*A, F4HFE413L\*A007,  
F4HFE413M\*A005, F4HFE413P\*A001, F4HFE6131\*A, F4HFE6132\*A004,  
F4HFE6138\*A002, F4HFE613F\*A002, F4HFE613G\*A, F4HFE613H\*A,  
F4HFE613J\*A007, F4HFE613J\*A, F4HFE613K\*A, F4HFE613P\*A,  
F4HFE613R\*A, F4HFE613T\*A004, F4HFE613T\*A005, F4HFE613U\*A005,  
F4HFE613U\*A006, F4HFE613V\*A003, F4HFE613X\*A, F4HFE613Y\*A,  
F4HFE613Z\*A005, F4HFE613Z\*A006, F4HFE614E\*A001**

# Contents

---

## Engine - 10

[10.001] Engine and crankcase .....	10.1
[10.102] Pan and covers .....	10.2
[10.106] Valve drive and gears .....	10.3
[10.101] Cylinder heads .....	10.4
[10.105] Connecting rods and pistons .....	10.5
[10.103] Crankshaft and flywheel.....	10.6
[10.110] Balancer and damper .....	10.7
[10.114] Pump drives .....	10.8
[10.210] Lift pump and lines .....	10.9
[10.206] Fuel filters .....	10.10
[10.218] Fuel injection system.....	10.11
[10.250] Turbocharger and lines.....	10.12
[10.254] Intake and exhaust manifolds and muffler .....	10.13
[10.500] Selective Catalytic Reduction (SCR) exhaust treatment.....	10.14
[10.400] Engine cooling system .....	10.15
[10.414] Fan and drive .....	10.16
[10.304] Engine lubrication system.....	10.17
[10.408] Oil cooler and lines.....	10.18

# CONSUMABLES INDEX

---

<b>Consumable</b>	<b>Reference</b>	<b>PAGE</b>
Loctite® 5205	Engine block cover Front - Cleaning	10.2 / 10
Loctite® 5205	Engine block cover Front - Install	10.2 / 11
Loctite® 5205	Engine block cover Rear - Cleaning	10.2 / 17
Loctite® 518™ Gasket Eliminator®	Engine block cover Rear - Cleaning	10.2 / 21
Loctite® 5205	Timing gear housing - Cleaning	10.2 / 24
Molykote® G-N Metal assembly paste	Cylinder head - Install	10.4 / 12
Mobilux® EP 023	Common rail Relief valve - Install	10.11 / 39
Mobilux® EP 023	Common rail Relief valve - Install	10.11 / 39
Loctite® 5999™	Intake manifold - Install	10.13 / 8



## Engine - 10

### Engine and crankcase - 001

**F4DFE413A\*A, F4DFE413B\*A, F4DFE413C\*A, F4DFE413D\*A, F4DFE413E\*A,  
F4DFE6132\*A, F4DFE613A\*A, F4DFE613B\*A, F4DFE613C\*A, F4DFE613D\*A,  
F4DFE613E\*A, F4DFE613F\*A, F4DFE613G\*A, F4DFE613H\*A, F4DFE613J\*A,  
F4DFE613K\*A, F4DFE613L\*A, F4HFE413A\*A005, F4HFE413C\*A,  
F4HFE413D\*A008, F4HFE413H\*A, F4HFE413J\*A, F4HFE413L\*A007,  
F4HFE413M\*A005, F4HFE413P\*A001, F4HFE6131\*A, F4HFE6132\*A004,  
F4HFE6138\*A002, F4HFE613F\*A002, F4HFE613G\*A, F4HFE613H\*A,  
F4HFE613J\*A007, F4HFE613J\*A, F4HFE613K\*A, F4HFE613P\*A,  
F4HFE613R\*A, F4HFE613T\*A004, F4HFE613T\*A005, F4HFE613U\*A005,  
F4HFE613U\*A006, F4HFE613V\*A003, F4HFE613X\*A, F4HFE613Y\*A,  
F4HFE613Z\*A005, F4HFE613Z\*A006, F4HFE614E\*A001**

# Contents

---

## Engine - 10

### Engine and crankcase - 001

#### TECHNICAL DATA

Engine	
Torque .....	3
Technical Data .....	5

#### FUNCTIONAL DATA

Engine	
Component localization .....	6
Component localization (*) .....	7

#### SERVICE

Engine	
Service instruction Maintenance procedures .....	9
Service instruction - Finding Top Dead Center (TDC) .....	13
Compression test .....	14
Crankcase	
Bore - Check .....	15
Check .....	16
Pressure test .....	17

#### DIAGNOSTIC

Engine	
Troubleshooting .....	18

(\*) See content for specific models



## Engine - Torque

Component	Size	Specification
<b>Cylinder head and components</b>		
Plug	1/4"	10 - 14 Nm (7.4 - 10.3 lb ft)
	1/2"	20 - 28 Nm (14.8 - 20.7 lb ft)
	3/4"	31 - 41 Nm (22.9 - 30.2 lb ft)
Grid heater	M6 Nut	6 - 10 Nm (4.4 - 7.4 lb ft)
Intake manifold	M8 Screw	20 - 28 Nm (14.8 - 20.7 lb ft)
<b>Engine lifting bracket</b>		
Rear	M12	65 - 89 Nm (47.9 - 65.6 lb ft)
Front	M8	20 - 28 Nm (14.8 - 20.7 lb ft)
Cylinder head	<b>M12x1.75x130 mm</b>	
First phase		30 - 40 Nm (22.1 - 29.5 lb ft)
Second phase		85 - 95 °
Third phase		85 - 95 °
Cylinder head	<b>M12x1.75x150 mm</b>	
First phase		50 - 60 Nm (36.9 - 44.3 lb ft)
Second phase		85 - 95 °
Third phase		85 - 95 °
Rocker bracket		31 - 41 Nm (22.9 - 30.2 lb ft)
Rocker arm jam nuts		20 - 28 Nm (14.8 - 20.7 lb ft)
Exhaust manifold		48 - 58 Nm (35.4 - 42.8 lb ft)
Valve cover	M8 Nut	20 - 28 Nm (14.8 - 20.7 lb ft)
<b>Turbocharger</b>		
6 Cylinder	M8 Screw	6 - 8 Nm (4.4 - 5.9 lb ft)
	M8 Nut	37 - 49 Nm (27.3 - 36.1 lb ft)
4 Cylinder	M8 Screw	6 - 8 Nm (4.4 - 5.9 lb ft)
	M8 Nut	20 - 28 Nm (14.8 - 20.7 lb ft)
<b>Front case</b>		
Front cover	M8 Screw	20 - 28 Nm (14.8 - 20.7 lb ft)
<b>Rear case</b>		
Gear case	M12 Screw	65 - 89 Nm (47.9 - 65.6 lb ft)
	M10 Screw	42 - 52 Nm (31.0 - 38.4 lb ft)
	M8 Screw	20 - 28 Nm (14.8 - 20.7 lb ft)
Flywheel housing	M10	75 - 95 Nm (55.3 - 70.1 lb ft)
	M12	44 - 54 Nm (32.5 - 39.8 lb ft)
<b>Cylinder block and crankshaft components</b>		
Camshaft retaining plate	M8 Screw	20 - 28 Nm (14.8 - 20.7 lb ft)
Camshaft gear	M8 Screw	32 - 40 Nm (23.6 - 29.5 lb ft)
Crankcase plate	M10 Screw	38 - 48 Nm (28.0 - 35.4 lb ft)
<b>Vibration damper and adapter</b>		
First phase		45 - 55 Nm (33.2 - 40.6 lb ft)
Second phase		90 °
Drive pulley	M10	61 - 75 Nm (45.0 - 55.3 lb ft)
<b>Engine flywheel</b>		
First phase		26 - 34 Nm (19.2 - 25.1 lb ft)
Second phase		55 - 65 °
<b>Main caps</b>		
First phase	M12	44 - 56 Nm (32.5 - 41.3 lb ft)
Second phase		74 - 86 Nm (54.6 - 63.4 lb ft)
Third phase		85 - 95 °
<b>Connecting rod caps</b>		
First phase		45.0 - 55.0 N·m (33.2 - 40.6 lb ft)
Second phase		55 - 65 °
<b>Lubrication system and components</b>		

Engine - Engine and crankcase

Component	Size	Specification
<b>Oil pump</b>		
First phase	M8	7 - 9 Nm (5.2 - 6.6 lb ft)
Second phase	M8	20 - 28 Nm (14.8 - 20.7 lb ft)
Oil pressure relief valve	M22	72 - 88 Nm (53.1 - 64.9 lb ft)
Oil cooler and oil filter base	M8 Screw	20 - 28 Nm (14.8 - 20.7 lb ft)
Oil Filter		Contact + ¼ Turn
Connection on filter base for turbo oil supply	1 ⅛"	20 - 28 Nm (14.8 - 20.7 lb ft)
Turbo lubrication pipe	M12 Nut	8 - 12 Nm (5.9 - 8.9 lb ft)
Turbo lubrication pipe adapter	M12	30 - 40 Nm (22.1 - 29.5 lb ft)
Oil pan		20 - 28 Nm (14.8 - 20.7 lb ft)
Piston spray nozzles	M8	12 - 18 Nm (8.9 - 13.3 lb ft)
<b>Electrical components</b>		
Camshaft sensor	M6 Studs	6 - 10 Nm (4.4 - 7.4 lb ft)
	M6 Nut	8 - 12 Nm (5.9 - 8.9 lb ft)
	M6 Screw	6 - 10 Nm (4.4 - 7.4 lb ft)
Wiring bulkhead	M6 Screw	8 - 12 Nm (5.9 - 8.9 lb ft)
Support bracket for injector wiring	M8 Screw	20 - 28 Nm (14.8 - 20.7 lb ft)
Injector wiring		1.25 - 1.75 Nm (0.92 - 1.29 lb ft)
ECU cooling plate	M6 Screw	8 - 12 Nm (5.9 - 8.9 lb ft)
	M8 Screw	20 - 28 Nm (14.8 - 20.7 lb ft)
Fuel outlet	M12	10 - 14 Nm (7.4 - 10.3 lb ft)
Fuel inlet	M12	10 - 14 Nm (7.4 - 10.3 lb ft)
Crankshaft speed sensor	M6 Screw	6 - 10 Nm (4.4 - 7.4 lb ft)
Coolant temperature sensor	M14 Screw	17 - 23 Nm (12.5 - 17.0 lb ft)
Oil pressure / Temperature sensor	M5 Screw	5 - 7 Nm (3.7 - 5.2 lb ft)
Fuel pressure sensor		30 - 40 Nm (22.1 - 29.5 lb ft)
Fuel temperature sensor	M14	17 - 23 Nm (12.5 - 17.0 lb ft)
Air pressure / Temperature sensor		5 - 7 Nm (3.7 - 5.2 lb ft)
Engine oil level sensor	M12	10 - 14 Nm (7.4 - 10.3 lb ft)
Alternator support bracket	M10 Screw	37 - 49 Nm (27.3 - 36.1 lb ft)
Alternator tension bracket	M10 Screw	37 - 49 Nm (27.3 - 36.1 lb ft)
Starter		37 - 49 Nm (27.3 - 36.1 lb ft)
<b>Fuel system and components</b>		
Feed pump	M8 Studs	10 - 14 Nm (7.4 - 10.3 lb ft)
High pressure pump gear	M18 Nut	100 - 110 Nm (73.8 - 81.1 lb ft)
Fuel pump	M8 Nut	20 - 28 Nm (14.8 - 20.7 lb ft)
<b>Injector</b>		
First phase	M6 Screw	8.15 - 8.85 Nm (6.0 - 6.5 lb ft)
Second phase	M6 Screw	70 - 80 °
Injector feed connector		45 - 55 Nm (33.2 - 40.6 lb ft)
Common rail	M8 Screw	20 - 28 Nm (14.8 - 20.7 lb ft)
High pressure fuel line	M14 Fitting	18 - 22 Nm (13.3 - 16.2 lb ft)
High pressure pipe connector	M8 Screw	20 - 28 Nm (14.8 - 20.7 lb ft)
Fuel filter bracket	M12 Screw	71 - 85 Nm (52.4 - 62.7 lb ft)
Fuel filter holder	M8 Screw	20 - 28 Nm (14.8 - 20.7 lb ft)
Fuel filter		Contact + ¼ Turn
<b>Cooling system and components</b>		
Engine coolant inlet	M10 Screw	37 - 49 Nm (27.3 - 36.1 lb ft)
Fitting on coolant inlet	90 ° Elbow	20 - 28 Nm (14.8 - 20.7 lb ft)
Compressor cooling pipe		20 - 24 Nm (14.8 - 17.7 lb ft)
Engine coolant drain collector	M6 Screw	8 - 12 Nm (5.9 - 8.9 lb ft)
Water pump	M8 Screw	20 - 28 Nm (14.8 - 20.7 lb ft)
Belt tensioner	M10	37 - 49 Nm (27.3 - 36.1 lb ft)
Idler pulleys	M10	37 - 49 Nm (27.3 - 36.1 lb ft)

## Engine - Technical Data

General specifications		
Engine type	4 Cylinders	6 Cylinders
Cycle	Four-Stroke diesel engine	
Power	Turbocharged with intercooler	
Injection	Direct	
Number of cylinders	4	6
Bore	104 mm (4 in)	
Stroke	132 mm (5 in)	
Total displacement	4485 cm <sup>3</sup>	6728 cm <sup>3</sup>
Timing		
Start before T.D.C.	18.5 °	
End after B.D.C.	29.5 °	
Start before B.D.C.	67 °	
End after T.D.C.	35 °	
Valve clearance		
Intake	0.20 - 0.30 mm (0.008 - 0.012 in)	
Exhaust	0.45 - 0.55 mm (0.018 - 0.022 in)	
Fuel feed		
Injection type	Bosch high pressure common rail	
Control	EDC7 UC31	
Injector	CRIN 2	
Nozzle type	DLLA	
Injection sequence	1-3-4-2	1-5-3-6-2-4
Injection pressure	250 - 1600 bar (3625 - 23200 psi)	
Aspiration		
Turbocharging	Intercooled	
Turbocharger type	Honeywell GT25	Holset HX35
Lubrication		
Oil pressure @ low idle	2.0 bar (29.0 psi)	
Oil pressure @ fast idle	4.0 bar (58.0 psi)	
Oil pan capacity	15 l (15.85 US qt)	
Oil filter capacity	1 l (1.06 US qt)	
Cooling		
Water pump	Belt driven	
Thermostat	79 - 83 °C (174 - 181 °F)	

## Engine - Component localization

### Location of main electrical components

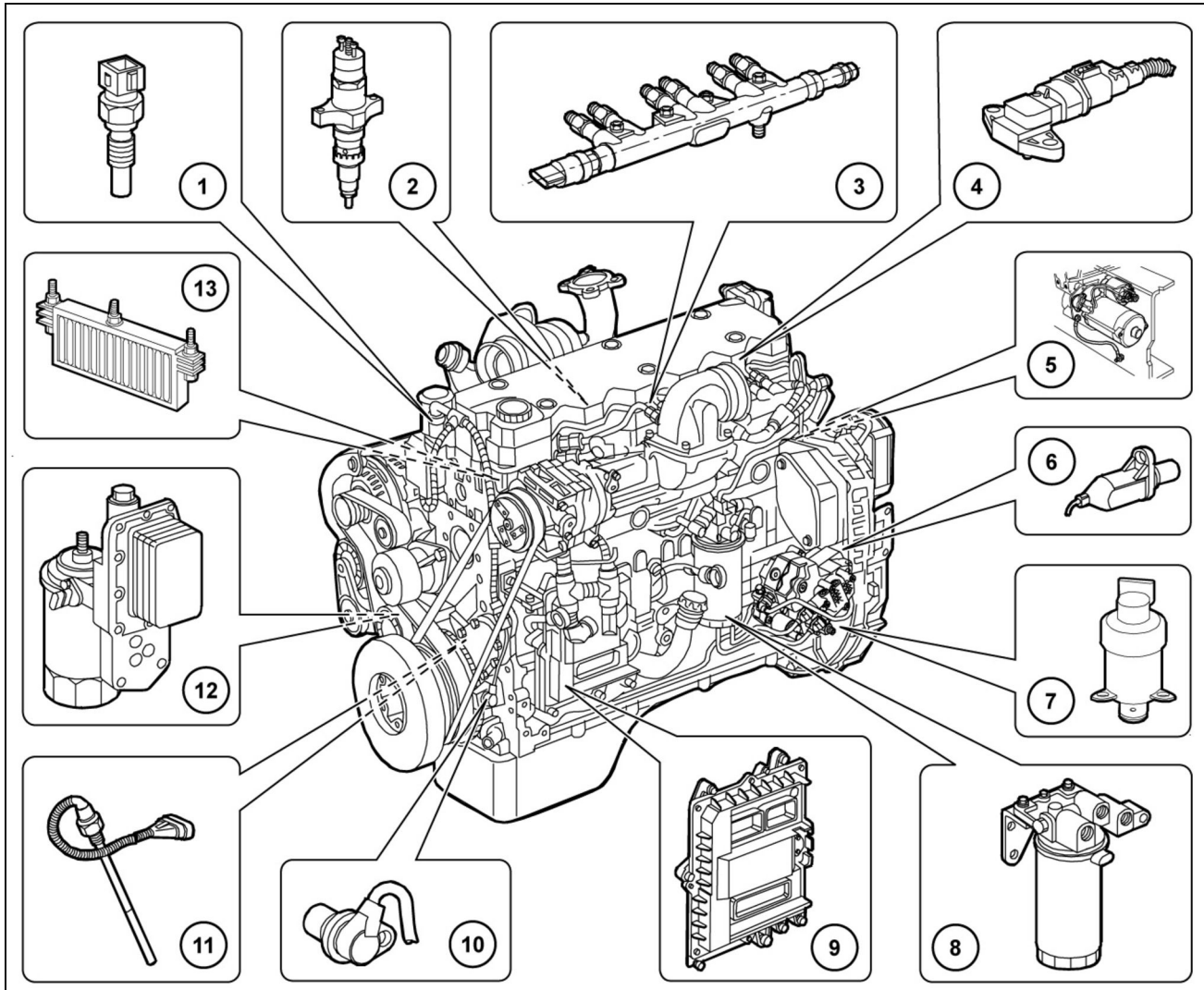

CRIL04D081G01 1

- |   |   |
|---|---|
| (1) Coolant temperature sensor            | (8) Fuel temperature sensor                 |
| (2) Electro injector                      | (9) EDC17 CV41                              |
| (3) Rail pressure sensor                  | (10) Crankshaft sensor                      |
| (4) Air temperature/Pressure sensor       | (11) Oil level sensor                       |
| (5) Engine starter                        | (12) Engine oil temperature/Pressure sensor |
| (6) Timing sensor                         | (13) Heating element for pre-post heating   |
| (7) Solenoid valve for pressure regulator |   |

The NEF F4HFE engines are fully driven by the electronic engine control module, which is assembled directly to the engine by means of a heat exchanger enabling its cooling, utilizing rubber buffers to reduce vibration originated by the engine.

Through the engine control module it is possible to verify the correct working of the engine.

Thank you so much for reading.  
Please click the “Buy Now!”  
button below to download the  
complete manual.



After you pay.

You can download the most  
perfect and complete manual in  
the world immediately.

Our support email:

[ebooklibonline@outlook.com](mailto:ebooklibonline@outlook.com)