

**DC93**  
**DCI03**  
Disc Mower-Conditioner

**SERVICE MANUAL**

**Part number 51586250**

1<sup>st</sup> edition English

February 2019





# SERVICE MANUAL

DC103  
DC93

# Contents

---

## INTRODUCTION

<b>Power Take-Off (PTO)</b> .....	<b>31</b>
[31.201] Power Take-Off (PTO) drive shaft .....	31.1
[31.214] Secondary Power Take-Off (PTO) .....	31.2
[31.215] Intermediate Power Take-Off (PTO) .....	31.3
[31.220] Gearbox .....	31.4
[31.225] Clutches .....	31.5
<b>Hydraulic systems</b> .....	<b>35</b>
[35.000] Hydraulic systems.....	35.1
[35.410] Header or attachment height system .....	35.2
[35.415] Header or attachment tilting system .....	35.3
[35.947] Frame positioning swinging .....	35.4
<b>Wheels</b> .....	<b>44</b>
[44.530] Carrying and transport wheels .....	44.1
<b>Electrical systems</b> .....	<b>55</b>
[55.100] Harnesses and connectors .....	55.1
[55.404] External lighting .....	55.2
<b>Attachments/Headers</b> .....	<b>58</b>
[58.110] Attachment/Header cutting mechanism .....	58.1
[58.130] Attachment/Header frame .....	58.2
<b>Product feeding</b> .....	<b>60</b>
[60.120] Header drive system .....	60.1
[60.620] Roll conditioning .....	60.2
[60.630] Flail conditioning .....	60.3



# INTRODUCTION

# Contents

---

## INTRODUCTION

Foreword - Important notice regarding equipment servicing .....	3
Safety rules .....	4
Safety rules - Personal safety .....	5
Safety rules - Ecology and the environment .....	11
Torque - Nominal tightening torques for normal assembly .....	12
Torque - Standard torque data for hydraulic connections .....	17
Basic instructions - Shop and assembly .....	24
General specification .....	26
General specification (*) .....	28
Capacities .....	30
Product identification .....	31
Product identification - Machine orientation .....	32

(\*) See content for specific models

---

## **Foreword - Important notice regarding equipment servicing**

All repair and maintenance work listed in this manual must be carried out only by qualified dealership personnel, strictly complying with the instructions given, and using, whenever possible, the special tools.

Anyone who performs repair and maintenance operations without complying with the procedures provided herein shall be responsible for any subsequent damages.

The manufacturer and all the organizations of its distribution chain, including - without limitation - national, regional, or local dealers, reject any responsibility for damages caused by parts and/or components not approved by the manufacturer, including those used for the servicing or repair of the product manufactured or marketed by the manufacturer. In any case, no warranty is given or attributed on the product manufactured or marketed by the manufacturer in case of damages caused by parts and/or components not approved by the manufacturer.

The manufacturer reserves the right to make improvements in design and changes in specifications at any time without notice and without incurring any obligation to install them on units previously sold. Specifications, descriptions, and illustrative material herein are as accurate as known at time of publication but are subject to change without notice.

In case of questions, refer to your CASE IH Sales and Service Networks.

## Safety rules

### Personal safety





This is the safety alert symbol. It is used to alert you to potential personal injury hazards. Obey all safety messages that follow this symbol to avoid possible death or injury.

Throughout this manual you will find the signal words DANGER, WARNING, and CAUTION followed by special instructions. These precautions are intended for the personal safety of you and those working with you.

Read and understand all the safety messages in this manual before you operate or service the machine.

 DANGER indicates a hazardous situation that, if not avoided, will result in death or serious injury.

 WARNING indicates a hazardous situation that, if not avoided, could result in death or serious injury.

 CAUTION indicates a hazardous situation that, if not avoided, could result in minor or moderate injury.

**FAILURE TO FOLLOW DANGER, WARNING, AND CAUTION MESSAGES COULD RESULT IN DEATH OR SERIOUS INJURY.**

### Machine safety

**NOTICE:** Notice indicates a situation that, if not avoided, could result in machine or property damage.

Throughout this manual you will find the signal word Notice followed by special instructions to prevent machine or property damage. The word Notice is used to address practices not related to personal safety.

### Information

**NOTE:** Note indicates additional information that clarifies steps, procedures, or other information in this manual.

Throughout this manual you will find the word Note followed by additional information about a step, procedure, or other information in the manual. The word Note is not intended to address personal safety or property damage.

---

## Safety rules - Personal safety

### General safety rules

Use caution when you operate the machine on slopes. Raised equipment, full tanks and other loads will change the center of gravity of the machine. The machine can tip or roll over when near ditches and embankments or uneven surfaces.

Never permit anyone other than the operator to ride on the machine.

Never operate the machine under the influence of alcohol or drugs, or while you are otherwise impaired.

When digging or using ground-engaging attachments, be aware of buried cables. Contact local utilities to determine the locations of services.

Pay attention to overhead power lines and hanging obstacles. High voltage lines may require significant clearance for safety.

Hydraulic oil or diesel fuel leaking under pressure can penetrate the skin, causing serious injury or infection.

- DO NOT use your hand to check for leaks. Use a piece of cardboard or paper.
- Stop the engine, remove the key, and relieve the pressure before you connect or disconnect fluid lines.
- Make sure that all components are in good condition. Tighten all connections before you start the engine or pressurize the system.
- If hydraulic fluid or diesel fuel penetrates the skin, seek medical attention immediately.
- Continuous long term contact with hydraulic fluid may cause skin cancer. Avoid long term contact and wash the skin promptly with soap and water.

Keep clear of moving parts. Loose clothing, jewelry, watches, long hair, and other loose or hanging items can become entangled in moving parts.

Wear protective equipment when appropriate.

DO NOT attempt to remove material from any part of the machine while it is being operated or while components are in motion.

Make sure that all guards and shields are in good condition and properly installed before you operate the machine. Never operate the machine with shields removed. Always close access doors or panels before you operate the machine.

Dirty or slippery steps, ladders, walkways, and platforms can cause falls. Make sure these surfaces remain clean and clear of debris.

A person or pet within the operating area of a machine can be struck or crushed by the machine or its equipment. DO NOT allow anyone to enter the work area.

Raised equipment and/or loads can fall unexpectedly and crush persons underneath. Never allow anyone to enter the area underneath raised equipment during operation.



---

## **General maintenance safety**

Keep the area used for servicing the machine clean and dry. Clean up spilled fluids.

Service the machine on a firm, level surface.

Install guards and shields after you service the machine.

Close all access doors and install all panels after servicing the machine.

Do not attempt to clean, lubricate, clear obstructions, or make adjustments to the machine while it is in motion or while the engine is running.

Always make sure that working area is clear of tools, parts, other persons and pets before you start operating the machine.

Unsupported hydraulic cylinders can lose pressure and drop the equipment, causing a crushing hazard. Do not leave equipment in a raised position while parked or during service, unless the equipment is securely supported.

Jack or lift the machine only at jack or lift points indicated in this manual.

Incorrect towing procedures can cause accidents. When you tow a disabled machine follow the procedure in this manual. Use only rigid tow bars.

Stop the engine, remove the key, and relieve pressure before you connect or disconnect fluid lines.

Stop the engine and remove the key before you connect or disconnect electrical connections.

Scalding can result from incorrect removal of coolant caps. Cooling systems operate under pressure. Hot coolant can spray out if you remove a cap while the system is hot. Allow the system to cool before you remove the cap. When you remove the cap, turn it slowly to allow pressure to escape before you completely remove the cap.

Replace damaged or worn tubes, hoses, electrical wiring, etc.

The engine, transmission, exhaust components, and hydraulic lines may become hot during operation. Take care when you service such components. Allow surfaces to cool before you handle or disconnect hot components. Wear protective equipment when appropriate.

When welding, follow the instructions in the manual. Always disconnect the battery before you weld on the machine. Always wash your hands after you handle battery components.

## **Wheels and tires**

Make sure that tires are correctly inflated. Do not exceed any recommended load or pressure. Follow the instructions in the manual for proper tire inflation.

Tires are heavy. Handling tires without proper equipment could cause death or serious injury.

Never weld on a wheel with a tire installed. Always remove the tire completely from the wheel prior to welding.

Always have a qualified tire technician service the tires and wheels. If a tire has lost all pressure, take the tire and wheel to a tire shop or your dealer for service. Explosive separation of the tire can cause serious injury.

DO NOT weld to a wheel or rim until the tire is completely removed. Inflated tires can generate a gas mixture with the air that can be ignited by high temperatures from welding procedures performed on the wheel or rim. Removing the air or loosening the tire on the rim (breaking the bead) will NOT eliminate the hazard. This condition can exist whether tires are inflated or deflated. The tire MUST be completely removed from the wheel or rim prior to welding the wheel or rim.

**⚠️ Driving on public roads and general transportation safety ⚠️**

Comply with local laws and regulations.

Use appropriate lighting to meet local regulations.

Make sure that the SMV emblem (1) is visible.

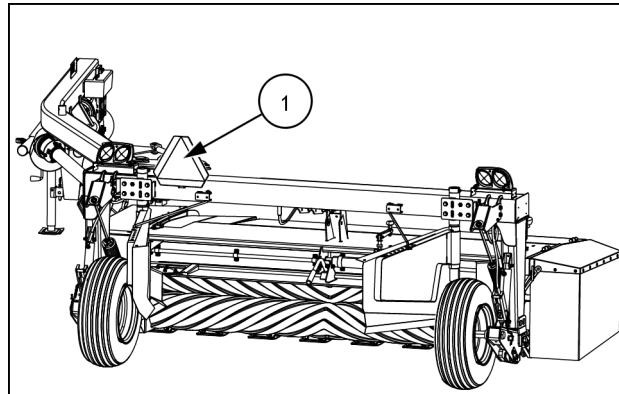

NHIL17HT01486AA 1

Make sure that the brake pedal latch is engaged. You must lock brake pedals together for road travel.

Use safety chains for trailed equipment when safety chains are provided with machine or equipment.

Lift implements and attachments high enough above ground to prevent accidental contact with road.

When you transport equipment or a machine on a transport trailer, make sure that it is properly secured. Be sure the SMV on the equipment or machine is covered while being transported on a trailer.

Be aware of overhead structures or power lines and make sure that the machine and/or attachments can pass safely under.

Travel speed should be such that you maintain complete control and machine stability at all times.

Slow down and signal before turning.

Pull over to allow faster traffic to pass.

Follow correct towing procedure for equipment with or without brakes.

---

 **Fire and explosion prevention** 

Fuel or oil that is leaked or spilled on hot surfaces or electrical components can cause a fire.

Crop materials, trash, debris, bird nests, or flammable material can ignite on hot surfaces.

Always have a fire extinguisher on or near the machine.

Make sure that the fire extinguisher(s) is maintained and serviced according to the manufacturer's instructions.

At least once each day and at the end of the day, remove all trash and debris from the machine especially around hot components such as the engine, transmission, exhaust, battery, etc. More frequent cleaning of your machine may be necessary depending on the operating environment and conditions.

At least once each day, remove debris accumulation around moving components such as bearings, pulleys, belts, gears, cleaning fans, etc. More frequent cleaning of your machine may be necessary depending on the operating environment and conditions.

Inspect the electrical system for loose connections and frayed insulation. Repair or replace loose or damaged parts.

Do not store oily rags or other flammable material on the machine.

Do not weld or flame cut any items that contain flammable material. Clean items thoroughly with non-flammable solvents before welding or flame-cutting.

Do not expose the machine to flames, burning brush, or explosives.

Promptly investigate any unusual smells or odors that may occur during operation of the machine.

## ⚠️ Power Take-Off (PTO) ⚠️

PTO-driven machinery can cause death or serious injury. Before you work on or near the PTO shaft or service or clear the driven machine, put the PTO lever in the disengage position, stop the engine, and remove the key.

Whenever a PTO is in operation, a guard must be in place to prevent death or injury to the operator or bystanders.

When doing stationary PTO work, keep clear of all moving parts and make sure that appropriate guards are in place.

Never use a spline adaptor:

- Match the right tractor PTO spline and speed with the PTO driveshaft provided with an implement. This will assure proper geometry and operating speed.
- Never operate **540 RPM** implements at **1000 RPM**.
- Never operate **1000 RPM** implements at **540 RPM**.
- Use of PTO adaptors will void the warranty of the driveshaft, and the PTO drive train of the machine and implement.
- For correct hitch geometry, see the machine operator's manual.

## ⚠️ Reflectors and warning lights ⚠️

You must use flashing amber warning lights **(1)** when you operate equipment on public roads.

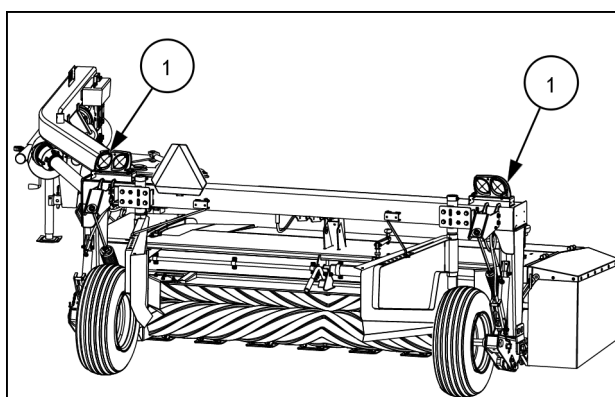

NHIL17HT01486AA 2

## ⚠️ Personal Protective Equipment (PPE) ⚠️

Wear Personal Protective Equipment (PPE) such as hard hat, eye protection, heavy gloves, hearing protection, protective clothing, etc.

## ⚠️ Do Not Operate tag ⚠️

Before you start servicing the machine, attach a 'Do Not Operate' warning tag to the machine in an area that will be visible.

---

 **Hazardous chemicals** 

If you are exposed to or come in contact with hazardous chemicals you can be seriously injured. The fluids, lubricants, paints, adhesives, coolant, etc. required for the function of your machine can be hazardous. They may be attractive and harmful to domestic animals as well as humans.

Material Safety Data Sheets (MSDS) provide information about the chemical substances within a product, safe handling and storage procedures, first aid measures, and procedures to take in the event of a spill or accidental release. MSDS are available from your dealer.

Before you service your machine check the MSDS for each lubricant, fluid, etc. used in this machine. This information indicates the associated risks and will help you service the machine safely. Follow the information in the MSDS, and on manufacturer containers, as well as the information in this manual, when you service the machine.

Dispose of all fluids, filters, and containers in an environmentally safe manner according to local laws and regulations. Check with local environmental and recycling centers or your dealer for correct disposal information.

Store fluids and filters in accordance with local laws and regulations. Use only appropriate containers for the storage of chemicals or petrochemical substances.

Keep out of reach of children or other unauthorized persons.

Applied chemicals require additional precautions. Obtain complete information from the manufacturer or distributor of the chemicals before you use them.

 **Electrical storm safety** 

Do not operate the machine during an electrical storm.

If you are on the ground during an electrical storm, stay away from machinery and equipment. Seek shelter in a permanent, protected structure.

If an electrical storm should strike during operation, remain in the cab. Do not leave the cab or operator's platform. Do not make contact with the ground or objects outside the machine.

---

## Safety rules - Ecology and the environment

Soil, air, and water quality is important for all industries and life in general. When legislation does not yet rule the treatment of some of the substances that advanced technology requires, sound judgment should govern the use and disposal of products of a chemical and petrochemical nature.

Familiarize yourself with the relative legislation applicable to your country, and make sure that you understand this legislation. Where no legislation exists, obtain information from suppliers of oils, filters, batteries, fuels, anti-freeze, cleaning agents, etc., with regard to the effect of these substances on man and nature and how to safely store, use, and dispose of these substances.

### Helpful hints

- Avoid the use of cans or other inappropriate pressurized fuel delivery systems to fill tanks. Such delivery systems may cause considerable spillage.
- In general, avoid skin contact with all fuels, oils, acids, solvents, etc. Most of these products contain substances that may be harmful to your health.
- Modern oils contain additives. Do not burn contaminated fuels and or waste oils in ordinary heating systems.
- Avoid spillage when you drain fluids such as used engine coolant mixtures, engine oil, hydraulic fluid, brake fluid, etc. Do not mix drained brake fluids or fuels with lubricants. Store all drained fluids safely until you can dispose of the fluids in a proper way that complies with all local legislation and available resources.
- Do not allow coolant mixtures to get into the soil. Collect and dispose of coolant mixtures properly.
- The air-conditioning system contains gases that should not be released into the atmosphere. Consult an air-conditioning specialist or use a special extractor to recharge the system properly.
- Repair any leaks or defects in the engine cooling system or hydraulic system immediately.
- Do not increase the pressure in a pressurized circuit as this may lead to a component failure.
- Protect hoses during welding. Penetrating weld splatter may burn a hole or weaken hoses, allowing the loss of oils, coolant, etc.

### Battery recycling

Batteries and electric accumulators contain several substances that can have a harmful effect on the environment if the batteries are not properly recycled after use. Improper disposal of batteries can contaminate the soil, groundwater, and waterways. CASE IH strongly recommends that you return all used batteries to a CASE IH dealer, who will dispose of the used batteries or recycle the used batteries properly. In some countries, this is a legal requirement.



### Mandatory battery recycling

**NOTE:** The following requirements are mandatory in Brazil.

Batteries are made of lead plates and a sulfuric acid solution. Because batteries contain heavy metals such as lead, CONAMA Resolution 401/2008 requires you to return all used batteries to the battery dealer when you replace any batteries. Do not dispose of batteries in your household garbage.

Points of sale are obliged to:

- Accept the return of your used batteries
- Store the returned batteries in a suitable location
- Send the returned batteries to the battery manufacturer for recycling

## Torque - Nominal tightening torques for normal assembly

**NOTE:** In the metric tables, nominal sizes M4 through M8 hardware torque specifications are shown as a Newton meters (pound-inches) numerical value.

Nominal sizes M10 through M24 hardware torque specifications are shown as a Newton meters (pound-feet) numerical value.

### Metric hex head (non-flange) hardware

Plain (PLN) – an unplated hardware finish with residual manufacturing oils

Zinc-dichromate (ZND) – a yellow colored chemical plating formula yellow applied to the hardware

Nominal size	Class (CL) 8.8 bolt and Class (CL) 8 nut	Class (CL) 10.9 bolt and Class (CL) 10 nut	Locknut CL 8 w/CL 8.8 bolt	Locknut CL 10 w/CL 10.9 bolt
	PLN and ZND	PLN and ZND	ZND	ZND
	N·m (lb in)	N·m (lb in)	N·m (lb in)	N·m (lb in)
M4	3.5 (31)	5.0 (44)	1.4 (13)	2.8 (25)
M5	7.0 (62)	10 (88)	2.9 (26)	5.5 (49)
M6	11.8 (104)	17 (150)	4.9 (43)	9.4 (83)
M8	28.8 (255)	41.3 (366)	11.9 (105)	23 (204)
	N·m (lb ft)	N·m (lb ft)	N·m (lb ft)	N·m (lb ft)
M10	57 (42)	82 (60)	24 (17)	45 (33)
M12	100 (74)	143 (105)	41 (30)	79 (38)
M14	159 (117)	227 (168)	66 (48)	125 (92)
M16	248 (183)	354 (261)	102 (75)	195 (144)
M18	352 (260)	487 (359)	145 (107)	268 (198)
M20	500 (369)	690 (509)	206 (152)	380 (280)
M24	865 (638)	1195 (882)	357 (263)	657 (485)

### Metric flange head hardware

Plain (PLN) – an unplated hardware finish with residual manufacturing oils

Zinc-dichromate (ZND) – a yellow colored chemical plating formula yellow applied to the hardware

Nominal size	Class (CL) 8.8 bolt and Class (CL) 8 nut	Class (CL) 10.9 bolt and Class (CL) 10 nut	Flange locknut CL 8 w/CL 8.8 bolt	Flange locknut CL 10 w/CL 10.9 bolt
	PLN and ZND	PLN and ZND	ZND	ZND
	N·m (lb in)	N·m (lb in)	N·m (lb in)	N·m (lb in)
M4	3.8 (34)	5.5 (49)	4.2 (37)	6.1 (54)
M5	7.7 (68)	11 (97)	8.5 (75)	12 (106)
M6	13 (115)	18.7 (166)	14.3 (127)	20.6 (182)
M8	31.7 (281)	45.5 (403)	35 (310)	50 (443)
	N·m (lb ft)	N·m (lb ft)	N·m (lb ft)	N·m (lb ft)
M10	63 (47)	90 (66)	69 (51)	99 (73)
M12	110 (81)	157 (116)	121 (89)	173 (128)
M14	175 (129)	250 (184)	193 (142)	275 (202)
M16	272 (201)	389 (287)	299 (221)	428 (316)
M18	387 (286)	535 (395)	426 (315)	589 (435)
M20	550 (406)	759 (560)	605 (447)	835 (616)
M24	951 (702)	1315 (970)	1046 (772)	1447 (1067)

**Identification markings**

**Metric hex head, flange hex head and carriage bolts, Classes (CL) 5.6 and upward**

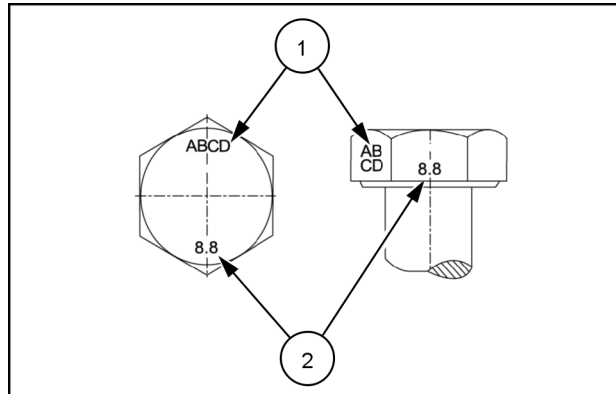

NHIL14RB00662AA 1

**Metric bolt identification markings**

1. Manufacturer's identification
2. Property class

**Metric hex nuts and locknuts, Classes (CL) 05 and upward**

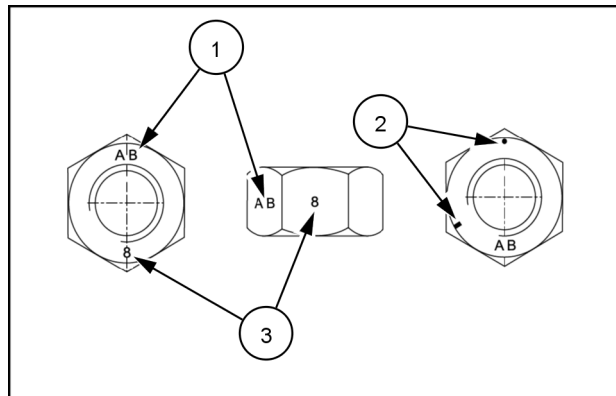

NHIL14RB00663AA 2

**Metric hex nut identification markings**

- (1) – Manufacturer's identification
- (3) – Property class
- (2) – Clockwise type markings indicate property class and may include manufacturer identification (if applied), Example: property marks **240°** apart (shown) at the eight o'clock position indicate a Class 8 property, and marks **300°** apart at the ten o'clock position indicate a Class 10 property.



**NOTE:** In the Imperial units tables, the nominal sizes, **1/4 (0.25) in (inch)** and **5/16 (0.3125) in (inch)** hardware torque specifications are shown as a Newton meters (pound-inches) numerical value.  
Nominal sizes **3/8 (0.375) in (inch)** through **1 (1.0) in (inch)** hardware torque specifications are shown as a Newton meters (pound-feet) numerical value.

### Inch hex head (non-flange) hardware

Plain (PLN) – an unplated hardware finish with residual manufacturing oils

Zinc-dichromate (ZND) – a yellow colored chemical plating formula yellow applied to the hardware

Nominal size	SAE Grade (GR) 5 bolt and nut	SAE Grade (GR) 8 bolt and nut	Locknut GR B w/ GR 5 bolt	Locknut GR C w/ GR 8 bolt
	PLN and ZND	PLN and ZND	ZND	ZND
	N·m (lb in)	N·m (lb in)	N·m (lb in)	N·m (lb in)
<b>1/4 (0.25) in</b>	13 (115)	18 (159)	7.2 (64)	10 (89)
<b>5/16 (0.3125) in</b>	27 (239)	38 (336)	14.9 (132)	21 (186)
	N·m (lb ft)	N·m (lb ft)	N·m (lb ft)	N·m (lb ft)
<b>3/8 (0.375) in</b>	47 (35)	67 (49)	26 (19)	37 (27)
<b>7/16 (0.4375) in</b>	76 (56)	107 (79)	42 (31)	59 (44)
<b>1/2 (0.50) in</b>	116 (85)	164 (121)	64 (47)	90 (67)
<b>9/16 (0.5625) in</b>	167 (123)	236 (174)	92 (68)	130 (96)
<b>5/8 (0.625) in</b>	231 (170)	326 (240)	127 (94)	179 (132)
<b>3/4 (0.75) in</b>	410 (302)	578 (426)	226 (166)	318 (234)
<b>7/8 (0.875) in</b>	660 (486)	931 (687)	363 (267)	512 (378)
<b>1 (1.0) in</b>	989 (729)	1396 (1030)	544 (401)	768 (567)

### Inch flange head hardware

Plain (PLN) – an unplated hardware finish with residual manufacturing oils









Zinc-dichromate (ZND) – a yellow colored chemical plating formula yellow applied to the hardware

Nominal size	SAE Grade (GR) 5 bolt and nut	SAE Grade (GR) 8 bolt and nut	Flange locknut GR F w/ GR 5 bolt	Flange locknut GR G w/ GR 8 bolt
	PLN and ZND	PLN and ZND	ZND	ZND
	N·m (lb in)	N·m (lb in)	N·m (lb in)	N·m (lb in)
<b>1/4 (0.25) in</b>	14 (124)	20 (177)	15.4 (136)	22 (195)
<b>5/16 (0.3125) in</b>	29 (257)	42 (372)	32 (283)	46 (407)
	N·m (lb ft)	N·m (lb ft)	N·m (lb ft)	N·m (lb ft)
<b>3/8 (0.375) in</b>	52 (38)	74 (54)	57 (42)	81 (9)
<b>7/16 (0.4375) in</b>	84 (62)	118 (87)	92 (68)	130 (96)
<b>1/2 (0.50) in</b>	127 (94)	180 (133)	140 (103)	198 (146)
<b>9/16 (0.5625) in</b>	184 (136)	259 (191)	202 (150)	285 (210)
<b>5/8 (0.625) in</b>	254 (187)	358 (264)	279 (206)	394 (290)
<b>3/4 (0.75) in</b>	450 (332)	636 (469)	495 (365)	700 (516)
<b>7/8 (0.875) in</b>	725 (535)	1024 (755)	798 (589)	1126 (831)
<b>1 (1.0) in</b>	1088 (802)	1536 (1133)	1197 (882)	1690 (1246)

**Identification marking**

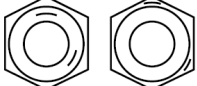
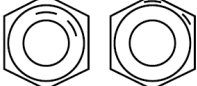
**Grades of inch bolts and free-spinning nuts**







**SAE (J995) bolt head and nut grade identification**

Grade identification marking	Grade Marking description
	<p><b>Grade 2</b> No line marks</p>
	<p><b>Grade 5</b> Three line marks</p>
	<p><b>Grade 8</b> Six line marks</p>
	<p><b>Grade 2</b> No circumferential line marks</p>
	<p><b>Grade 5</b> Two circumferential line marks located 120° apart</p>
	<p><b>Grade 2</b> Two circumferential line marks located 60° apart</p>
	<p><b>Grade 2</b> No circumferential line marks</p>
	<p><b>Grade 5</b> Two circumferential line marks located 120° apart</p>
	<p><b>Grade 8</b> Two circumferential line marks located 60° apart</p>

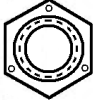
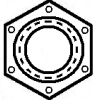
**Grades of inch prevailing torque locknuts, all metal (three common marking methods)**

On prevailing torque locknuts, the grade of nut is identified by one of three different sets of markings that denote the strength level and manufacturer.

**Common prevailing torque locknut grade identification markings**

Grade identification marking	Grade Marking description
	<p><b>Grade A</b> No marks</p>
	<p><b>Grade B (hex nut) and Grade F (flange nut)</b> Three raised or indented dot marks (Marks do not have to be in corners.)</p>
	<p><b>Grade C (hex nut) and Grade F (flange nut)</b> Six raised or indented dot marks (Marks do not have to be in corners.)</p>
	<p><b>Grade A</b> No letter mark on side flat</p>
	<p><b>Grade B</b> Letter B on side flat</p>
	<p><b>Grade C</b> Letter C on side flat</p>
	<p><b>Grade A</b> No notches</p>
	<p><b>Grade B</b> One circumferential notch on all six corners</p>
	<p><b>Grade C</b> Two circumferential notches on all six corners</p>

---

## Torque - Standard torque data for hydraulic connections

### General information

- Hydraulic connections require a minimum assembly torque in order to provide zero leakage at rated pressure with adequate fatigue resistance. Over-torquing of a hydraulic connection can also lead to leakage or failure. For some connections, CASE IH requires a different torque value than is listed in the ISO and SAE standards.
- The torque values in this document should be used whenever possible or applicable.

**NOTICE:** Always follow the instructions in this manual for specific torque values when you service components. The information in this section is for general guidance only when a procedure contains no specific torque value.

### Tolerance

- The tolerance for all torque values is  $\pm 10\%$ . This tolerance must include all assembly variation, not only the torque wrench repeatability.

### Lubrication

Application of grease or other lubricants to hydraulic connectors should be avoided. If clean hydraulic oil is already on the connection, it is not required to remove the oil. Generally, application of grease:

- May cause a significant change in the torque required to properly tighten the connection.
- May reduce the connection's resistance to vibration.
- Excessive grease may displace an elastomer seal during tightening.
- Grease extrusion when connection is tightened may be mistaken for leakage.

CASE IH products generally use O-Ring Boss (ORB) connectors that have Teflon™-coated O-rings, eliminating the need for O-ring lubrication during installation. For connections which are made into aluminum manifolds or with stainless steel connectors, it may be required to apply a lubricant to prevent galling.

Use of **LOCTITE®** and other thread-locking compounds is prohibited. These compounds:

- May cause a significant change in the torque required to properly tighten the connections.
- Reduce the serviceability of the joint.
- May prevent the O-ring from properly sealing if the compound gets on the O-ring.

Thank you so much for reading.  
Please click the “Buy Now!”  
button below to download the  
complete manual.



After you pay.

You can download the most  
perfect and complete manual in  
the world immediately.

Our support email:

[ebooklibonline@outlook.com](mailto:ebooklibonline@outlook.com)