

Operator's Manual

ZAXIS

135US-3 class

135US-3 · 135USK-3 · 135USL-3

225US-3 class

225US-3 · 225USLC-3

225USR-3 class

225USR-3 · 225USRLC-3 · 225USRK-3 · 225USRLCK-3

Hydraulic Excavator

Serial No.

ZX135US-3 class 080003 and up

ZX225US-3 class 200001 and up

ZX225USR-3 class 200001 and up

INDEX

MACHINE NUMBERS

SAFETY

SAFETY SIGNS

COMPONENTS NAME

OPERATOR'S STATION

BREAK-IN

OPERATING THE ENGINE

DRIVING THE MACHINE

OPERATING THE MACHINE

TRANSPORTING

MAINTENANCE

MAINTENANCE UNDER SPECIAL ENVIRONMENTAL CONDITIONS

STORAGE

TROUBLESHOOTING

SPECIFICATIONS

OPTIONAL ATTACHMENTS AND DEVICES

INDEX

MACHINE NUMBERS

TRAVEL MOTOR

TYPE: _____

MFG. NO.: _____

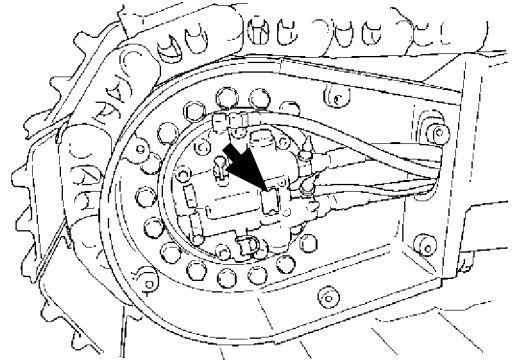

M178-07-047

SWING MOTOR

TYPE: _____

MFG. NO.: _____

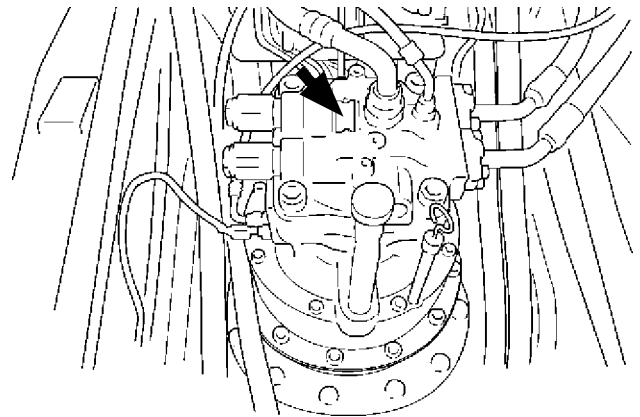

M178-07-086

HYDRAULIC PUMP (ZX135US-3 class)

TYPE: _____

MFG. NO.: _____

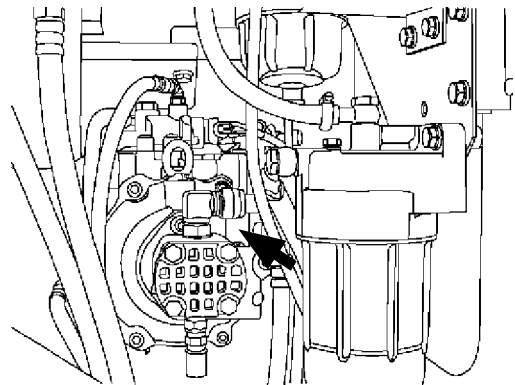

M1U4-00-001

(ZX225US-3 • 225USR-3 class)

TYPE: _____

MFG. NO.: _____

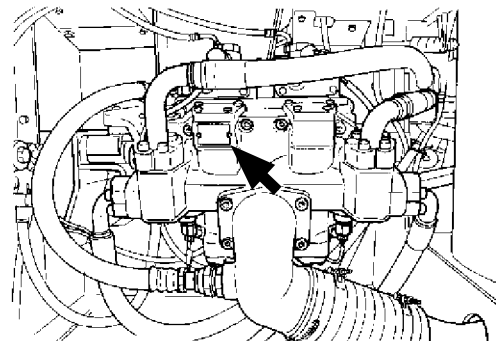

M157-00-004

CONTENTS

MACHINE NUMBERS

SAFETY

Recognize Safety Information	S-1
Understand Signal Words	S-1
Follow Safety Instructions	S-2
Prepare for Emergencies	S-2
Wear Protective Clothing	S-3
Protect Against Noise	S-3
Inspect Machine	S-3
General Precautions for Cab	S-4
Use Handholds and Steps	S-5
Adjust the Operator's Seat	S-5
Ensure Safety Before Rising From or Leaving Operator's Seat	S-5
Fasten Your Seat Belt	S-6
Move and Operate Machine Safely	S-6
Handle Starting Aids Safely	S-6
Operate Only From Operator's Seat	S-7
Jump Starting	S-7
Keep Riders Off Machine	S-7
Precautions for Operations	S-8
Investigate Job Site Beforehand	S-9
Equipment of Head Guard, Rops, Fops	S-10
Provide Signals for Jobs Involving Multiple Numbers of Machines	S-10
Confirm Direction of Machine to Be Driven	S-10
Drive Machine Safely	S-11
Avoid Injury From Rollaway Accidents	S-13
Avoid Injury From Back-over and Swing Accidents	S-14
Keep Person Clear From Working Area	S-15
Never Position Bucket Over Anyone	S-15
Avoid Undercutting	S-15
Avoid Tipping	S-16
Never Undercut a High Bank	S-16
Dig with Caution	S-17
Operate with Caution	S-17
Avoid Power Lines	S-18
Precautions for Lightning	S-18
Object Handling	S-18
Protect Against Flying Debris	S-19
Park Machine Safely	S-19
Handle Fluids Safely—Avoid Fires	S-19
Transport Safely	S-20
Practice Safe Maintenance	S-21
Warn Others of Service Work	S-22
Support Machine Properly	S-22
Stay Clear of Moving Parts	S-22
Prevent Parts From Flying	S-23
Store Attachments Safely	S-23
Prevent Burns	S-24
Replace Rubber Hoses Periodically	S-24
Avoid High-pressure Fluids	S-25
Prevent Fires	S-26
Evacuating in Case of Fire	S-27

Beware of Exhaust Fumes	S-27
Precautions for Welding and Grinding	S-27
Avoid Heating Near Pressurized Fluid Lines	S-28
Avoid Applying Heat to Lines Containing Flammable Fluids	S-28
Remove Paint Before Welding or Heating	S-28
Beware of Asbestos Dust	S-29
Prevent Battery Explosions	S-29
Service Air Conditioning System Safely	S-29
Handle Chemical Products Safely	S-30
Dispose of Waste Properly	S-30

SAFETY SIGNS/Oceania Model Only

S-31

SAFETY SIGNS/Asia/Middle and Near East Model Only

S-37

COMPONENTS NAME

1-1

OPERATOR'S STATION

Cab Features	1-2
Multi Function Monitor	1-4
Outline	1-5
Menu Screen (23)	1-8
Hour Meter	1-9
Fuel Gauge	1-9
Clock	1-9
Back Monitor Selector	1-9
Menu Key	1-10
Optional Function Key	1-10
Return to Basic Screen Key	1-10
Alarm Light	1-10
Optional Function Display	1-10
Coolant Temperature Gauge	1-11
Operating Status Icon Display	1-11
Alarm Occurrence Screen	1-16
Contents of Alarms	1-18
Clock Setting	1-20
Attachment Selection (Only Machines Equipped with Optional Parts)	1-21
Selecting an Attachment from Main Menu	1-22
Attachment Specification Screen	1-23
Pump 2 Flow Rate Adjustment (Only Machines Equipped with Optional Parts)	1-25
Displaying Operating Conditions	1-26
Fuel Rate Display/No Display	1-27
Back Monitor Settings	1-35
Maintenance Settings	1-37
Mail (Optional)	1-42
Language Settings	1-44
Switch Panel	1-46
Engine Control Dial	1-47
Auto-idle Switch	1-47
Power Mode Switch	1-48
Travel Mode Switch	1-48

CONTENTS

Layout.....	7-3	Replace Batteries	7-64
Maintenance Guide Table.....	7-4	Remove and Installing Battery	7-65
Prepare Machine for Maintenance.....	7-6	Replacing Fuses.....	7-65
Hood and Access Covers.....	7-7	I. Miscellaneous	7-67
Periodic Replacement of Parts.....	7-8	Check Bucket Teeth.....	7-67
Maintenance Guide	7-9	Change Bucket	7-71
A. Greasing.....	7-14	Convert Bucket Connection Into Face Shovel.....	7-72
Front Joint Pins.....	7-14	Adjust Bucket Linkage.....	7-73
Swing Bearing.....	7-16	Remove Travel Levers.....	7-74
Swing Internal Gear	7-17	Check and Replace Seat Belt	7-74
B. Engine.....	7-18	Check Windshield Washer Fluid Level.....	7-75
Engine Oil Level.....	7-18	Check Track Sag.....	7-76
Change Engine Oil	7-19	Clean and Replace Air Conditioner Filter	7-78
Replace Engine Oil Filter	7-19	Check Air Conditioner.....	7-81
C. Transmission.....	7-21	Clean Cab Floor	7-82
Pump Transmission.....	7-21	Retighten Cylinder Head Bolt.....	7-83
Swing Reduction Gear.....	7-22	Inspect and Adjust Valve Clearance.....	7-83
Travel Reduction Gear.....	7-23	Measure Engine Compression Pressure	7-83
D. Hydraulic System.....	7-25	Check Starter and Alternator.....	7-83
Inspection and Maintenance of		Check and Replace EGR Device	7-83
Hydraulic Equipment	7-25	Check Tightening Torque of Bolts and Nuts	7-84
Breaker Maintenance	7-27	MAINTENANCE UNDER SPECIAL	
Check Hydraulic Oil Level.....	7-28	ENVIRONMENTAL CONDITIONS	
Change Hydraulic Oil	7-29	Maintenance Under Special Environmental	
Suction Filter Cleaning	7-29	Conditions	9-1
Replace Hydraulic Tank Oil Filter	7-32	STORAGE	
Replace Hydraulic Tank Oil Filter		Storing the Machine.....	10-1
(K Model, L Model).....	7-33	Removing the Machine from Storage.....	10-2
Replace Pilot Oil Filter	7-34	TROUBLESHOOTING	
Replace Air Breather Element	7-35	Impossible to Start the Engine	11-1
Check Hoses and Lines.....	7-36	Engine.....	11-2
Service Recommendations for Hydraulic Fittings	7-39	Electrical System.....	11-6
E. Fuel System.....	7-41	Mode Selection	11-8
Drain Fuel Tank Sump	7-43	Control Levers.....	11-9
Drain Fuel Filter	7-44	Hydraulic System.....	11-9
Replace Fuel Main Filter Element.....	7-48	SPECIFICATIONS	
Replace Fuel Pre-Filter Element	7-49	Specifications (ZX135US-3).....	12-1
Clean Fuel Solenoid Pump Strainer	7-50	Working Ranges (ZX135US-3).....	12-2
Check Fuel Hoses.....	7-51	Shoe Types and Applications (ZX135US-3)	12-3
F. Air Cleaner.....	7-52	Bucket Types and Applications (ZX135US-3)	12-4
Clean Air Cleaner Outer Element.....	7-52	Specifications (ZX135USK-3).....	12-5
Replace Air Cleaner Outer and Inner Elements	7-52	Working Ranges (ZX135USK-3)	12-6
G. Cooling System	7-54	Shoe Types and Applications (ZX135USK-3)	12-7
Check Coolant Level	7-56	Bucket Types and Applications (ZX135USK-3).....	12-8
Check and Adjust Fan Belt Tension	7-57	Specifications (ZX135USL-3).....	12-9
Change Coolant	7-59	Working Ranges (ZX135USL-3).....	12-10
Clean Radiator Interior.....	7-59	Shoe Types and Applications (ZX135USL-3).....	12-11
Clean Radiator, Oil Cooler Core		Bucket Types and Applications (ZX135USL-3)	12-12
and Inter Cooler Outside.....	7-60	Specifications (ZX225US-3, 225USLC-3).....	12-13
Clean Oil Cooler, Radiator and Inter		Working Ranges (ZX225US-3, 225USLC-3).....	12-14
Cooler Front Screen	7-60		
Clean Air Conditioner Condenser.....	7-60		
Clean Fuel Oil Cooler	7-60		
Clean Air Conditioner Front Screen (Opt.).....	7-60		
H. Electrical System.....	7-61		

CONTENTS

Shoe Types and Applications (ZX225US-3, 225USLC-3).....	12-15
Bucket Types and Applications (ZX225US-3, 225USLC-3).....	12-16
Specifications (ZX225USR-3, 225USRLC-3, 225USRK-3, 225USRLCK-3)	12-17
Working Ranges (ZX225USR-3, 225USRLC-3, 225USRK-3, 225USRLCK-3)	12-18
Shoe Types and Applications (ZX225USR-3, 225USRLC-3).....	12-19
(ZX225USRK-3, 225USRLCK-3).....	12-20
Bucket Types and Applications (ZX225USR-3, 225USRLC-3).....	12-21
(ZX225USRK-3, 225USRLCK-3).....	12-22

OPTIONAL ATTACHMENTS AND DEVICES

Bucket Teeth (Transverse-Type-Pin-Used Type)	13-1
Using Pad Crawler Shoe	13-2
Traveling and Other Cautions	13-3
Transporting.....	13-4
Precautions for Transporting Machines with Pad Crawler Shoes.....	13-4
Long Arm Operation --- If Equipped.....	13-7
Blade Lever	13-8
Precautions for Blade Operation.....	13-8
Avoid Hitting Blade with Front-end Attachment.....	13-9
Avoid Hitting Blade with Bucket.....	13-9
Avoid Striking The Blade Into a Rock.....	13-9
Blade Maintenance	13-10
Specifications (ZX135US-3 with Blade)	13-11
Working Ranges (ZX135US-3 with Blade)	13-12
Shoe Types and Applications (ZX135US-3 with Blade)	13-13
Specifications (ZX135USL-3 with Blade)	13-14
Working Ranges (ZX135USL-3 with Blade)	13-15
Shoe Types and Applications (ZX135USL-3 with Blade)	13-16
INDEX	14-1

SAFETY

RECOGNIZE SAFETY INFORMATION

- These are the **SAFETY ALERT SYMBOLS**.
 - When you see these symbols on your machine or in this manual, be alert to the potential for personal injury.
 - Follow recommended precautions and safe operating practices.



001-E01A-0001

SA-038

UNDERSTAND SIGNAL WORDS

- On machine safety signs, signal words designating the degree or level of hazard - **DANGER**, **WARNING**, or **CAUTION** - are used with the safety alert symbol.
 - **DANGER** indicates an imminently hazardous situation which, if not avoided, will result in death or serious injury.
 - **WARNING** indicates a potentially hazardous situation which, if not avoided, could result in death or serious injury.
 - **CAUTION** indicates a potentially hazardous situation which, if not avoided, may result in minor or moderate injury.
 - **DANGER or WARNING safety signs** are located near specific hazards. General precautions are listed on **CAUTION safety signs**.
 - Some safety signs don't use any of the designated signal words above after the safety alert symbol are occasionally used on this machine.
- To avoid confusing machine protection with personal safety messages, a signal word **IMPORTANT** indicates a situation which, if not avoided, could result in damage to the machine.
-  **NOTE** indicates an additional explanation for an element of information.



IMPORTANT



SA-1223

002-E01A-1223

SAFETY

FOLLOW SAFETY INSTRUCTIONS

- Carefully read and follow all safety signs on the machine and all safety messages in this manual.
- Safety signs should be installed, maintained and replaced when necessary.
 - If a safety sign or this manual is damaged or missing, order a replacement from your authorized dealer in the same way you order other replacement parts (be sure to state machine model and serial number when ordering).
- Learn how to operate the machine and its controls correctly and safely.
- Allow only trained, qualified, authorized personnel to operate the machine.
- Keep your machine in proper working condition.
 - Unauthorized modifications of the machine may impair its function and/or safety and affect machine life.
 - Do not modify any machine parts without authorization. Failure to do so may deteriorate the part safety, function, and/or service life. In addition, personal accident, machine trouble, and/or damage to material caused by unauthorized modifications will void Hitachi Warranty Policy.
 - Do not use attachments and/or optional parts or equipment not authorized by Hitachi. Failure to do so may deteriorate the safety, function, and/or service life of the machine. In addition, personal accident, machine trouble, and/or damage to material caused by using unauthorized attachments and/or optional parts or equipment will void Hitachi Warranty Policy.
- The safety messages in this SAFETY chapter are intended to illustrate basic safety procedures of machines. However it is impossible for these safety messages to cover every hazardous situation you may encounter. If you have any questions, you should first consult your supervisor and/or your authorized dealer before operating or performing maintenance work on the machine.

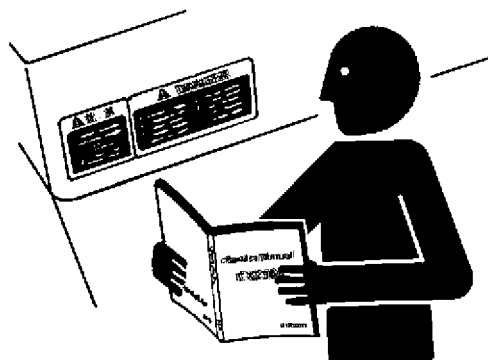

SA-003

003-E01B-0003

PREPARE FOR EMERGENCIES

- Be prepared if a fire starts or if an accident occurs.
 - Keep a first aid kit and fire extinguisher on hand.
 - Thoroughly read and understand the label attached on the fire extinguisher to use it properly.
 - To ensure that a fire extinguisher can be always used when necessary, check and service the fire extinguisher at the recommended intervals as specified in the fire extinguisher manual.
 - Establish emergency procedure guidelines to cope with fires and accidents.
 - Keep emergency numbers for doctors, ambulance service, hospital, and fire department posted near your telephone.

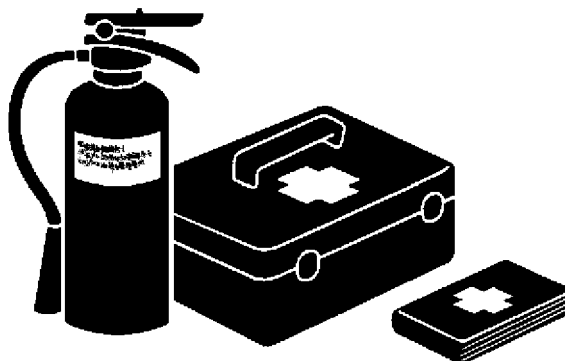

SA-437

004-E01A-0437

SAFETY

WEAR PROTECTIVE CLOTHING

- Wear close fitting clothing and safety equipment appropriate to the job.

You may need:

- A hard hat
- Safety shoes
- Safety glasses, goggles, or face shield
- Heavy gloves
- Hearing protection
- Reflective clothing
- Wet weather gear
- Respirator or filter mask.

Be sure to wear the correct equipment and clothing for the job. Do not take any chances.

- Avoid wearing loose clothing, jewelry, or other items that can catch on control levers or other parts of the machine.
- Operating equipment safely requires the full attention of the operator. Do not wear radio or music headphones while operating the machine.

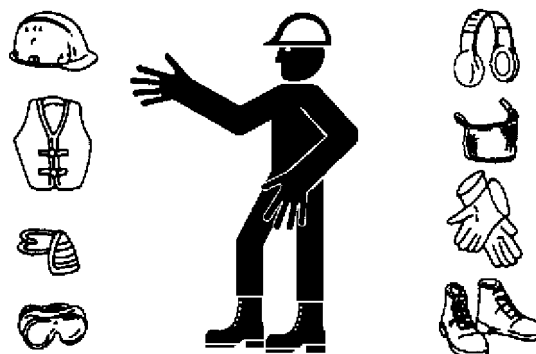

SA-438

005-E01A-0438

PROTECT AGAINST NOISE

- Prolonged exposure to loud noise can cause impairment or loss of hearing.
- Wear a suitable hearing protective device such as earmuffs or earplugs to protect against objectionable or uncomfortably loud noises.



006-E01A-0434

SA-434

INSPECT MACHINE

- Inspect your machine carefully each day or shift by walking around it before you start it to avoid personal injury.
- In the walk-around inspection be sure to cover all points described in the "PRE-START INSPECTION" chapter in the operator's manual.



007-E01A-0435

SA-435

SAFETY

GENERAL PRECAUTIONS FOR CAB

- Before entering the cab, thoroughly remove all dirt and/or oil from the soles of your work boots. If any controls such as a pedal is operated while with dirt and/or oil on the soles of the operator's work boots the operator's foot may slip off the pedal, possibly resulting in a personal accident.
- Do not leave parts and/or tools lying around the operator's seat. Store them in their specified locations.
- Avoid storing transparent bottles in the cab. Do not attach any transparent type window decorations on the windowpanes as they may focus sunlight, possibly starting a fire.
- Refrain from listening to the radio, or using music headphones or mobile telephones in the cab while operating the machine.
- Keep all flammable objects and/or explosives away from the machine.
- After using the ashtray, always cover it to extinguish the match and/or tobacco.
- Do not leave cigarette lighters in the cab. When the temperature in the cab increases, the lighter may explode.

524-E01A-0000

SAFETY

USE HANDHOLDS AND STEPS

- Falling is one of the major causes of personal injury.
 - When you get on and off the machine, always face the machine and maintain a three-point contact with the steps and handrails.
 - Do not use any controls as hand-holds.
 - Never jump on or off the machine. Never mount or dismount a moving machine.
 - Be careful of slippery conditions on platforms, steps, and handrails when leaving the machine.

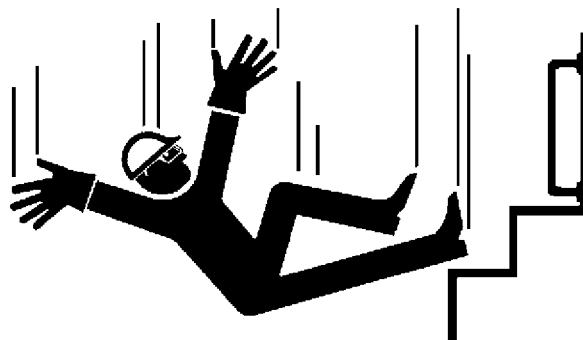

008-E01A-0439

SA-439

ADJUST THE OPERATOR'S SEAT

- A poorly adjusted seat for either the operator or for the work at hand may quickly fatigue the operator leading to misoperations.
 - The seat should be adjusted whenever changing the operator for the machine.
 - The operator should be able to fully depress the pedals and to correctly operate the control levers with his back against the seat back.
 - If not, move the seat forward or backward, and check again.
 - Adjust the rear view mirror position so that the best rear visibility is obtained from the operator's seat. If the mirror is broken, immediately replace it with a new one.

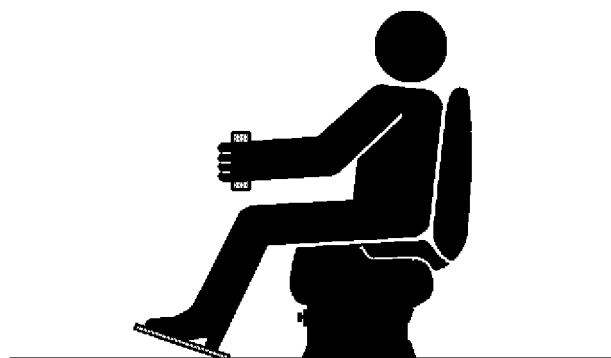

SA-378

009-E01A-0462

ENSURE SAFETY BEFORE RISING FROM OR LEAVING OPERATOR'S SEAT

- Before rising from the operator's seat to open/close either side window or to adjust the seat position, be sure to first lower the front attachment to the ground and then move the pilot control shut-off lever to the LOCK position. Failure to do so may allow the machine to unexpectedly move when a body part unintentionally comes in contact with a control lever, possibly resulting in serious personal injury or death.
 - Before leaving the machine, be sure to first lower the front attachment to the ground and then move the pilot control shut-off lever to the LOCK position. Turn the key switch OFF to stop the engine.
 - Before leaving the machine, close all windows, doors, and access covers and lock them up.

SAFETY

FASTEN YOUR SEAT BELT

- If the machine should overturn, the operator may become injured and/or thrown from the cab. Additionally the operator may be crushed by the overturning machine, resulting in serious injury or death.
- Prior to operating the machine, thoroughly examine webbing, buckle and attaching hardware. If any item is damaged or worn, replace the seat belt or component before operating the machine.
- Be sure to remain seated with the seat belt securely fastened at all times when the machine is in operation to minimize the chance of injury from an accident.
- We recommend that the seat belt be replaced every three years regardless of its apparent condition.

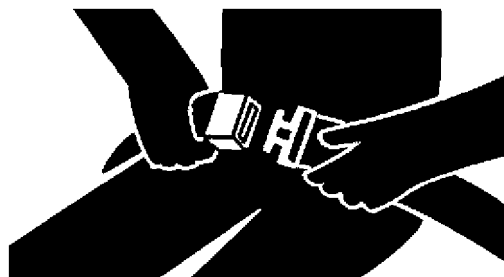

SA-237

010-E01A-0237

MOVE AND OPERATE MACHINE SAFELY

- Bystanders can be run over.
- Take extra care not to run over bystanders. Confirm the location of bystanders before moving, swinging, or operating the machine.
- Always keep the travel alarm and horn in working condition (if equipped). It warns people when the machine starts to move.
- Use a signal person when moving, swinging, or operating the machine in congested areas. Coordinate hand signals before starting the machine.
- Use appropriate illumination. Check that all lights are operable before operating the machine. If any faulty illumination is present, immediately repair it.

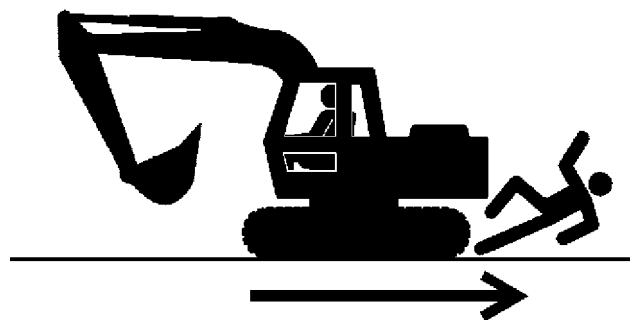

SA-426

011-E01A-0398

HANDLE STARTING AIDS SAFELY

Starting fluid:

- Starting fluid is highly flammable.
- Keep all sparks and flame away when using it.
- Keep starting fluid well away from batteries and cables.
- Remove container from machine if engine does not need starting fluid.
- To prevent accidental discharge when storing a pressurized container, keep the cap on the container, and store it in a cool, well-protected location.
- Do not incinerate or puncture a starting fluid container.

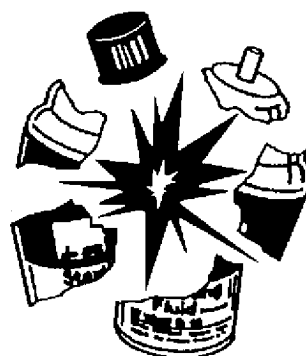

SA-293

036-E01A-0293-3

SAFETY

OPERATE ONLY FROM OPERATOR'S SEAT

- Inappropriate engine starting procedures may cause the machine to runaway, possibly resulting in serious injury or death.
 - Start the engine only when seated in the operator's seat.
 - NEVER start the engine while standing on the track or on ground.
 - Do not start engine by shorting across starter terminals.
 - Before starting the engine, confirm that all control levers are in neutral.
 - Before starting the engine, confirm the safety around the machine and sound the horn to alert bystanders.



012-E01B-0431

SA-444

JUMP STARTING

- Battery gas can explode, resulting in serious injury.
 - If the engine must be jump started, be sure to follow the instructions shown in the "OPERATING THE ENGINE" chapter in the operator's manual.
 - The operator must be in the operator's seat so that the machine will be under control when the engine starts. Jump starting is a two-person operation.
 - Never use a frozen battery.
 - Failure to follow correct jump starting procedures could result in a battery explosion or a runaway machine.

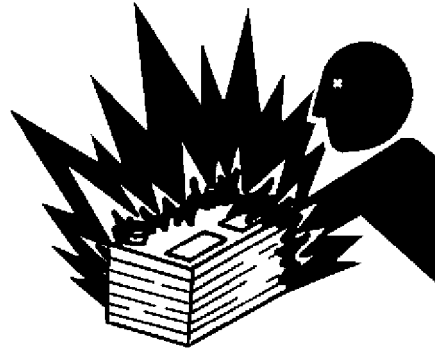

S013-E01A-0032

SA-032

KEEP RIDERS OFF MACHINE

- Riders on machine are subject to injury such as being struck by foreign objects and being thrown off the machine.
 - Only the operator should be on the machine. Keep riders off.
 - Riders also obstruct the operator's view, resulting in the machine being operated in an unsafe manner.

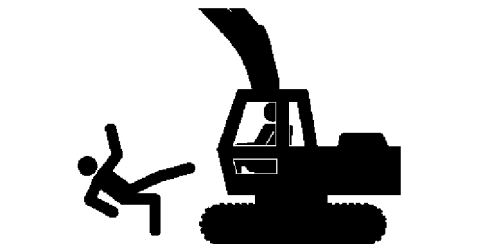

014-E01B-0427

SA-379

SAFETY

PRECAUTIONS FOR OPERATIONS

- Investigate the work site before starting operations.
 - Be sure to wear close fitting clothing and safety equipment appropriate for the job, such as a hard hat, etc. when operating the machine.
 - Clear all persons and obstacles from area of operation and machine movement.
Always beware of the surroundings while operating.
When working in a small area surrounded by obstacles, take care not to hit the upperstructure against obstacles.
- When loading onto trucks, bring the bucket over the truck beds from the rear side. Take care not to swing the bucket over the cab or over any person.

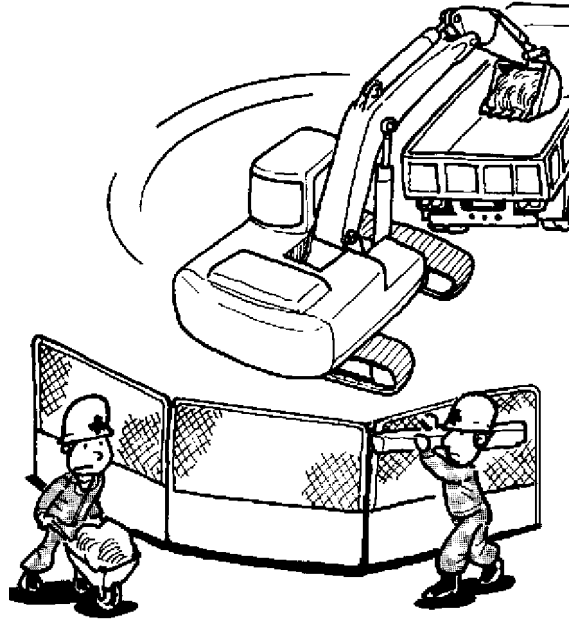

M178-05-007

SAFETY

INVESTIGATE JOB SITE BEFOREHAND

- When working at the edge of an excavation or on a road shoulder, the machine could tip over, possibly resulting in serious injury or death.
 - Investigate the configuration and ground conditions of the job site beforehand to prevent the machine from falling and to prevent the ground, stockpiles, or banks from collapsing.
 - Make a work plan. Use machines appropriate to the work and job site.
 - Reinforce ground, edges, and road shoulders as necessary. Keep the machine well back from the edges of excavations and road shoulders.
 - When working on an incline or on a road shoulder, employ a signal person as required.
 - Confirm that your machine is equipped a FOPS cab before working in areas where the possibility of falling stones or debris exist.
 - When the footing is weak, reinforce the ground before starting work.
 - When working on frozen ground, be extremely alert. As ambient temperatures rise, footing becomes loose and slippery.
 - Beware the possibility of fire when operating the machine near flammable objects such as dry grass.
- Make sure the worksite has sufficient strength to firmly support the machine.
When working close to an excavation or at road shoulders, operate the machine with the tracks positioned perpendicular to the cliff face with travel motors at the rear, so that the machine can more easily evacuate if the cliff face collapses.
- If working on the bottom of a cliff or a high bank is required, be sure to investigate the area first and confirm that no danger of the cliff or bank collapsing exists. If any possibility of cliff or bank collapsing exists, do not work on the area.
- Soft ground may collapse when operating the machine on it, possibly causing the machine to tip over. When working on soft ground is required, be sure to reinforce the ground first using large pieces of steel plates strong and firm enough to easily support the machine.
- Note that there is always a possibility of machine tipping over when working on rough terrain or on slopes. Prevent machine tipping over from occurring. When operating on rough terrain or on slopes:
 - Reduce the engine speed.
 - Select slow travel speed mode.
 - Operate the machine slowly and be cautious with machine movements.

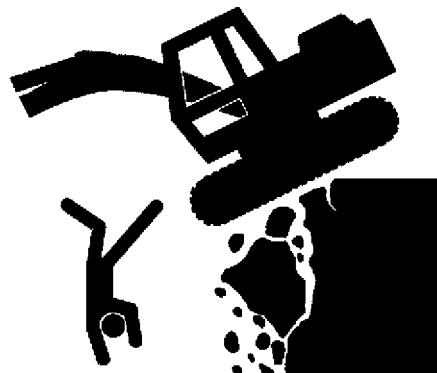

SA-380

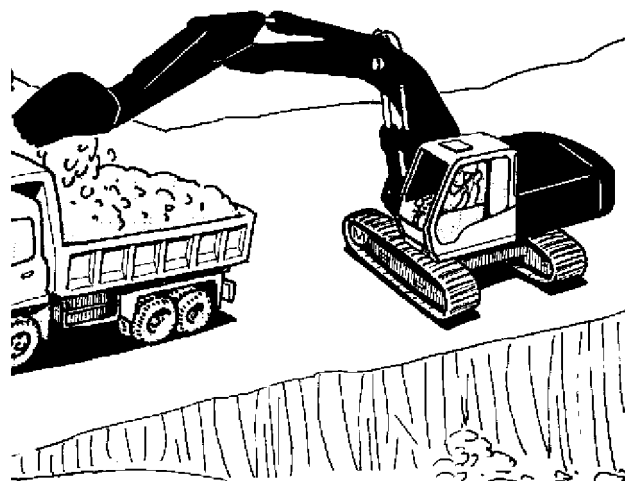

M104-05-016

SAFETY

EQUIPMENT OF HEAD GUARD, ROPS, FOPS

In case the machine is operated in areas where the possibility of falling stones or debris exist, equip a head guard, ROPS, or FOPS according to the potential hazardous conditions. (The standard cab for this machine corresponds to ROPS and FOPS.)

ROPS: Roll-Over Protective Structure
FOPS: Falling Object Protective Structure

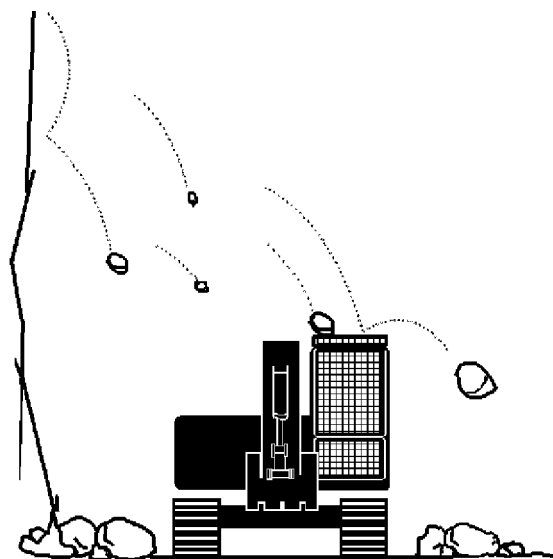

SA-490

PROVIDE SIGNALS FOR JOBS INVOLVING MULTIPLE NUMBERS OF MACHINES

- For jobs involving multiple numbers of machines, provide signals commonly known by all personnel involved. Also, appoint a signal person to coordinate the job site. Make sure that all personnel obey the signal person's directions.



018-E01A-0481

SA-481

CONFIRM DIRECTION OF MACHINE TO BE DRIVEN

- Incorrect travel pedal/lever operation may result in serious injury death.
- Before driving the machine, confirm the position of the undercarriage in relation to the operator's position. If the travel motors are located in front of the cab, the machine will move in reverse when travel pedals/levers are operated to the front.

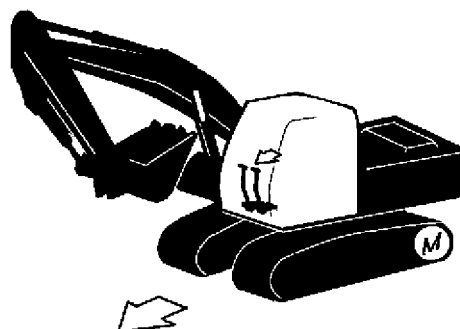

017-E01A-0491

SA-491

SAFETY

DRIVE MACHINE SAFELY

- Before driving the machine, always confirm that the travel levers/pedals direction corresponds to the direction you wish to drive.
 - Be sure to detour around any obstructions.
 - Avoid traveling over obstructions. Soil, fragments of rocks, and/or metal pieces may scatter around the machine. Do not allow personnel to stay around the machine while traveling.
- Driving on a slope may cause the machine to slip or overturn, possibly resulting in serious injury or death.
 - Never attempt to ascend or descend 35 degrees or steeper slopes.
 - Be sure to fasten the seat belt.
 - When driving up or down a slope, keep the bucket facing the direction of travel, approximately 0.5 to 1.0 m (A) above the ground.
 - If the machine starts to skid or becomes unstable, immediately lower the bucket to the ground and stop.

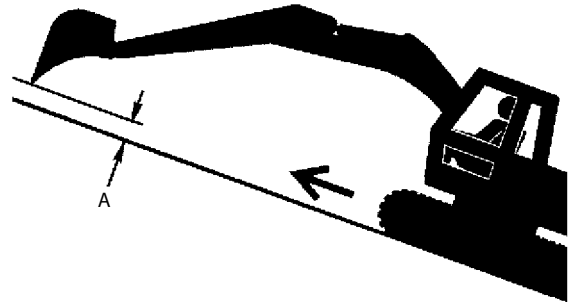

SA-657

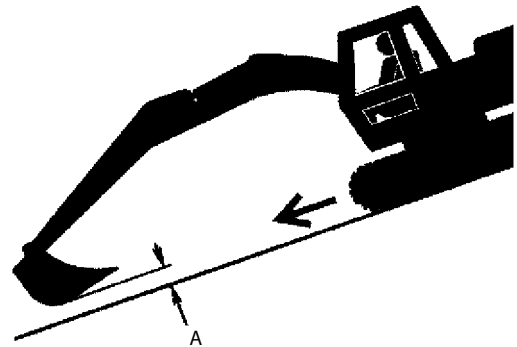

SA-658

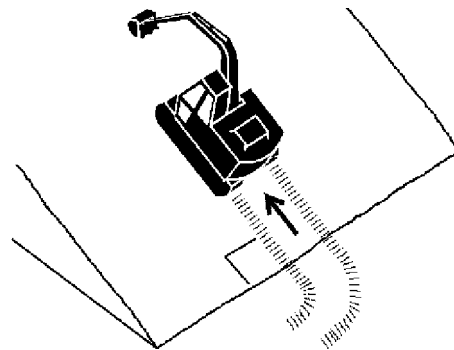

SA-441

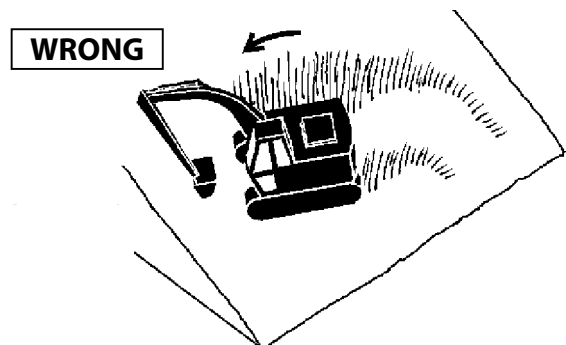

SA-442

SAFETY

- Driving across the face of a slope or steering on a slope may cause the machine to skid or turnover. If the direction must be changed, move the machine to level ground, then, change the direction to ensure safe operation.
- Avoid swinging the upperstructure on slopes. Never attempt to swing the upperstructure downhill. The machine may tip over. If swinging uphill is unavoidable, carefully operate the upperstructure and boom at slow speed.
- If the engine stalls on a slope, immediately lower the bucket to the ground. Return the control levers to neutral. Then, restart the engine.
- Be sure to thoroughly warm up the machine before ascending steep slopes. If hydraulic oil has not warmed up sufficiently, sufficient performance may not be obtained.
- Use a signal person when moving, swinging or operating the machine in congested areas. Coordinate hand signals before starting the machine.
- Before moving machine, determine which way to move travel pedals/levers for the direction you want to go. When the travel motors are in the rear, pushing down on the front of the travel pedals or pushing the levers forward moves the machine forward, towards the idlers. An arrow-mark seal is stuck on the inside surface of the side frame to indicate the machine front direction.
- Select a travel route that is as flat as possible. Steer the machine as straight as possible, making small gradual changes in direction.
- Before traveling on them, check the strengths of bridges and road shoulders, and reinforce if necessary.
- Use wood plates in order not to damage the road surface. Be careful of steering when operating on asphalt roads in summer.
- When crossing train tracks, use wood plates in order not to damage them.
- Do not make contact with electric wires or bridges.
- When crossing a river, measure the depth of the river using the bucket, and cross slowly. Do not cross the river when the depth of the river is deeper than the upper edge of the upper roller.
- When traveling on rough terrain, reduce engine speed. Select slow travel speed. Slower speed will reduce possible damage to the machine.
- Avoid operations that may damage the track and undercarriage components.
- During freezing weather, always clean snow and ice from track shoes before loading and unloading machine, to prevent the machine from slipping.

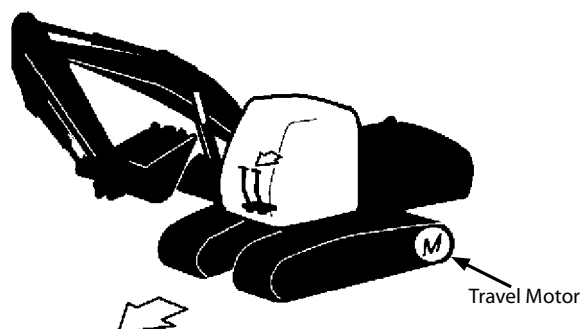

M104-05-008

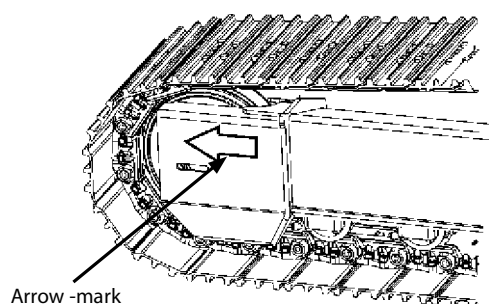

M178-03-001

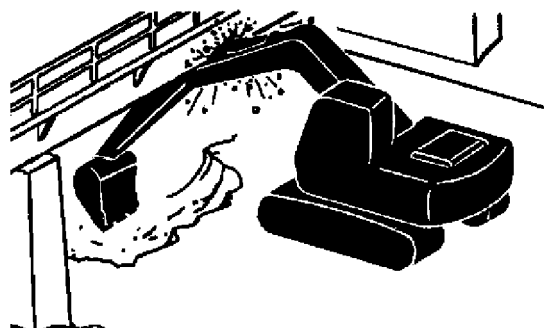

SA-011

SAFETY

AVOID INJURY FROM ROLLAWAY ACCIDENTS

- Death or serious injury may result if you attempt to mount or stop a moving machine.

To avoid rollaways:

- Select level ground when possible to park machine.
- Do not park the machine on a grade.
- Lower the bucket and/or other work tools to the ground.
- Turn the auto-idle switch and the H/P mode switch off.
- Run the engine at slow idle speed without load for 5 minutes to cool down the engine.
- Stop the engine and remove the key from the key switch.
- Pull the pilot control shut-off lever to LOCK position.
- Block both tracks and lower the bucket to the ground. Thrust the bucket teeth into the ground if you must park on a grade.
- Position the machine to prevent rolling.
- Park a reasonable distance from other machines.

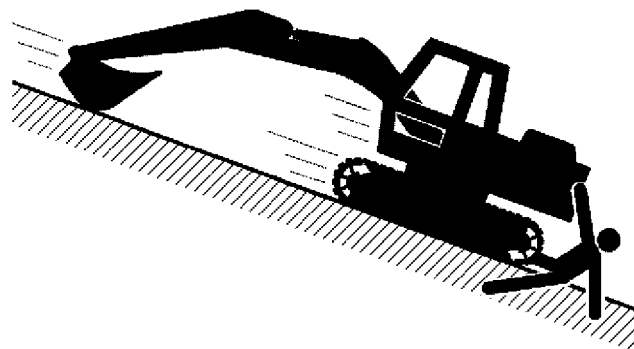

SA-391

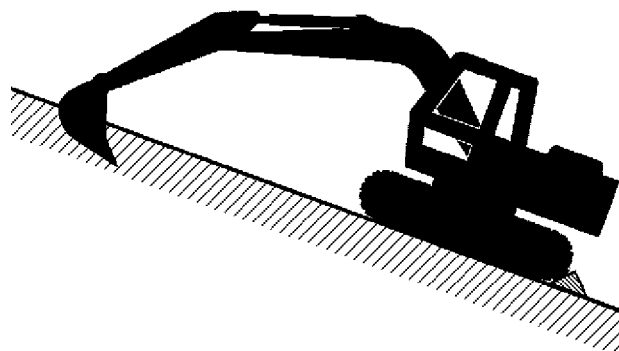

SA-392

020-E02A-0493

SAFETY

AVOID INJURY FROM BACK-OVER AND SWING ACCIDENTS

- If any person is present near the machine when backing or swinging the upperstructure, the machine may hit or run over that person, resulting in serious injury or death.

To avoid back-over and swing accidents:

- Always look around **BEFORE YOU BACK UP AND SWING THE MACHINE**. BE SURE THAT ALL BYSTANDERS ARE CLEAR.
- Keep the travel alarm in working condition (if equipped). ALWAYS BE ALERT FOR BYSTANDERS MOVING INTO THE WORK AREA. USE THE HORN OR OTHER SIGNAL TO WARN BYSTANDERS BEFORE MOVING MACHINE.
- USE A SIGNAL PERSON WHEN BACKING UP IF YOUR VIEW IS OBSTRUCTED. ALWAYS KEEP THE SIGNAL PERSON IN VIEW.
Use hand signals, which conform to your local regulations, when work conditions require a signal person.
- No machine motions shall be made unless signals are clearly understood by both signalman and operator.
- Learn the meanings of all flags, signs, and markings used on the job and confirm who has the responsibility for signaling.
- Keep windows, mirrors, and lights clean and in good condition.
- Dust, heavy rain, fog, etc., can reduce visibility. As visibility decreases, reduce speed and use proper lighting.
- Read and understand all operating instructions in the operator's manual.

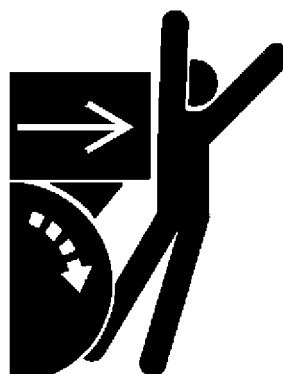

SA-383

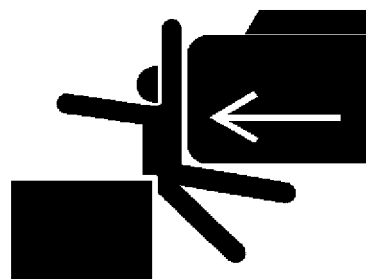

SA-384

021-E01A-0494

SAFETY

KEEP PERSON CLEAR FROM WORKING AREA

- A person may be hit severely by the swinging front attachment or counterweight and/or may be crushed against another object, resulting in serious injury or death.
- Keep all persons clear from the area of operation and machine movement.
- Before operating the machine, set up barriers to the sides and rear area of the bucket swing radius to prevent anyone from entering the work area.

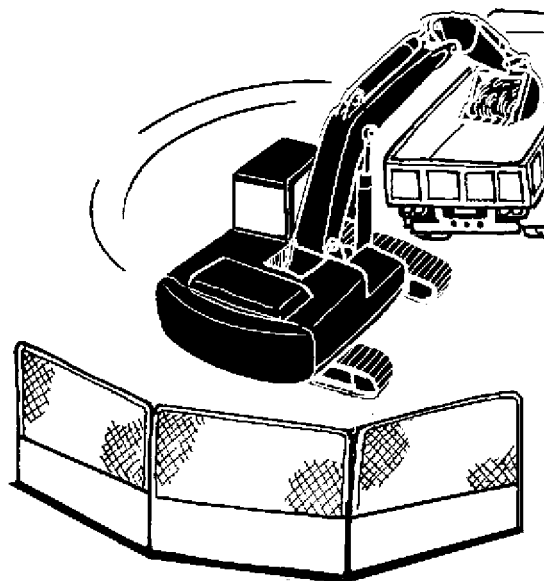

022-E01A-0386

SA-386

NEVER POSITION BUCKET OVER ANYONE

- Never lift, move, or swing bucket above anyone or a truck cab. Serious injury or machine damage may result due to bucket load spill or due to collision with the bucket.



023-E01A-0487

SA-487

AVOID UNDERCUTTING

- In order to retreat from the edge of an excavation if the footing should collapse, always position the undercarriage perpendicular to the edge of the excavation with the travel motors at the rear.
- If the footing starts to collapse and if retreat is not possible, do not panic. Often, the machine can be secured by lowering the front attachment, in such cases.

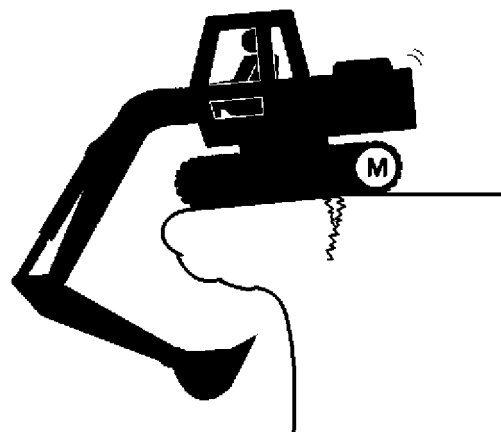

024-E01A-0488

SA-488

SAFETY

AVOID TIPPING

DO NOT ATTEMPT TO JUMP CLEAR OF TIPPING MACHINE---SERIOUS OR FATAL CRUSHING INJURIES WILL RESULT

MACHINE WILL TIP OVER FASTER THAN YOU CAN JUMP FREE

FASTEN YOUR SEAT BELT

- The danger of tipping is always present when operating on a grade, possibly resulting in serious injury or death.

To avoid tipping:

- Be extra careful before operating on a grade.
 - Prepare machine operating area flat.
 - Keep the bucket low to the ground and close to the machine.
 - Reduce operating speeds to avoid tipping or slipping.
 - Avoid changing direction when traveling on grades.
 - NEVER attempt to travel across a grade steeper than 15 degrees if crossing the grade is unavoidable.
 - Reduce swing speed as necessary when swinging loads.
- Be careful when working on frozen ground.
 - Temperature increases will cause the ground to become soft and make ground travel unstable.

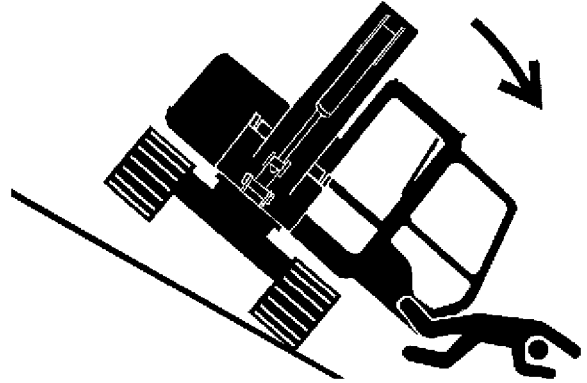

SA-012

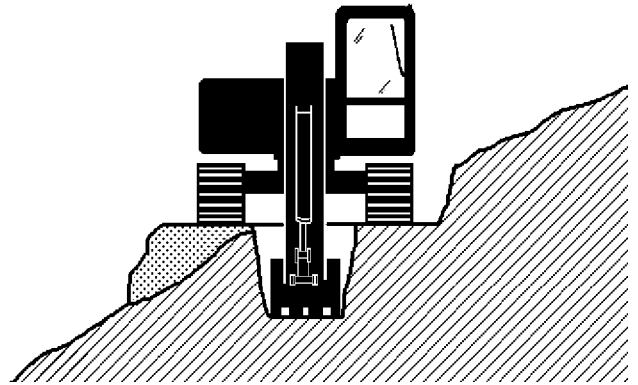

SA-440

025-E03B-0463

NEVER UNDERCUT A HIGH BANK

- The edges could collapse or a land slide could occur causing serious injury or death.

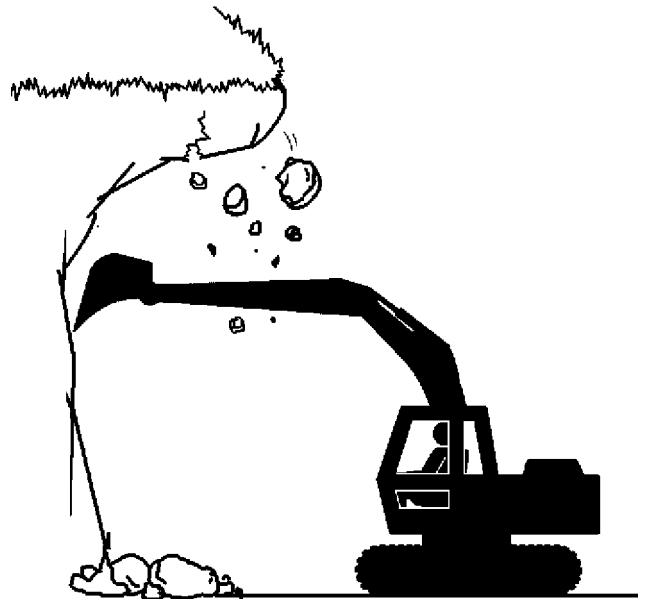

026-E01A-0519

SA-489

SAFETY

DIG WITH CAUTION

- Accidental severing of underground cables or gas lines may cause an explosion and/or fire, possibly resulting in serious injury or death.
- Before digging check the location of cables, gas lines, and water lines.
- Keep the minimum distance required, by law, from cables, gas lines, and water lines.
- If a fiber optic cable should be accidentally severed, do not look into the end. Doing so may result in serious eye injury.
- Contact your local "diggers hot line" if available in your area, and/or the utility companies directly. Have them mark all underground utilities.

027-E01A-0382

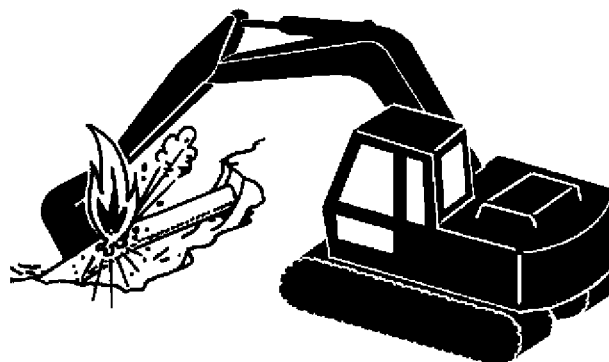

SA-382

OPERATE WITH CAUTION

- If the front attachment or any other part of the machine hits against an overhead obstacle, such as a bridge, both the machine and the overhead obstacle will be damaged, and personal injury may result as well.
- Take care to avoid hitting overhead obstacles with the boom or arm.

028-E01A-0389

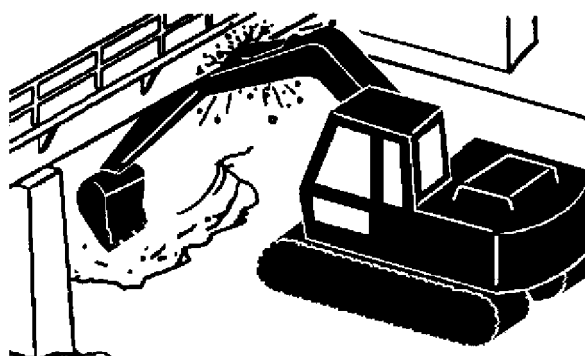

SA-389

SAFETY

AVOID POWER LINES

- Serious injury or death can result if the machine or front attachments are not kept a safe distance from electric lines.
- When operating near an electric line, NEVER move any part of the machine or load closer than 3 m plus twice the line insulator length.
- Check and comply with any local regulations that may apply.
- Wet ground will expand the area that could cause any person on it to be affected by electric shock. Keep all bystanders or co-workers away from the site.

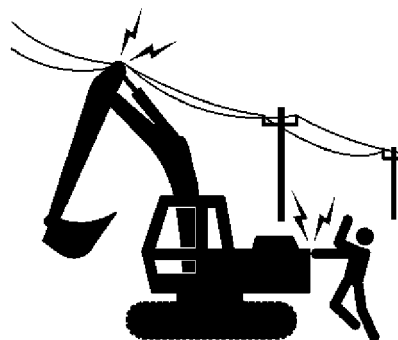

SA-381

029-E01A-0381

PRECAUTIONS FOR LIGHTNING

- The machine is vulnerable to lightning strikes.
- In the event of an electrical storm, immediately stop operation, and lower the bucket to the ground. Evacuate to a safe place far away from the machine.
- After the electrical storm has passed, check all of the machine safety devices for any failure. If any failed safety devices are found, operate the machine only after repairing them.



SA-1088

OBJECT HANDLING

- If a lifted load should fall, any person nearby may be struck by the falling load or may be crushed underneath it, resulting in serious injury or death.
- When using the machine for craning operations, be sure to comply with all local regulations.
- Do not use damaged chains or frayed cables, cables, slings, or ropes.
- Before craning, position the upperstructure with the travel motors at the rear.
- Move the load slowly and carefully. Never move it suddenly.
- Keep all persons well away from the load.
- Never move a load over a person's head.
- Do not allow anyone to approach the load until it is safely and securely situated on supporting blocks or on the ground.
- Never attach a sling or chain to the bucket teeth. They may come off, causing the load to fall.

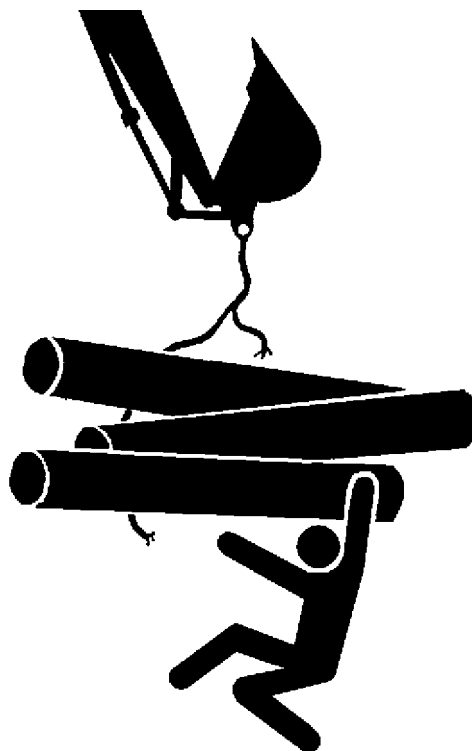

032-E01A-0132

SA-014

Thank you so much for reading.
Please click the “Buy Now!”
button below to download the
complete manual.



After you pay.

You can download the most
perfect and complete manual in
the world immediately.

Our support email:

ebooklibonline@outlook.com