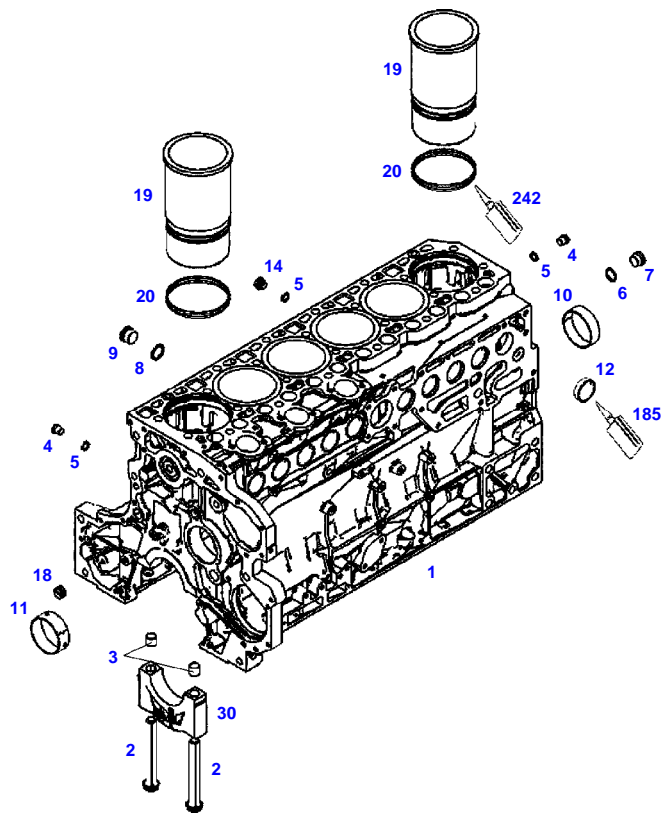

TABLE OF CONTENT

Page Number	Page Title	Page Reference
01-000-TOC	ENGINE, FUEL AND EXHAUST SYSTEM	01-000-TOC
02-000-TOC	AXLES	02-000-TOC
03-000-TOC	STEERING SYSTEM	03-000-TOC
04-000-TOC	DRIVE TRAIN SYSTEM	04-000-TOC
05-000-TOC	COMPRESSED AIR SYSTEM	05-000-TOC
06-000-TOC	HYDRAULIC SYSTEM	06-000-TOC
07-000-TOC	ELECTRICAL SYSTEM	07-000-TOC
08-000-TOC	CAB	08-000-TOC
09-000-TOC	AIR CONDITIONING AND HEATING SYSTEM	09-000-TOC
10-000-TOC	CHASSIS	10-000-TOC
11-000-TOC	WHEELS	11-000-TOC
12-000-TOC	IMPLEMENT LIFT SYSTEM FRONT	12-000-TOC
13-000-TOC	IMPLEMENT LIFT SYSTEM REAR	13-000-TOC
14-000-TOC	LINKAGE	14-000-TOC
15-000-TOC	PRECISION FARMING SYSTEMS	15-000-TOC
16-000-TOC	ACCESSORIES	16-000-TOC



050908

Item	Part Number	Qty	Description Comments	Technical Specification
			FROM ENGINE S/N 12315127	
	72611755	1	ENGINE FROM - UP TO MACHINE S/N 950/101 - 950/4999	TTCD7.8L6
	72627975	1	ENGINE FROM MACHINE S/N 950/5000	TTCD7.8L6
1	72629722	1	CRANKCASE ><2-30	
2	72451992	14	SCREW	
3	72451993	14	ADAPTER BUSH	
4	72631864	2	PLUG SCREW	
5	72439867	3	SEALING WASHER	DIN7603-14X18-CU-VERZ
6	72439874	1	SEALING WASHER	
7	72631865	1	PLUG SCREW	DIN908-M22X1,5
8	72485225	1	SEALING WASHER	26X31
9	72625841	1	PLUG SCREW	
10	72451995	6	BEARING BUSHING	
11	72614627	1	FEMALE BEARING	
12	72325325	10	CORE HOLE PLUG	
14	72631866	1	PLUG SCREW	
18	72431135	1	LOCKING PLUG	
19	72628452	6	CYLINDER LINER	
20	72415821	12	SEAL	
30				
			NOT AVAILABLE IN SINGLE PARTS	
185	72416485	1	SAFE LOCK AGENT	
242	72325276	1	INSTALLATION AIDS	

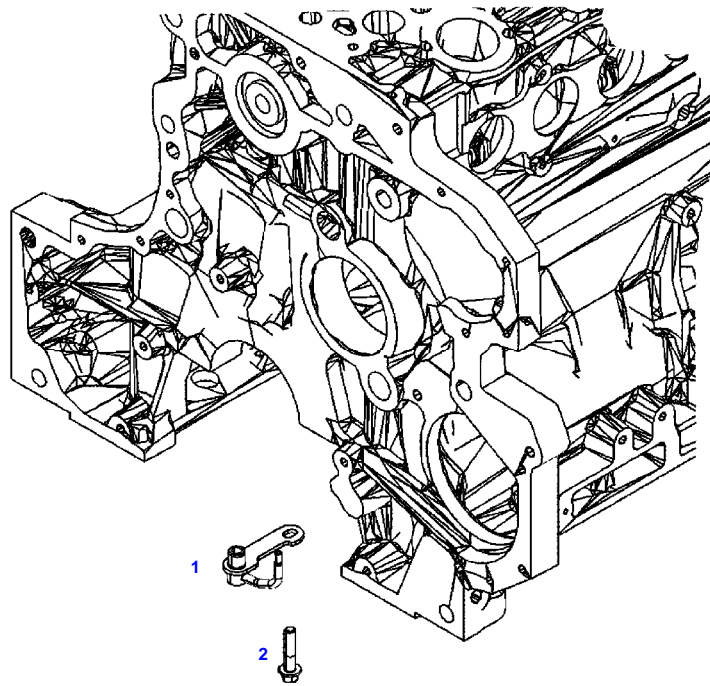

050909

Fendt

FENDT 927NA S4 (950/00101-05000) (WAM950XXX00F05001-99999)

F950105

CRANKCASE

Page01-0004

Item	Part Number	Qty	Description Comments	Technical Specification
			PISTON COOL.NOZZLE	
1	72614629	6	PISTON COOLING JET	
2	72605244	6	HEXAGONAL HEAD BOLT	M8X35

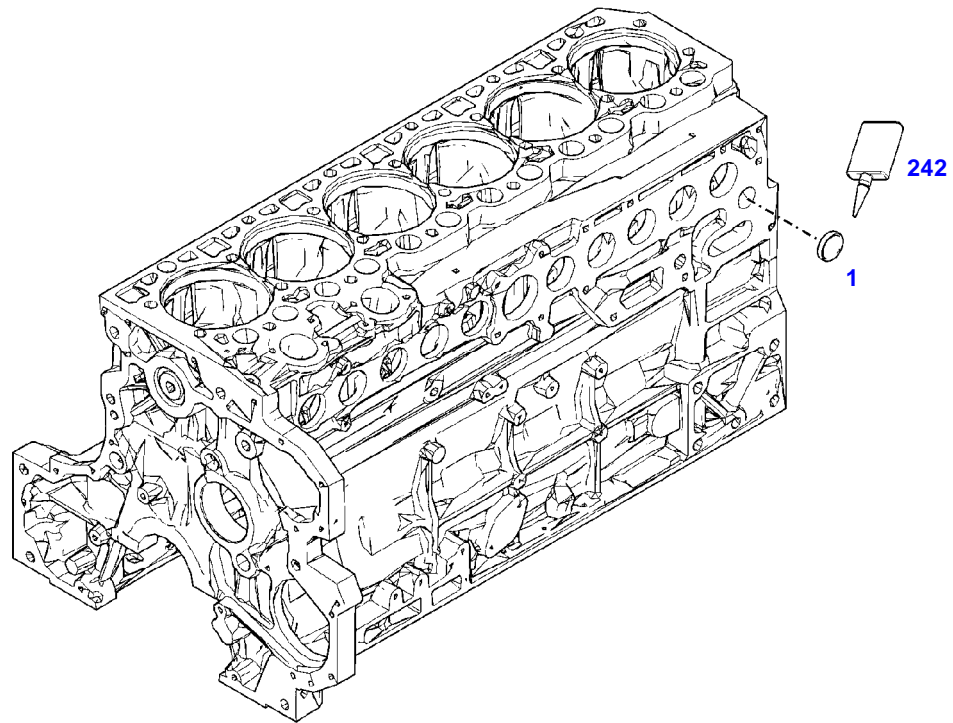

041319

Fendt

FENDT 927NA S4 (950/00101-05000) (WAM950XXX00F05001-99999)

F950105

CRANKCASE

Page01-0005

Item	Part Number	Qty	Description Comments	Technical Specification
			LOCKING PLUG	
1	72485243	1	CORE HOLE PLUG	
242	72381391	1	THREADLOCKER	LOCTITE 243 10ML

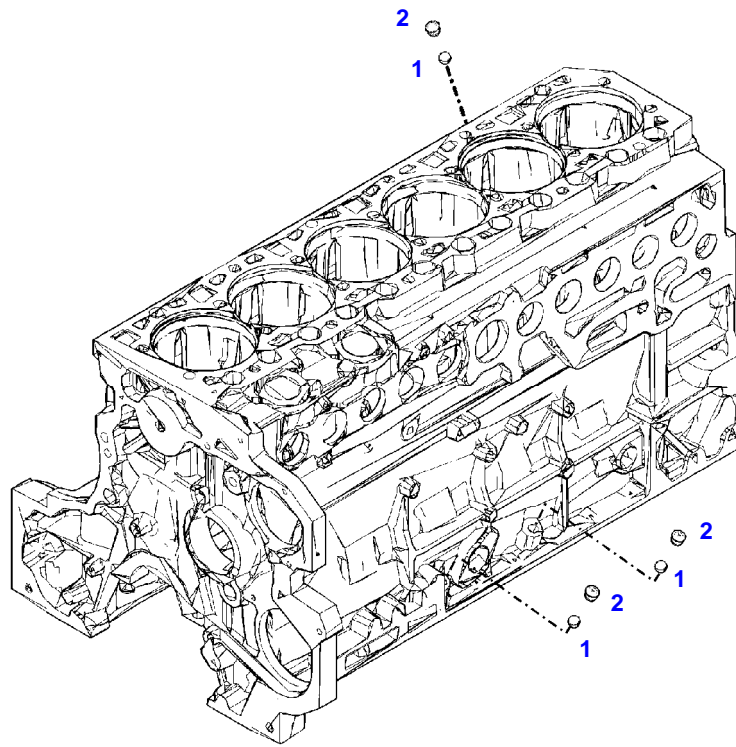

041284

Fendt

FENDT 927NA S4 (950/00101-05000) (WAM950XXX00F05001-99999)

F950105

CRANKCASE

Page01-0006

Item	Part Number	Qty	Description Comments
			LOCKING PLUG
1	72484231	3	BALL
2	72611452	3	LOCKING PLUG

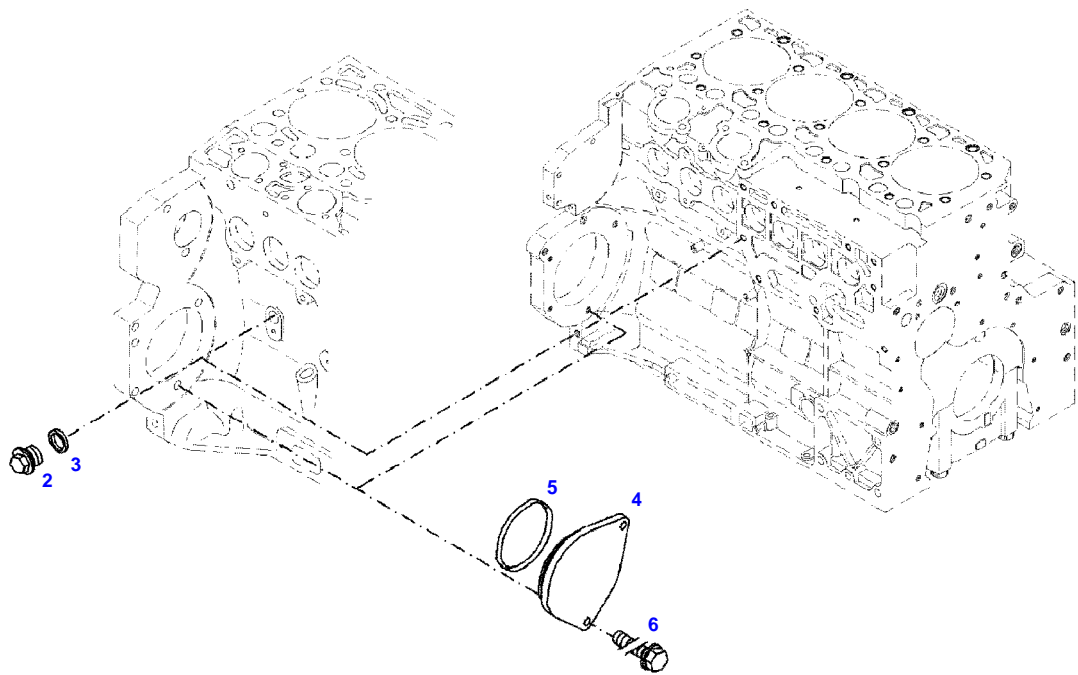

051577



Item	Part Number	Qty	Description Comments	Technical Specification
BLANKING PARTS				
2	72315799	1	PLUG NOT NEEDED WITH AIR BRAKE	DIN 7604 AM14X1,5-A3L
3	72439867	1	SEALING WASHER NOT NEEDED WITH AIR BRAKE	DIN7603-14X18-CU-VERZ
4	72431648	1	COVER NOT NEEDED WITH AIR BRAKE	
5	72416472	1	SEAL 96X4MM NOT NEEDED WITH AIR BRAKE	
6	72438057	2	HEXAGONAL HEAD BOLT NOT NEEDED WITH AIR BRAKE UP TO 2017-08	M10X20
	72657640	2	HEXAGONAL HEAD BOLT NOT NEEDED WITH AIR BRAKE FROM 2017-09	M10X16

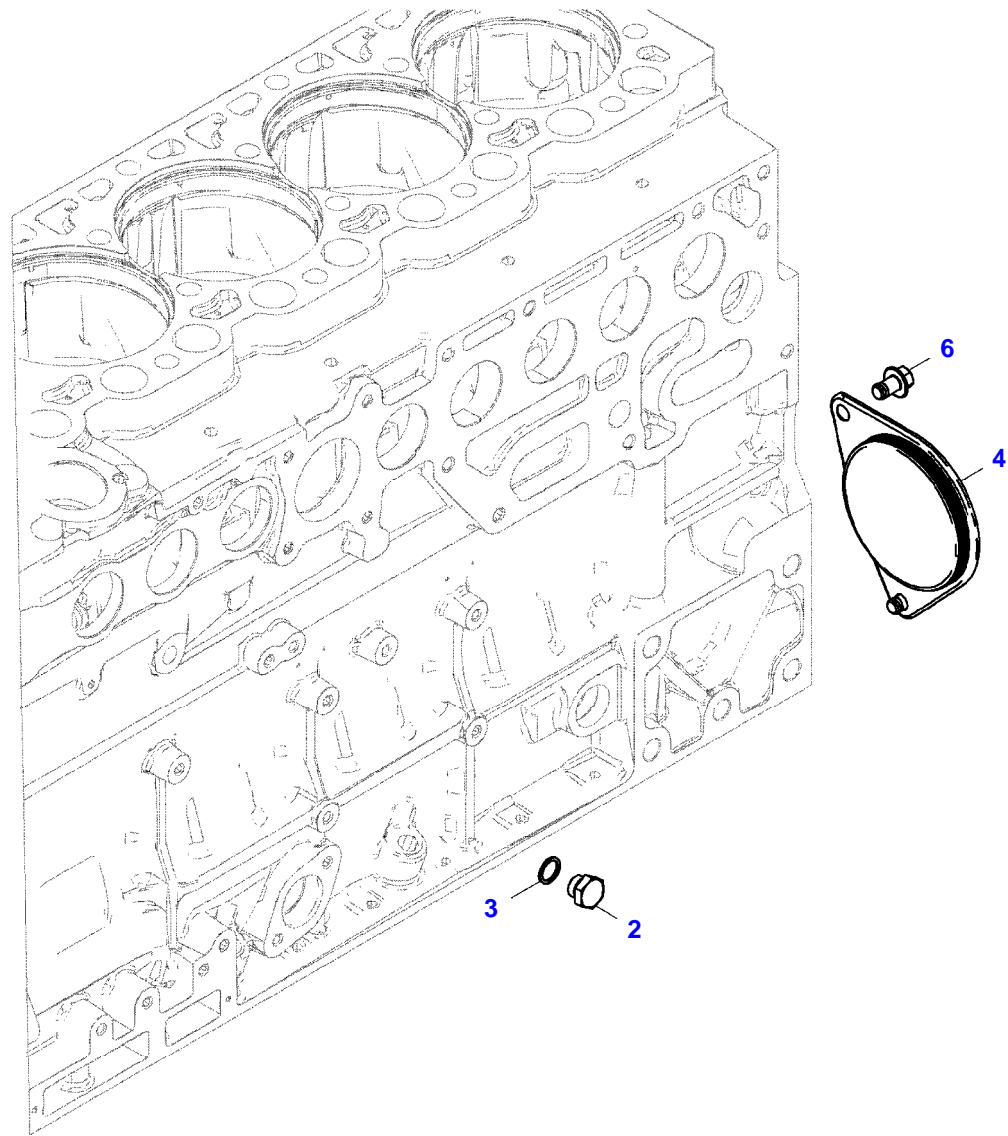

25548786-M-1

Item	Part Number	Qty	Description Comments	Technical Specification
			BLANKING PARTS FROM ENGINE S/N 12162508	
2	72631866	1	PLUG SCREW NOT NEEDED WITH AIR BRAKE	
3	72439867	1	SEALING WASHER NOT NEEDED WITH AIR BRAKE	DIN7603-14X18-CU-VERZ
4	72657732	1	COVER NOT NEEDED WITH AIR BRAKE	
6	72657640	2	HEXAGONAL HEAD BOLT	M10X16

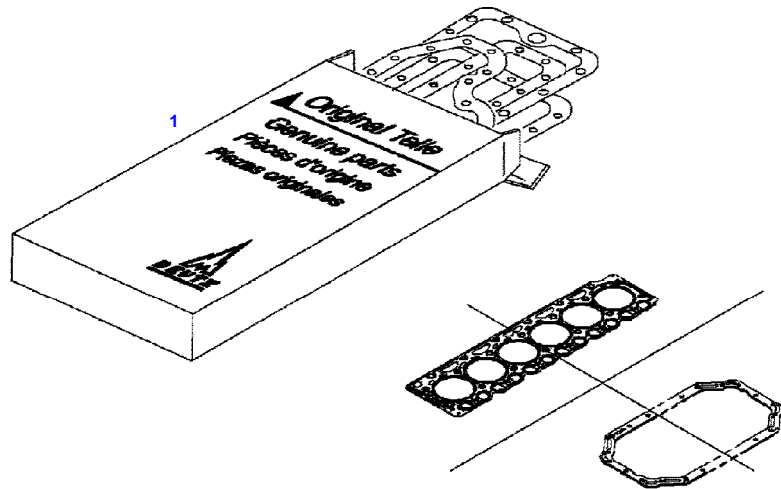

050910

Fendt

FENDT 927NA S4 (950/00101-05000) (WAM950XXX00F05001-99999)

F950105

SET OF GASKETS - MOTOR

Page01-0009

Item	Part Number	Qty	Description Comments
1	72614630	1	SEAL KIT WITHOUT CYLINDER HEAD GASKET WITHOUT SEAL OIL SUMP

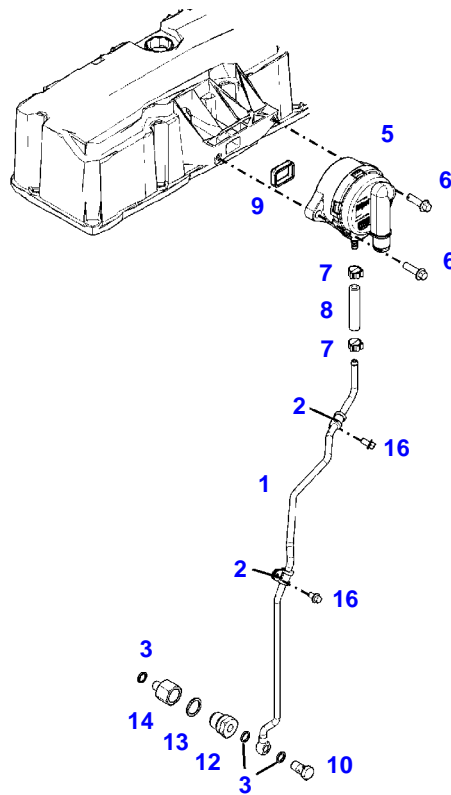

041330

Item	Part Number	Qty	Description Comments	Technical Specification
1	72487609	1	RETURN LINE ><2,3,10	
2	72454982	2	PIPE CLAMP	
3	72315090	3	SEALING WASHER	DIN 7603 A12X15,5-CU
5	72437250	1	BREATHER ><9	
6	72325293	2	HEXAGONAL HEAD BOLT M8X30	M8X30
7	72607524	2	HOSE CLIP	
8	72452001	1	RUBBER HOSE	
9	72455795	1	SEAL	
10	72323517	1	BANJO BOLT	
12	72485771	1	LOCK VALVE ><13,14	
13	72315101	1	SEALING WASHER	DIN 7603 A22X27-CU
14	72452004	1	ADAPTER	
16	72325300	2	HEXAGONAL HEAD BOLT M6X12	M6X12

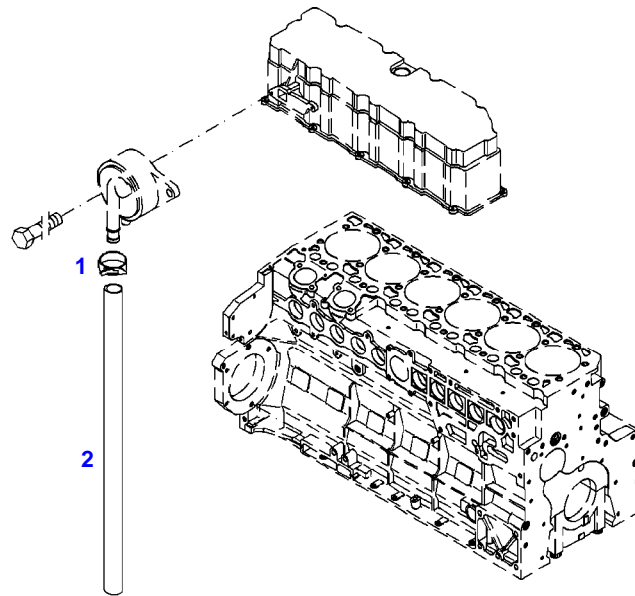

035675

Fendt

FENDT 927NA S4 (950/00101-05000) (WAM950XXX00F05001-99999)

F950105

CRANKCASE BREATHER

Page01-0011

Item	Part Number	Qty	Description Comments	Technical Specification
			BREATHER TUBE	
1	72311167	1	HOSE CLIP	
2	72450415	1	HOSE	L=900 DIN73411-22X3,5 R

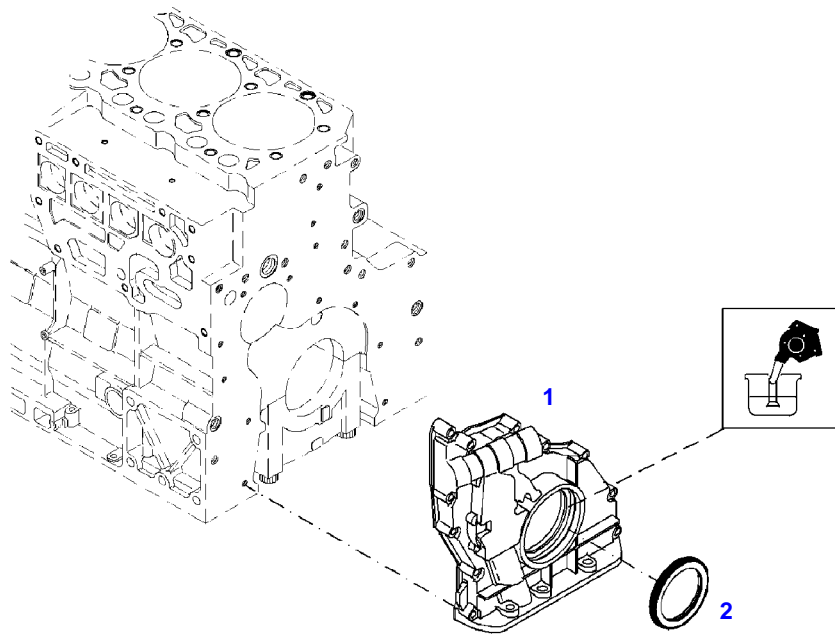

041280

Fendt

FENDT 927NA S4 (950/00101-05000) (WAM950XXX00F05001-99999)

F950105

FRONT COVER

Page01-0012

Item	Part Number	Qty	Description Comments
			INTEGRATED OIL PUMP
1	72485249	1	CRANKCASE END COVER ><2
2	72485251	1	SHAFT SEAL

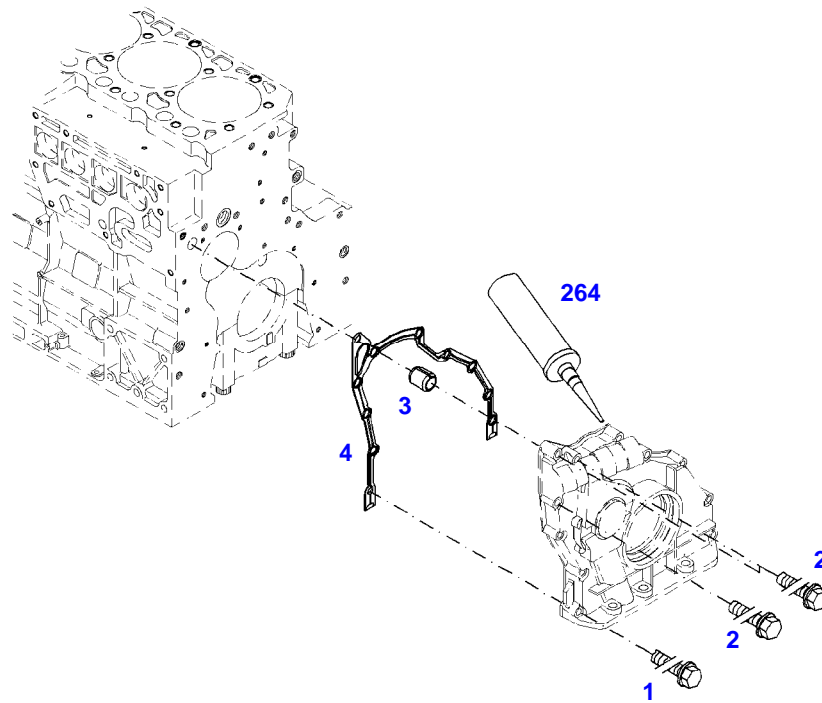

040931

Fendt

FENDT 927NA S4 (950/00101-05000) (WAM950XXX00F05001-99999)

F950105

FRONT COVER

Page01-0013

Item	Part Number	Qty	Description Comments	Technical Specification
FASTENINGS				
1	72605244	8	HEXAGONAL HEAD BOLT	M8X35
2	72452006	3	HEXAGONAL HEAD BOLT M8X70	
3	72325352	1	TENSIONER BUSHING	
4	72452007	1	SEAL	
264	72438062	1	SEALING COMPOUND	

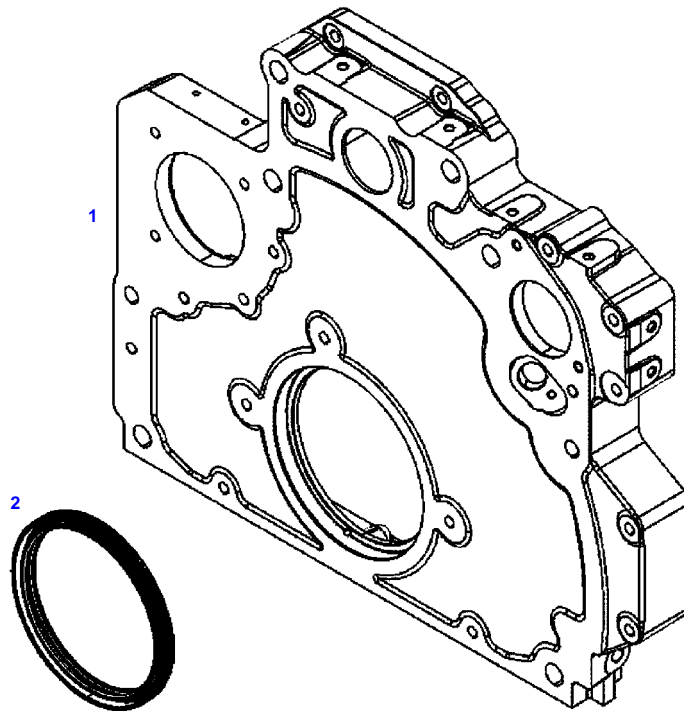

050911

Fendt

FENDT 927NA S4 (950/00101-05000) (WAM950XXX00F05001-99999)

F950105

GEARCASE

Page01-0014

Item	Part Number	Qty	Description Comments
1	72619324	1	WHEEL BOX
2	72488927	1	SHAFT SEAL

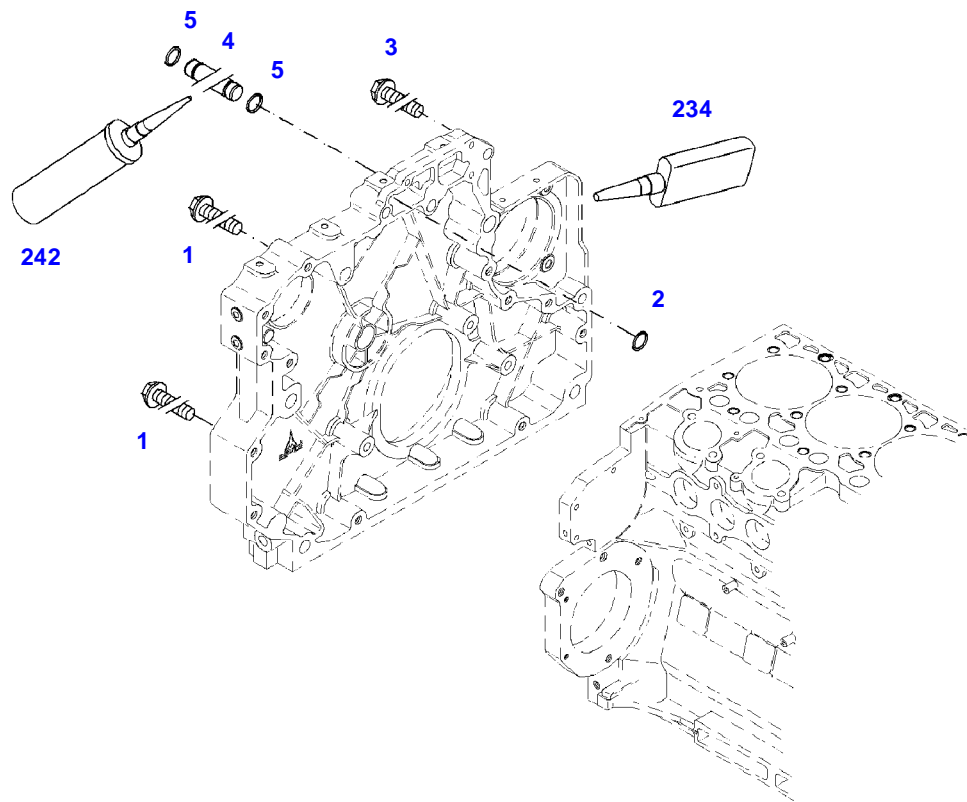

041039

Item	Part Number	Qty	Description Comments	Technical Specification
FASTENINGS				
1	72325393	8	HEXAGONAL HEAD BOLT M8X65	
2	72415664	1	SEAL 7X3MM	
3	72325293	2	HEXAGONAL HEAD BOLT M8X30	M8X30
4	72452009	1	BOLT ><5	
5	72452010	2	SEAL 42X4MM	
234	72325408	1	SEALING COMPOUND	
242	72325276	1	INSTALLATION AIDS	

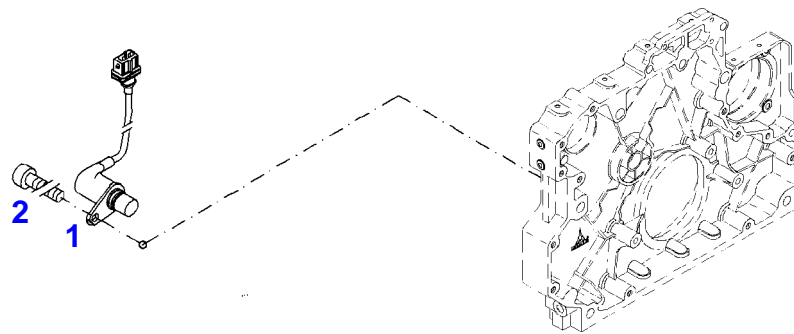

040932

Fendt

FENDT 927NA S4 (950/00101-05000) (WAM950XXX00F05001-99999)

F950105

IMPULSETRANSMITTER

Page01-0016

Item	Part Number	Qty	Description Comments	Technical Specification
			CAM SHAFT	
1	72452011	1	ENGINE SPEED SENSOR CAM SHAFT	
2	72315460	1	SOCKET HEAD BOLT	DIN 912 M6X16-8.8

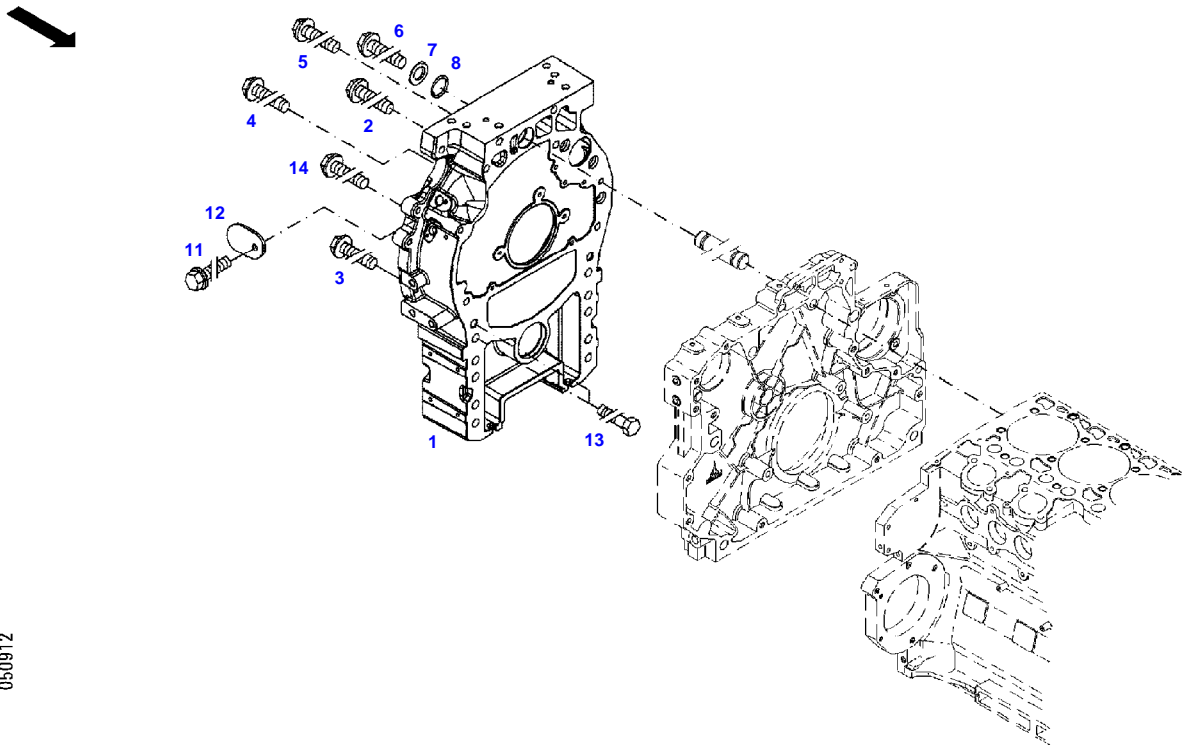

050912

Item	Part Number	Qty	Description Comments	Technical Specification
1	72437820	1	CONNECTING HOUSING	
2	72452012	1	HEXAGONAL HEAD BOLT M16X200	
3	72452013	3	HEXAGONAL HEAD BOLT M16X120	
4	72452014	8	HEXAGONAL HEAD BOLT M8X70	
5	72452015	1	HEXAGONAL HEAD BOLT M12X130	
6	72452015	1	HEXAGONAL HEAD BOLT M16X1,5X180	
7	72452021	1	DISC	
8	72452017	1	SEAL 16X4MM	
11	72415878	1	HEXAGONAL HEAD BOLT M8X16	
12	72614631	1	LID	
13	72374344	2	HEXAGONAL HEAD BOLT	DIN 931 M20X70-10.9
14	72452019	1	HEXAGONAL HEAD BOLT M12X190	

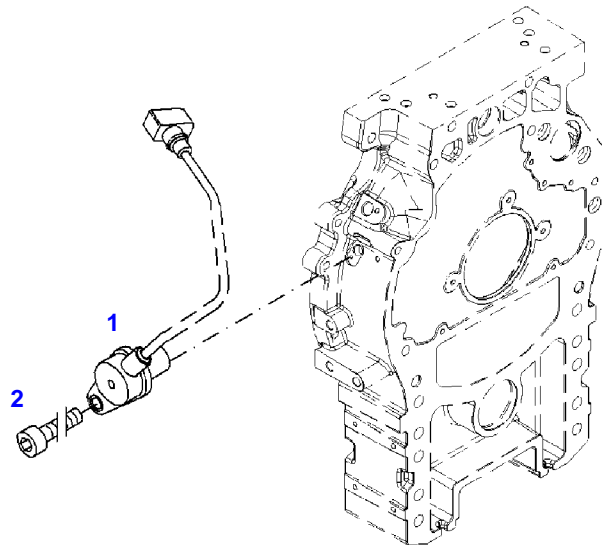

040934

Fendt

FENDT 927NA S4 (950/00101-05000) (WAM950XXX00F05001-99999)

F950105

IMPULSETRANSMITTER

Page01-0018

Item	Part Number	Qty	Description Comments	Technical Specification
			FLYWHEEL	
1	72436872	1	TRANSMITTER FLYWHEEL	
2	72315460	1	SOCKET HEAD BOLT	DIN 912 M6X16-8.8

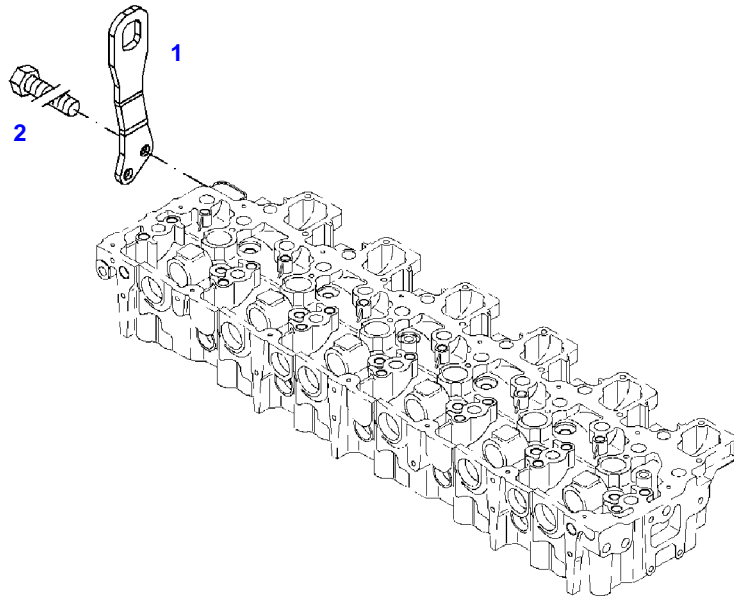

041281

Fendt

FENDT 927NA S4 (950/00101-05000) (WAM950XXX00F05001-99999)

F950105

ENGINE MOUNTING

Page01-0019

Item	Part Number	Qty	Description Comments
1	72485279	1	SUSPENSION PLATE
2	72485277	2	HEXAGONAL HEAD BOLT M12X25

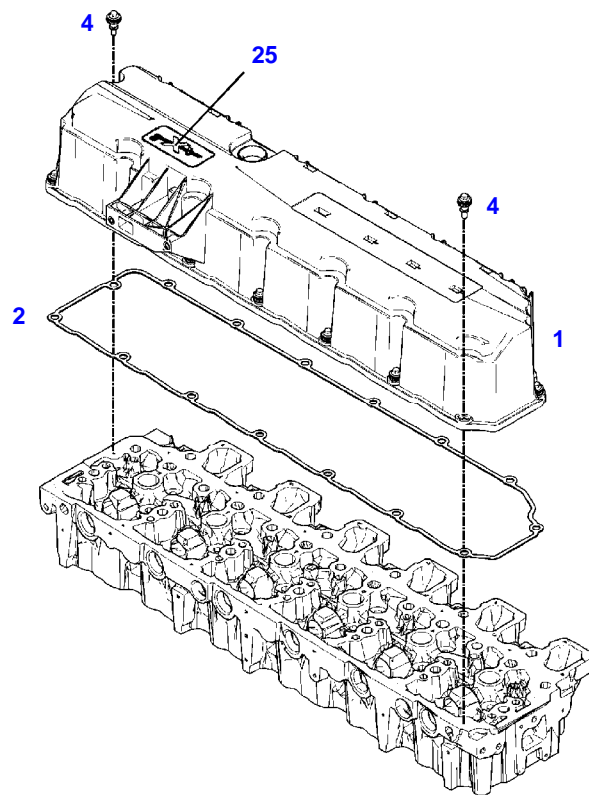

041388

Fendt

FENDT 927NA S4 (950/00101-05000) (WAM950XXX00F05001-99999)

F950105

VALVE COVER

Page01-0020

Item	Part Number	Qty	Description Comments
1	72493980	1	VALVE COVER ><2,4
2	72451950	1	SEAL
4	72452027	15	SCREW
25		1	NO SPARE PART

Thank you so much for reading.
Please click the “Buy Now!”
button below to download the
complete manual.



After you pay.

You can download the most
perfect and complete manual in
the world immediately.

Our support email:

ebooklibonline@outlook.com