

Operator's Manual

ZAXIS

70-3

70LC-3

75US-3

80LCK-3

85USB-3

Hydraulic Excavator

Serial No.

ZX70-3	080000 and up
ZX70LC-3	080001 and up
ZX75US-3	060001 and up
ZX80LCK-3	080001 and up
ZX85USB-3	080001 and up

INDEX

MACHINE NUMBERS

SAFETY

SAFETY SIGNS

COMPONENTS NAME

OPERATOR'S STATION

BREAK-IN

OPERATING THE ENGINE

DRIVING THE MACHINE

OPERATING THE MACHINE

TRANSPORTING

MAINTENANCE

MAINTENANCE UNDER SPECIAL ENVIRONMENTAL CONDITIONS

STORAGE

TROUBLESHOOTING

SPECIFICATIONS

OPTIONAL ATTACHMENTS AND DEVICES

INDEX

MACHINE NUMBERS

The manufacturing Nos. explained in this group is the individual number (serial No.) given to each machine and hydraulic components. These numbers are requested when inquiring any information on the machine and/or components. Fill these serial Nos. in the blank spaces in this group to immediately make them available upon request.

MACHINE

TYPE: _____
PRODUCT
IDENTIFICATION
NUMBER: _____

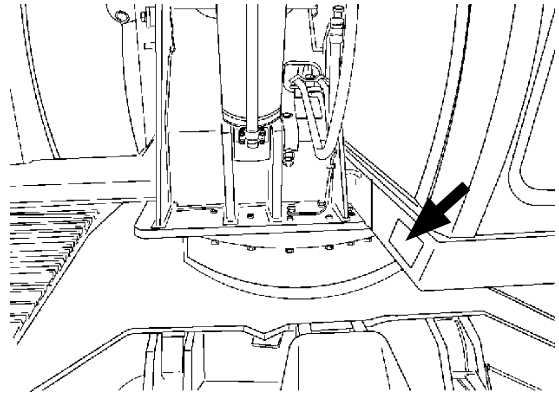

M1CD-01-002

PRODUCT IDENTIFICATION NUMBER

PRODUCT
IDENTIFICATION
NUMBER: _____

 **NOTE:** Marks to indicate the start and end of the PIN

HCM1P100L00100001 PIN

PRODUCT IDENTIFICATION
NUMBER (PIN)

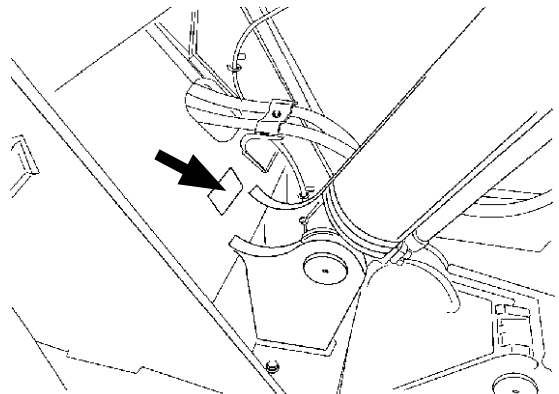

M1CD-01-003

ENGINE

TYPE: _____
MFG. NO.: _____

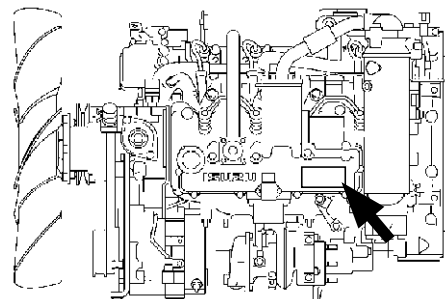

M1P1-01-001

MACHINE NUMBERS

TRAVEL MOTOR

TYPE: _____

MFG. NO.: _____

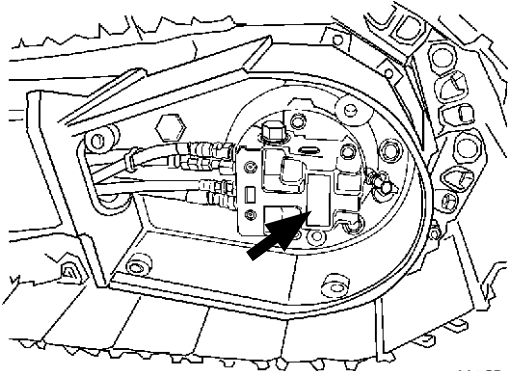

M1CD-01-005

SWING MOTOR

TYPE: _____

MFG. NO.: _____

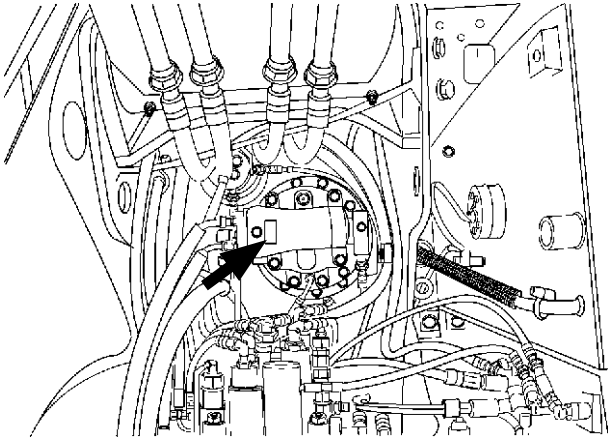

M1CD-07-004

HYDRAULIC PUMP

TYPE: _____

MFG. NO.: _____

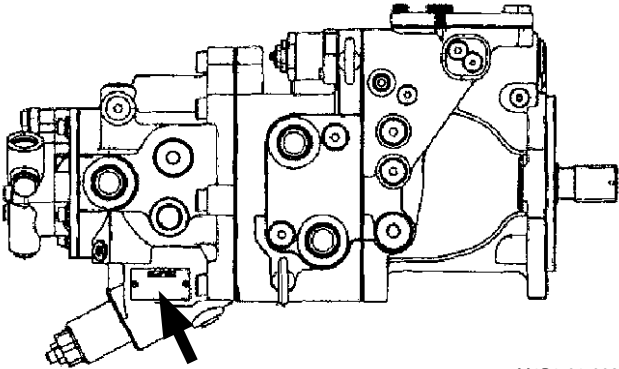

M1P1-01-002

CONTENTS

MACHINE NUMBERS

SAFETY

Recognize Safety Information	S-1
Understand Signal Words	S-1
Follow Safety Instructions	S-2
Prepare for Emergencies	S-3
Wear Protective Clothing	S-3
Protect Against Noise	S-3
Inspect Machine	S-4
General Precautions for Cab	S-4
Use Handholds and Steps	S-5
Adjust the Operator's Seat	S-5
Ensure Safety Before Rising From or Leaving Operator's Seat	S-5
Fasten Your Seat Belt	S-6
Move and Operate Machine Safely	S-6
Handle Starting Aids Safely	S-6
Operate Only From Operator's Seat	S-7
Jump Starting	S-7
Keep Riders Off Machine	S-7
Precautions for Operations	S-8
Investigate Job Site Beforehand	S-9
Equipment of Head Guard, Rops, Fops	S-10
Provide Signals for Jobs Involving Multiple Numbers of Machines	S-10
Confirm Direction of Machine to Be Driven	S-10
Drive Machine Safely	S-11
Avoid Injury From Rollaway Accidents	S-13
Avoid Injury From Back-over and Swing Accidents	S-14
Keep Person Clear From Working Area	S-15
Never Position Bucket Over Anyone	S-15
Avoid Undercutting	S-15
Avoid Tipping	S-16
Never Undercut a High Bank	S-16
Dig with Caution	S-17
Operate with Caution	S-17
Avoid Power Lines	S-18
Precautions for Lightning	S-18
Object Handling	S-18
Protect Against Flying Debris	S-19
Park Machine Safely	S-19
Handle Fluids Safely—avoid Fires	S-19
Transport Safely	S-20
Practice Safe Maintenance	S-21
Warn Others of Service Work	S-22
Support Machine Properly	S-22
Stay Clear of Moving Parts	S-22
Prevent Parts From Flying	S-23
Store Attachments Safely	S-23
Prevent Burns	S-24
Replace Rubber Hoses Periodically	S-24
Avoid High-pressure Fluids	S-25
Prevent Fires	S-26
Evacuating in Case of Fire	S-28

Beware of Exhaust Fumes	S-28
Precautions for Welding and Grinding	S-28
Avoid Heating Near Pressurized Fluid Lines	S-29
Avoid Applying Heat to Lines Containing Flammable Fluids	S-29
Remove Paint Before Welding or Heating	S-29
Beware of Asbestos Dust	S-30
Prevent Battery Explosions	S-30
Service Air Conditioning System Safely	S-30
Handle Chemical Products Safely	S-31
Dispose of Waste Properly	S-31
Precaution for Communication Teaminal Equipment	S-32

SAFETY SIGNS	S-33
---------------------------	------

COMPONENTS NAME	1-1
------------------------------	-----

GETTING ON/OFF THE MACHINE	1-2
---	-----

OPERATOR'S STATION

Cab Features	1-3
Multi Function Monitor	1-5
Basic Screen	1-6
Monitor Operation	1-7
Displaying Basic Screen	1-7
Hour Meter (8)	1-8
Fuel Gauge (10)	1-8
Clock (13)	1-8
Coolant Temperature Gauge (21)	1-8
Back Monitor Screen Selector (14) (Optional)	1-9
Menu Key (15)	1-10
Optional Function Keys (16, 17, 18 and 19)	1-10
Return to basic Screen Key (20)	1-10
Menu Screen	1-13
Alarm Occurrence Screen	1-18
Alarm List	1-19
Clock Setting	1-20
Maintenance Setting	1-21
Mail (Optional)	1-27
Password Revising (Optional)	1-29
Back Monitor Setting (Optional)	1-32
Language Setting	1-35
Monitoring	1-37
Switch Panel	1-38
Engine Control Dial	1-40
Auto-idle Switch	1-40
Power Mode Switch	1-41
Travel Mode Switch	1-41
Work Light Switch	1-42
Wiper/Washer Switch	1-43
Switch Panel (Optional)	1-45
Key Switch	1-47
Horn Switch	1-47
Cigar Lighter	1-48
Cab Light	1-49

CONTENTS

Installing Fire Extinguisher (Optional)	1-49	Attachment Pedal (Hydraulic Breaker)	5-2
Pilot Control Shut-off Lever	1-50	Attachment Pedal (Hydraulic Crusher)	5-3
Engine Stop Knob	1-51	Blade Lever	5-4
Fuse Box	1-52	Precautions For Blade Operation	5-4
Auto Air Conditioner	1-53	Pilot Control Shut-off Lever	5-5
Cab Heater Operation	1-56	Warming-up Operation	5-6
Cooling Operation	1-57	Engine Speed Control	5-7
Defroster Operation	1-58	Auto-idle	5-8
Tips for Optimal Air Conditioner Usage	1-59	Power Mode	5-9
Cab Heater (Optional)	1-60	Operating Backhoe	5-10
Cab Heater Operation	1-62	Grading Operation	5-10
Defroster Operation	1-63	Face Shovel Operation	5-11
AM/FM Radio Operation	1-64	Avoid Abusive Operation	5-11
Cab Door Release Lever	1-67	Operating Tips	5-12
Opening Upper Front Window	1-68	Select Correct Track Shoes	5-12
Closing Upper Front Window	1-70	Avoid Hitting Blade With Front-end Attachment	5-13
Removing and Storing Lower Front Window	1-71	Avoid Hitting Blade With Bucket	5-13
Opening Side Windows	1-72	Avoid Striking The Blade Into A Rock	5-13
Opening/Closing Overhead Window	1-73	Hydraulic Breaker and Hydraulic Crusher	5-14
Emergency Exit	1-74	Pipings for Breaker and Crusher	5-15
Adjusting the Seat	1-76	Secondary Relief Pressure Adjustment	5-16
Adjusting the Seat (Optional)	1-77	Precautions for Breaker Operation	5-17
Adjusting Console Height	1-79	Breaker Maintenance	5-20
Seat Belt	1-80	Precautions for Crusher Operation	5-21
BREAK-IN		Attachment	5-23
Observe Engine Operation Closely	2-1	Attachment Connection Parts	5-26
Every 8 Hours or Daily	2-1	Precaution for Arm Roll-in/bucket Roll-in	
After the First 50 Hours	2-1	Combined Operation --- If Headguard-integrated	
After the First 100 Hours	2-1	Cab or Rainguard is Equipped	5-27
OPERATING THE ENGINE		When Installing an Attachment Longer	
Inspect Machine Daily Before Starting	3-1	Than Standard Bucket	5-27
Before Starting Engine	3-2	Shackle Hole Usage	5-28
Starting the Engine in Ordinary Temperature	3-3	Overnight Storage Instructions	5-28
Starting in Cold Weather	3-5	Emergency Boom Lowering Procedure	
Check Instruments After Starting	3-6	(Without Hose-rupture Safety Valve)	5-29
Using Booster Batteries	3-7	Object Handling --- If Equipped	5-30
Stopping the Engine	3-9	TRANSPORTING	
DRIVING THE MACHINE		Transporting by Road	6-1
Drive the Machine Carefully	4-1	Loading/Unloading on a Trailer	6-1
Steering the Machine Using Pedals	4-2	Machine Lifting Procedure	6-5
Steering the Machine Using Levers	4-3	MAINTENANCE	
Travel Mode Switch	4-4	Correct Maintenance and Inspection Procedures	7-1
Travel Alarm (Optional)	4-5	Check the Hour Meter Regularly	7-2
Operating on Soft Ground	4-6	Use Correct Fuels and Lubricants	7-2
Raise One Track Using Boom and Arm	4-6	Layout	7-3
Towing Machine a Short Distance	4-7	Maintenance Guide Table	7-4
Operating in Water or Mud	4-8	Prepare Machine for Maintenance	7-6
Parking the Machine on Slopes	4-9	Hood and Access Covers	7-7
Parking the Machine	4-9	Periodic Replacement of Parts	7-9
OPERATING THE MACHINE		Use Electrical Outlet	7-10
Control Lever (ISO Pattern)	5-1	Maintenance Guide	7-11
		A. Greasing	7-16
		Front Joint Pins	7-16

CONTENTS

Swing Bearing.....	7-18	Clean and Replace Air Conditioner Filter	
Swing Internal Gear.....	7-19	Clean Filter.....	7-74
Maintenance Blade Joint Pins.....	7-20	Replace Filter.....	7-74
B. Engine.....	7-21	Check the Air Conditioner.....	7-78
Engine Oil Level.....	7-21	Clean Cab Floor.....	7-79
Change Engine Oil.....	7-22	Check Injection Nozzle.....	7-80
Replace Engine Oil Filter.....	7-22	Retighten Cylinder Head Bolt.....	7-80
C. Transmission.....	7-24	Inspect and Adjust Valve Clearance.....	7-80
Travel Reduction Gear.....	7-24	Check Fuel Injection Timing.....	7-80
D. Hydraulic System.....	7-26	Check Starter and Alternator.....	7-80
Inspection and Maintenance of		Check and Replace EGR Device.....	7-80
Hydraulic Equipment.....	7-26	Measure Engine Compression Pressure.....	7-80
Breaker Maintenance.....	7-28	Check Tightening Torque of Bolts and Nuts.....	7-81
Check Hydraulic Oil Level.....	7-29		
Drain Hydraulic Oil Tank Sump.....	7-30	MAINTENANCE UNDER SPECIAL	
Change Hydraulic Oil.....	7-31	ENVIRONMENTAL CONDITIONS	
Suction Filter Cleaning.....	7-31	Maintenance Under Special Environmental Conditions..	9-1
Replace Hydraulic Oil Tank Filter.....	7-34		
Replace Pilot Oil Filter.....	7-35	STORAGE	
Replace Swing Drain Filter Element.....	7-36	Storing the Machine.....	10-1
Replace Air Breather Element.....	7-37	Removing the Machine from Storage.....	10-2
Check Hoses and Lines.....	7-38		
Service Recommendations for Hydraulic Fittings.....	7-41	TROUBLESHOOTING	
E. Fuel System.....	7-43	Impossible to Start the Engine.....	11-1
Drain Fuel Tank Sump.....	7-45	Engine.....	11-2
Check Water Separator.....	7-46	Electrical System.....	11-6
Replace Fuel Filter Element.....	7-48	Mode Selection.....	11-8
Clean Fuel Solenoid Pump Strainer.....	7-49	Control Levers.....	11-9
Check Fuel Hoses.....	7-50	Hydraulic System.....	11-10
F. Air Cleaner.....	7-51		
Clean the Air Cleaner Outer Element.....	7-51	SPECIFICATIONS	
Replace the Air Cleaner Outer and Inner Elements..	7-51	Specifications	
G. Cooling System.....	7-53	(ZX70-3, 70LC-3).....	12-1
Check Coolant Level.....	7-54	Working Ranges	
Check and Adjust Fan Belt Tension.....	7-55	(ZX70-3, 70LC-3).....	12-2
Change Coolant.....	7-56	Shoe Types and Applications	
Clean Radiator Interior.....	7-56	(ZX70-3, 70LC-3).....	12-3
Clean Radiator, Oil Cooler and Inter Cooler Core.....	7-57	Specifications	
Clean Oil Cooler, Radiator and Inter		(ZX75US-3).....	12-4
Cooler Front Screen.....	7-57	Working Ranges	
Clean Air Conditioner Condenser.....	7-57	(ZX75US-3).....	12-5
H. Electrical System.....	7-58	Shoe Types and Applications (with Blade)	
Batteries.....	7-58	(ZX75US-3).....	12-6
Replace Batteries.....	7-61	Specifications	
Replacing Fuses.....	7-62	(ZX80LCK-3).....	12-7
Additional Fuse Box (Optional).....	7-64	Working Ranges	
I. Miscellaneous.....	7-65	(ZX80LCK-3).....	12-8
Check Bucket Teeth.....	7-65	Shoe Types and Applications	
Change Bucket.....	7-67	(ZX80LCK-3).....	12-9
Convert Bucket Connection Into Face Shovel.....	7-68	Specifications	
Adjust the Bucket Linkage.....	7-69	(ZX85USB-3).....	12-10
Remove the Travel Levers.....	7-70	Working Ranges	
Check and Replace Seat Belt Check.....	7-70	(ZX85USB-3).....	12-11
Check Windshield Washer Fluid Level.....	7-71	Shoe Types and Applications	
Check Track Sag.....	7-72	(ZX85USB-3).....	12-12

CONTENTS

OPTIONAL ATTACHMENTS AND DEVICES

Specifications	
(ZX70-3, 70LC-3) (with Blade).....	13-1
Working Ranges	
(ZX70-3, 70LC-3) (with Blade).....	13-2
Shoe Types and Applications	
(ZX70-3, 70LC-3) (with Blade).....	13-3
Specifications	
(ZX75US-3) (with Blade).....	13-4
Working Ranges	
(ZX75US-3) (with Blade).....	13-5
Shoe Types and Applications	
(ZX75US-3) (with Blade).....	13-6
Specifications	
(ZX80LCK-3) (with Blade).....	13-7
Working Ranges	
(ZX80LCK-3) (with Blade).....	13-8
Shoe Types and Applications	
(ZX80LCK-3) (with Blade).....	13-9
Offset Arm Front.....	13-10
Precautions For Operating With The Offset Function ...	13-12
Maintenance.....	13-13
Specifications	
(ZX70-3,70LC-3) (with Offset Arm Front).....	13-14
Working Ranges	
(ZX70-3,70LC-3) (with Offset Arm Front).....	13-17
Shoe Types and Applications	
(ZX70-3,70LC-3) (with Offset Arm Front).....	13-18
Specifications	
(ZX75US-3) (with Offset Arm Front).....	13-20
Working Ranges	
(ZX75US-3) (with Offset Arm Front).....	13-21
Shoe Types and Applications	
(ZX75US-3) (with Offset Arm Front).....	13-22
Registration/Registration	
Cancellation Of Ordinary Operation Key.....	13-23
Additional Registration Procedure.....	13-24
Registration Deactivation Procedure	
(To Make The Lost Key Unavailable).....	13-25
INDEX	14-1

SAFETY

RECOGNIZE SAFETY INFORMATION

- These are the **SAFETY ALERT SYMBOLS**.
 - When you see these symbols on your machine or in this manual, be alert to the potential for personal injury.
 - Follow recommended precautions and safe operating practices.

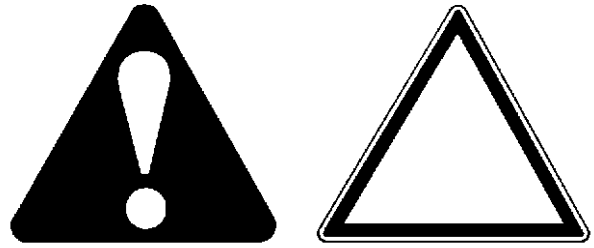

001-E01A-0001

SA-688

UNDERSTAND SIGNAL WORDS

- On machine safety signs, signal words designating the degree or level of hazard - **DANGER**, **WARNING**, or **CAUTION** - are used with the safety alert symbol.
 - **DANGER** indicates an imminently hazardous situation which, if not avoided, will result in death or serious injury.
 - **WARNING** indicates a potentially hazardous situation which, if not avoided, could result in death or serious injury.
 - **CAUTION** indicates a potentially hazardous situation which, if not avoided, may result in minor or moderate injury.
 - **DANGER or WARNING safety signs** are located near specific hazards. General precautions are listed on **CAUTION safety signs**.
 - Some safety signs do not use any of the designated signal words above after the safety alert symbol are occasionally used on this machine.
- To avoid confusing machine protection with personal safety messages, a signal word **IMPORTANT** indicates a situation which, if not avoided, could result in damage to the machine.
-  **NOTE** indicates an additional explanation for an element of information.



IMPORTANT



002-E01A-1223

SA-1223

SAFETY

FOLLOW SAFETY INSTRUCTIONS

- Carefully read and follow all safety signs on the machine and all safety messages in this manual.
- Safety signs should be installed, maintained and replaced when necessary.
 - If a safety sign or this manual is damaged or missing, order a replacement from your authorized dealer in the same way you order other replacement parts (be sure to state machine model and serial number when ordering).
- Learn how to operate the machine and its controls correctly and safely.
- Allow only trained, qualified, authorized personnel to operate the machine.
- Keep your machine in proper working condition.
 - Unauthorized modifications of the machine may impair its function and/or safety and affect machine life.
 - Do not modify any machine parts without authorization. Failure to do so may deteriorate the part safety, function, and/or service life. In addition, personal accident, machine trouble, and/or damage to material caused by unauthorized modifications will void Hitachi Warranty Policy.
 - Do not use attachments and/or optional parts or equipment not authorized by Hitachi. Failure to do so may deteriorate the safety, function, and/or service life of the machine. In addition, personal accident, machine trouble, and/or damage to material caused by using unauthorized attachments and/or optional parts or equipment will void Hitachi Warranty Policy.
- The safety messages in this SAFETY chapter are intended to illustrate basic safety procedures of machines. However it is impossible for these safety messages to cover every hazardous situation you may encounter. If you have any questions, you should first consult your supervisor and/or your authorized dealer before operating or performing maintenance work on the machine.

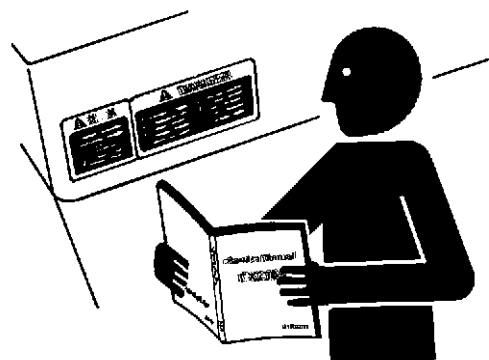

SA-003

003-E01B-0003

SAFETY

PREPARE FOR EMERGENCIES

- Be prepared if a fire starts or if an accident occurs.
 - Keep a first aid kit and fire extinguisher on hand.
 - Thoroughly read and understand the label attached on the fire extinguisher to use it properly.
 - To ensure that a fire extinguisher can be always used when necessary, check and service the fire extinguisher at the recommended intervals as specified in the fire extinguisher manual.
 - Establish emergency procedure guidelines to cope with fires and accidents.
 - Keep emergency numbers for doctors, ambulance service, hospital, and fire department posted near your telephone.



SA-437

004-E01A-0437

WEAR PROTECTIVE CLOTHING

- Wear close fitting clothing and safety equipment appropriate to the job.

You may need:

- A hard hat
- Safety shoes
- Safety glasses, goggles, or face shield
- Heavy gloves
- Hearing protection
- Reflective clothing
- Wet weather gear
- Respirator or filter mask.

Be sure to wear the correct equipment and clothing for the job. Do not take any chances.

- Avoid wearing loose clothing, jewelry, or other items that can catch on control levers or other parts of the machine.
- Operating equipment safely requires the full attention of the operator. Do not wear radio or music headphones while operating the machine.

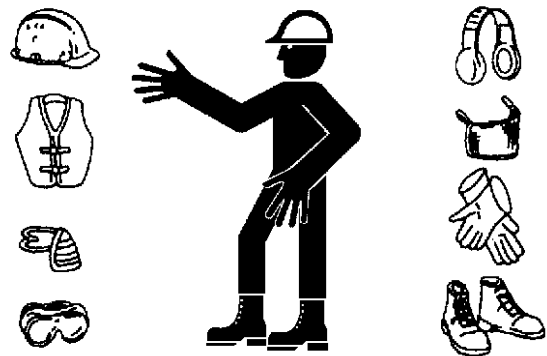

SA-438

005-E01A-0438

PROTECT AGAINST NOISE

- Prolonged exposure to loud noise can cause impairment or loss of hearing.
 - Wear a suitable hearing protective device such as earmuffs or earplugs to protect against objectionable or uncomfortably loud noises.



006-E01A-0434

SA-434

SAFETY

INSPECT MACHINE

- Inspect your machine carefully each day or shift by walking around it before you start it to avoid personal injury.
- In the walk-around inspection be sure to cover all points described in the "PRE-START INSPECTION" chapter in the operator's manual.



SA-435

GENERAL PRECAUTIONS FOR CAB

- Before entering the cab, thoroughly remove all dirt and/or oil such as mud, grease, soil or stones that may mess up the cab from the soles of your work boots. If any controls such as a pedal is operated while with dirt and/or oil on the soles of the operator's work boots the operator's foot may slip off the pedal, possibly resulting in a personal accident.
- Do not mess up around the operator's seat with parts, tools, soil, stones, obstacles that may fold up or turn over, cans or lunch box. The levers or pedals become inoperable if obstacle jams in operation stroke of the travel levers/pedals, pilot control shut-off lever or control levers, which may result in serious injury or death.
- Avoid storing transparent bottles in the cab. Do not attach any transparent type window decorations on the windowpanes as they may focus sunlight, possibly starting a fire.
- Refrain from listening to the radio, or using music headphones or mobile telephones in the cab while operating the machine.
- Keep all flammable objects and/or explosives away from the machine.
- After using the ashtray, always cover it to extinguish the match and/or tobacco.
- Do not leave cigarette lighters in the cab. When the temperature in the cab increases, the lighter may explode.
- Use proper floor mat dedicated to the machine. If another floor mat is used, it may be displaced and contact with the travel pedals during operation, resulting in serious injury or death.

524-E01A-0000

SAFETY

USE HANDHOLDS AND STEPS

- Falling is one of the major causes of personal injury.
 - When you get on and off the machine, always face the machine and maintain a three-point contact with the steps and handrails.
 - Do not use any controls as hand-holds.
 - Never jump on or off the machine. Never mount or dismount a moving machine.
 - Be careful of slippery conditions on platforms, steps, and handrails when leaving the machine.

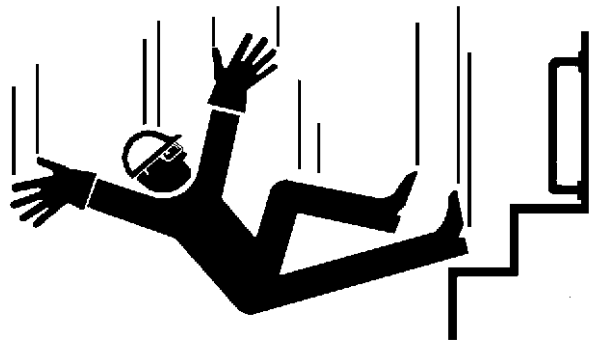

008-E01A-0439

SA-439

ADJUST THE OPERATOR'S SEAT

- A poorly adjusted seat for either the operator or for the work at hand may quickly fatigue the operator leading to misoperations.
 - The seat should be adjusted whenever changing the operator for the machine.
 - The operator should be able to fully depress the pedals and to correctly operate the control levers with his back against the seat back.
 - If not, move the seat forward or backward, and check again.
 - Adjust the rear view mirror position so that the best rear visibility is obtained from the operator's seat. If the mirror is broken, immediately replace it with a new one.



009-E01A-0462

SA-378

ENSURE SAFETY BEFORE RISING FROM OR LEAVING OPERATOR'S SEAT

- Before rising from the operator's seat to open/close either side window or to adjust the seat position, be sure to first lower the front attachment to the ground and then move the pilot control shut-off lever to the LOCK position. Failure to do so may allow the machine to unexpectedly move when a body part unintentionally comes in contact with a control lever, possibly resulting in serious personal injury or death.
- Before leaving the machine, be sure to first lower the front attachment to the ground and then move the pilot control shut-off lever to the LOCK position. Turn the key switch OFF to stop the engine.
- Before leaving the machine, close all windows, doors, and access covers and lock them up.

SAFETY

FASTEN YOUR SEAT BELT

- If the machine should overturn, the operator may become injured and/or thrown from the cab. Additionally the operator may be crushed by the overturning machine, resulting in serious injury or death.
- Prior to operating the machine, thoroughly examine webbing, buckle and attaching hardware. If any item is damaged or worn, replace the seat belt or component before operating the machine.
- Be sure to remain seated with the seat belt securely fastened at all times when the machine is in operation to minimize the chance of injury from an accident.
- We recommend that the seat belt be replaced every three years regardless of its apparent condition.

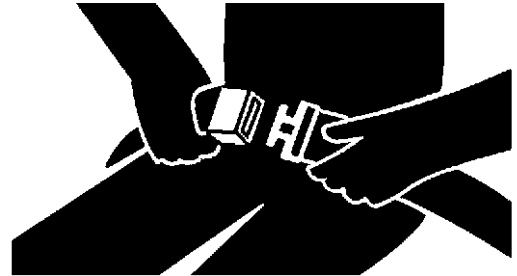

SA-237

010-E01A-0237

MOVE AND OPERATE MACHINE SAFELY

- Bystanders can be run over.
- Take extra care not to run over bystanders. Confirm the location of bystanders before moving, swinging, or operating the machine.
- Always keep the travel alarm and horn in working condition (if equipped). It warns people when the machine starts to move.
- Use a signal person when moving, swinging, or operating the machine in congested areas. Coordinate hand signals before starting the machine.
- Use appropriate illumination. Check that all lights are operable before operating the machine. If any faulty illumination is present, immediately repair it.

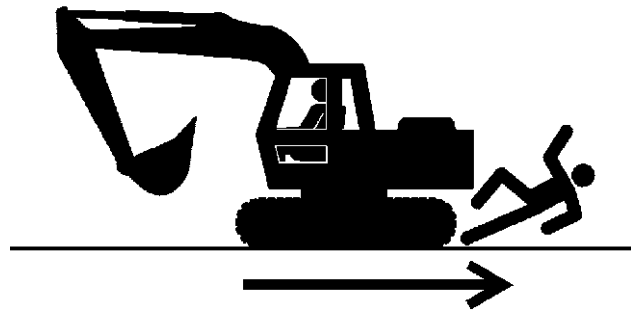

SA-426

011-E01A-0398

HANDLE STARTING AIDS SAFELY

Starting fluid:

- Starting fluid is highly flammable.
- Keep all sparks and flame away when using it.
- Keep starting fluid well away from batteries and cables.
- Remove container from machine if engine does not need starting fluid.
- To prevent accidental discharge when storing a pressurized container, keep the cap on the container, and store it in a cool, well-protected location.
- Do not incinerate or puncture a starting fluid container.



SA-293

036-E01A-0293-3

SAFETY

OPERATE ONLY FROM OPERATOR'S SEAT

- Inappropriate engine starting procedures may cause the machine to runaway, possibly resulting in serious injury or death.
 - Start the engine only when seated in the operator's seat.
 - NEVER start the engine while standing on the track or on ground.
 - Do not start engine by shorting across starter terminals.
 - Before starting the engine, confirm that all control levers are in neutral.
 - Before starting the engine, confirm the safety around the machine and sound the horn to alert bystanders.



SA-444

012-E01B-0431

JUMP STARTING

- Battery gas can explode, resulting in serious injury.
 - If the engine must be jump started, be sure to follow the instructions shown in the "OPERATING THE ENGINE" chapter in the operator's manual.
 - The operator must be in the operator's seat so that the machine will be under control when the engine starts. Jump starting is a two-person operation.
 - Never use a frozen battery.
 - Failure to follow correct jump starting procedures could result in a battery explosion or a runaway machine.

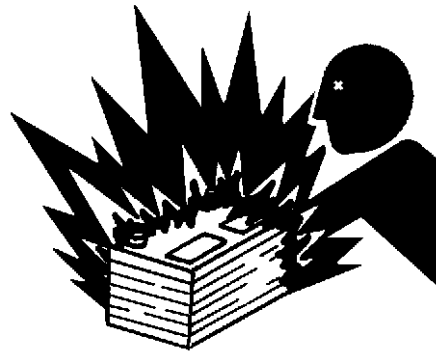

SA-032

S013-E01A-0032

KEEP RIDERS OFF MACHINE

- Riders on machine are subject to injury such as being struck by foreign objects and being thrown off the machine.
 - Only the operator should be on the machine. Keep riders off.
 - Riders also obstruct the operator's view, resulting in the machine being operated in an unsafe manner.



014-E01B-0427

SA-379

SAFETY

PRECAUTIONS FOR OPERATIONS

- Investigate the work site before starting operations.
- Be sure to wear close fitting clothing and safety equipment appropriate for the job, such as a hard hat, etc. when operating the machine.
- Clear all persons and obstacles from area of operation and machine movement.
Always beware of the surroundings while operating.
When working in a small area surrounded by obstacles, take care not to hit the upperstructure against obstacles.
- When loading onto trucks, bring the bucket over the truck beds from the rear side. Take care not to swing the bucket over the cab or over any person.

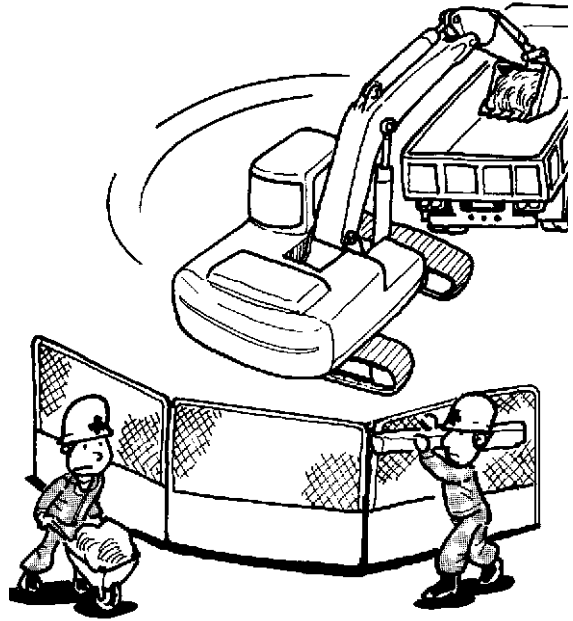

M178-05-007

SAFETY

INVESTIGATE JOB SITE BEFOREHAND

- When working at the edge of an excavation or on a road shoulder, the machine could tip over, possibly resulting in serious injury or death.
 - Investigate the configuration and ground conditions of the job site beforehand to prevent the machine from falling and to prevent the ground, stockpiles, or banks from collapsing.
 - Make a work plan. Use machines appropriate to the work and job site.
 - Reinforce ground, edges, and road shoulders as necessary. Keep the machine well back from the edges of excavations and road shoulders.
 - When working on an incline or on a road shoulder, employ a signal person as required.
 - Confirm that your machine is equipped a FOPS cab before working in areas where the possibility of falling stones or debris exist.
 - When the footing is weak, reinforce the ground before starting work.
 - When working on frozen ground, be extremely alert. As ambient temperatures rise, footing becomes loose and slippery.
 - Beware the possibility of fire when operating the machine near flammable objects such as dry grass.
- Make sure the work site has sufficient strength to firmly support the machine.

When working close to an excavation or at road shoulders, operate the machine with the tracks positioned perpendicular to the cliff face with travel motors at the rear, so that the machine can more easily evacuate if the cliff face collapses.
- If working on the bottom of a cliff or a high bank is required, be sure to investigate the area first and confirm that no danger of the cliff or bank collapsing exists. If any possibility of cliff or bank collapsing exists, do not work on the area.
- Soft ground may collapse when operating the machine on it, possibly causing the machine to tip over. When working on soft ground is required, be sure to reinforce the ground first using large pieces of steel plates strong and firm enough to easily support the machine.
- Note that there is always a possibility of machine tipping over when working on rough terrain or on slopes. Prevent machine tipping over from occurring. When operating on rough terrain or on slopes:
 - Reduce the engine speed.
 - Select slow travel speed mode.
 - Operate the machine slowly and be cautious with machine movements.

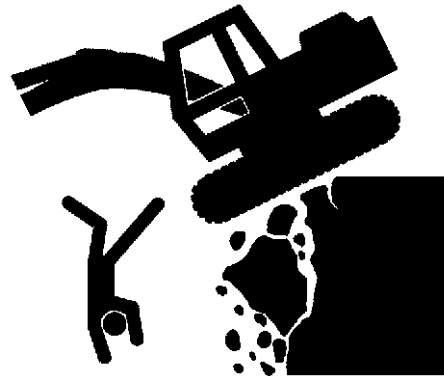

SA-380

SAFETY

EQUIPMENT OF HEAD GUARD, ROPS, FOPS

In case the machine is operated in areas where the possibility of falling stones or debris exist, equip a head guard, ROPS, or FOPS according to the potential hazardous conditions. (The standard cab for this machine corresponds to ROPS and FOPS.)

ROPS: Roll-Over Protective Structure
FOPS: Falling Object Protective Structure

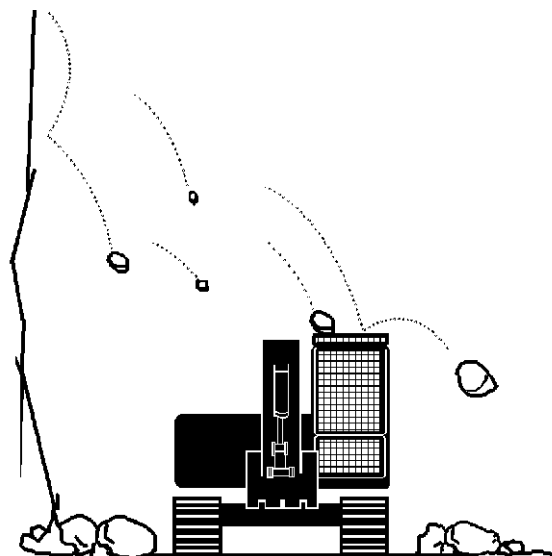

SA-490

PROVIDE SIGNALS FOR JOBS INVOLVING MULTIPLE NUMBERS OF MACHINES

- For jobs involving multiple numbers of machines, provide signals commonly known by all personnel involved. Also, appoint a signal person to coordinate the job site. Make sure that all personnel obey the signal person's directions.



018-E01A-0481

SA-481

CONFIRM DIRECTION OF MACHINE TO BE DRIVEN

- Incorrect travel pedal/lever operation may result in serious injury death.
- Before driving the machine, confirm the position of the undercarriage in relation to the operator's position. If the travel motors are located in front of the cab, the machine will move in reverse when travel pedals/levers are operated to the front.

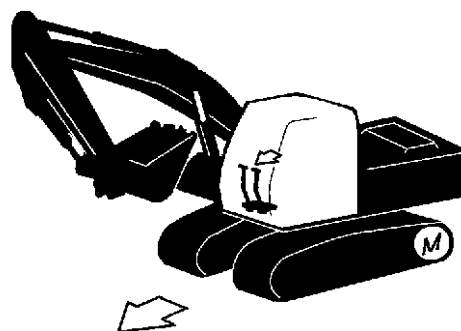

017-E01A-0491

SA-491

SAFETY

DRIVE MACHINE SAFELY

- Before driving the machine, always confirm that the travel levers/pedals direction corresponds to the direction you wish to drive.
 - Be sure to detour around any obstructions.
 - Avoid traveling over obstructions. Soil, fragments of rocks, and/or metal pieces may scatter around the machine. Do not allow personnel to stay around the machine while traveling.
- Driving on a slope may cause the machine to slip or overturn, possibly resulting in serious injury or death.
 - Never attempt to ascend or descend 35 degrees or steeper slopes.
 - Be sure to fasten the seat belt.
 - When driving up or down a slope, keep the bucket facing the direction of travel, approximately 0.5 to 1.0 m (A) above the ground.
 - If the machine starts to skid or becomes unstable, immediately lower the bucket to the ground and stop.
 - Driving across the face of a slope or steering on a slope may cause the machine to skid or turnover. If the direction must be changed, move the machine to level ground, then, change the direction to ensure safe operation.
 - Avoid swinging the upperstructure on slopes. Never attempt to swing the upperstructure downhill. The machine may tip over. If swinging uphill is unavoidable, carefully operate the upperstructure and boom at slow speed.
 - If the engine stalls on a slope, immediately lower the bucket to the ground. Return the control levers to neutral. Then, restart the engine.
 - Be sure to thoroughly warm up the machine before ascending steep slopes. If hydraulic oil has not warmed up sufficiently, sufficient performance may not be obtained.

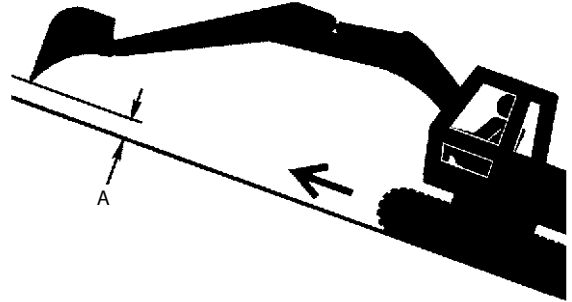

SA-657

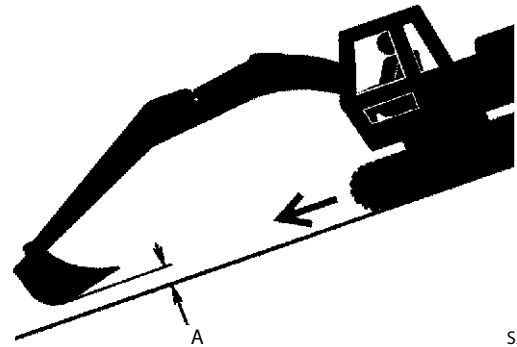

SA-658

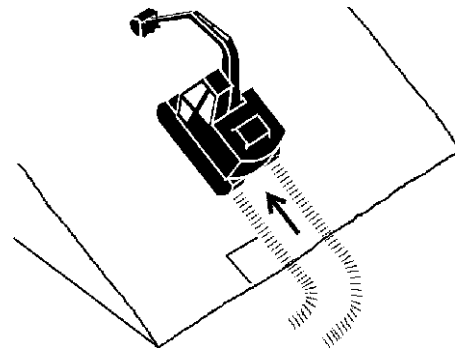

SA-441

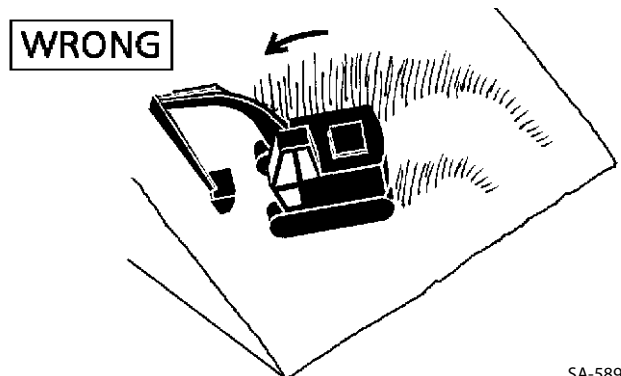

SA-589

SAFETY

- Use a signal person when moving, swinging or operating the machine in congested areas. Coordinate hand signals before starting the machine.
- Before moving machine, determine which way to move travel pedals/levers for the direction you want to go. When the travel motors are in the rear, pushing down on the front of the travel pedals or pushing the levers forward moves the machine forward, towards the idlers. An arrow-mark seal is stuck on the inside surface of the side frame to indicate the machine front direction.
- Select a travel route that is as flat as possible. Steer the machine as straight as possible, making small gradual changes in direction.
- Before traveling on them, check the strengths of bridges and road shoulders, and reinforce if necessary.
- Use wood plates in order not to damage the road surface. Be careful of steering when operating on asphalt roads in summer.
- When crossing train tracks, use wood plates in order not to damage them.
- Do not make contact with electric wires or bridges.
- When crossing a river, measure the depth of the river using the bucket, and cross slowly. Do not cross the river when the depth of the river is deeper than the upper edge of the upper roller.
- When traveling on rough terrain, reduce engine speed. Select slow travel speed. Slower speed will reduce possible damage to the machine.
- Avoid operations that may damage the track and undercarriage components.
- During freezing weather, always clean snow and ice from track shoes before loading and unloading machine, to prevent the machine from slipping.

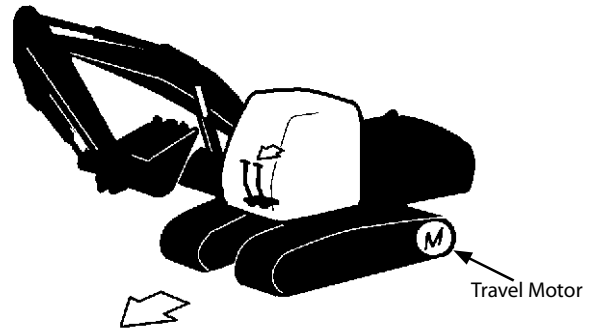

M104-05-008

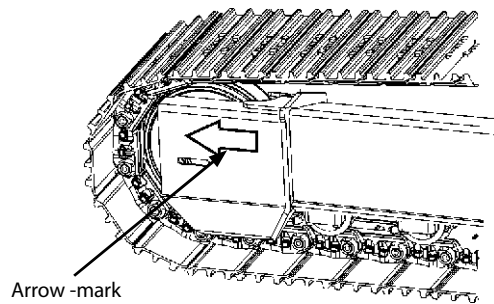

M178-03-001

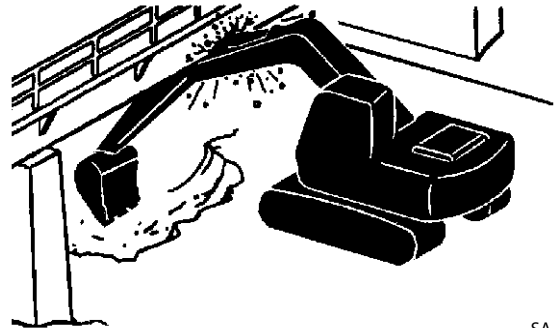

SA-011

SAFETY

AVOID INJURY FROM ROLLAWAY ACCIDENTS

- Death or serious injury may result if you attempt to mount or stop a moving machine.

To avoid rollaways:

- Select level ground when possible to park the machine.
- Do not park the machine on a grade.
- Lower the bucket and/or other work tools to the ground.
- Turn the auto-idle switch OFF.
- Run the engine at slow idle speed without load for 5 minutes to cool down the engine.
- Stop the engine and remove the key from the key switch.
- Pull the pilot control shut-off lever to LOCK position.
- Block both tracks and lower the bucket to the ground. Thrust the bucket teeth into the ground if you must park on a grade.
- Position the machine to prevent rolling.
- Park a reasonable distance from other machines.

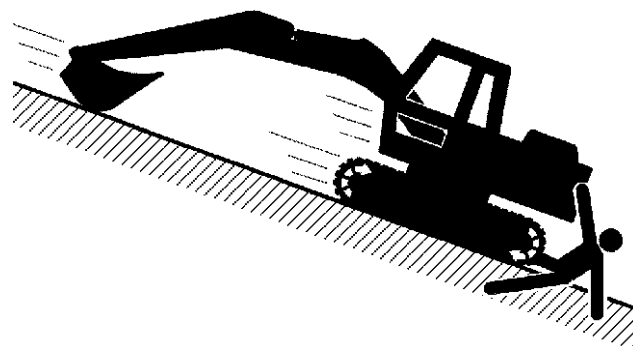

SA-391

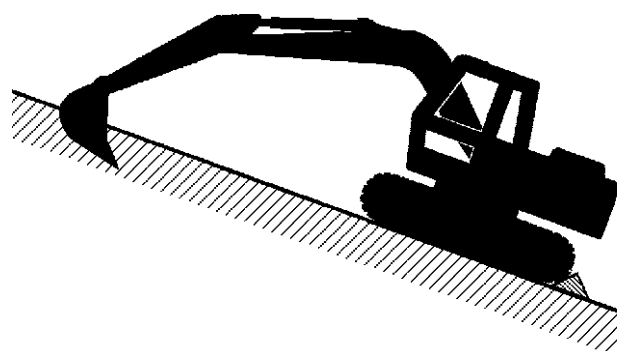

SA-392

020-E02A-0493

SAFETY

AVOID INJURY FROM BACK-OVER AND SWING ACCIDENTS

- If any person is present near the machine when backing or swinging the upperstructure, the machine may hit or run over that person, resulting in serious injury or death.

To avoid back-over and swing accidents:

- Always look around **BEFORE YOU BACK UP AND SWING THE MACHINE**. BE SURE THAT ALL BYSTANDERS ARE CLEAR.
- Keep the travel alarm in working condition (if equipped). ALWAYS BE ALERT FOR BYSTANDERS MOVING INTO THE WORK AREA. USE THE HORN OR OTHER SIGNAL TO WARN BYSTANDERS BEFORE MOVING MACHINE.
- USE A SIGNAL PERSON WHEN BACKING UP IF YOUR VIEW IS OBSTRUCTED. ALWAYS KEEP THE SIGNAL PERSON IN VIEW.

Use hand signals, which conform to your local regulations, when work conditions require a signal person.

- No machine motions shall be made unless signals are clearly understood by both signalman and operator.
- Learn the meanings of all flags, signs, and markings used on the job and confirm who has the responsibility for signaling.
- Keep windows, mirrors, and lights clean and in good condition.
- Dust, heavy rain, fog, etc., can reduce visibility. As visibility decreases, reduce speed and use proper lighting.
- Read and understand all operating instructions in the operator's manual.

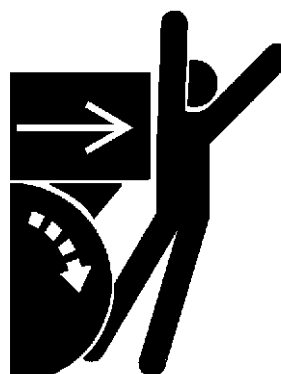

SA-383

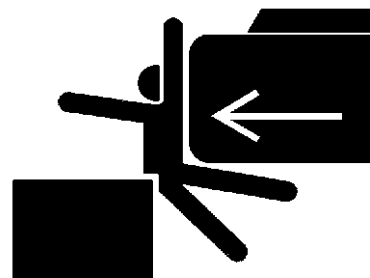

SA-384

021-E01A-0494

Thank you so much for reading.
Please click the “Buy Now!”
button below to download the
complete manual.



After you pay.

You can download the most
perfect and complete manual in
the world immediately.

Our support email:

ebooklibonline@outlook.com