

Product: SKID STEER LOADER

Model: 226B3 SKID STEER LOADER MWD

Configuration: 226B3 Skid Steer Loader MWD00001-UP (MACHINE) POWERED BY C2.2 Engine

Operation and Maintenance Manual 216B3, 226B3, 236B3, 242B3 and 252B3 Skid Steer Loaders, 247B3 and 257B3 Multi Terrain Loaders and 259B3 Compact Track Loader

Media Number -SEBU8495-14

Publication Date -01/04/2014

Date Updated -29/11/2017

s00037320

Foreword

Literature Information

This manual should be stored in the operator's compartment in the literature holder or seat back literature storage area.

This manual contains safety information, operation instructions, transportation information, lubrication information and maintenance information.

Some photographs or illustrations in this publication show details or attachments that can be different from your machine. Guards and covers might have been removed for illustrative purposes.

Continuing improvement and advancement of product design might have caused changes to your machine which are not included in this publication. Read, study and keep this manual with the machine.

Whenever a question arises regarding your machine, or this publication, please consult your Cat dealer for the latest available information.

Safety

The safety section lists basic safety precautions. In addition, this section identifies the text and locations of warning signs and labels used on the machine.

Read and understand the basic precautions listed in the safety section before operating or performing lubrication, maintenance and repair on this machine.

Operation

The operation section is a reference for the new operator and a refresher for the experienced operator. This section includes a discussion of gauges, switches, machine controls, attachment controls, transportation and towing information.

Photographs and illustrations guide the operator through correct procedures of checking, starting, operating and stopping the machine.

Operating techniques outlined in this publication are basic. Skill and techniques develop as the operator gains knowledge of the machine and its capabilities.

Maintenance

The maintenance section is a guide to equipment care. The Maintenance Interval Schedule (MIS) lists the items to be maintained at a specific service interval. Items without specific intervals are listed under the "When Required" service interval. The Maintenance Interval Schedule lists the page number for the step-by-step instructions required to accomplish the scheduled maintenance. Use the Maintenance Interval Schedule as an index or "one safe source" for all maintenance procedures.

Maintenance Intervals

Use the service hour meter to determine servicing intervals. Calendar intervals shown (daily, weekly, monthly, etc.) can be used instead of service hour meter intervals if they provide more convenient servicing schedules and approximate the indicated service hour meter reading. Recommended service should always be performed at the interval that occurs first.

Under extremely severe, dusty or wet operating conditions, more frequent lubrication than is specified in the maintenance intervals chart might be necessary.

Perform service on items at multiples of the original requirement. For example, at every 500 service hours or 3 months, also service those items listed under every 250 service hours or monthly and every 10 service hours or daily.

California Proposition 65 Warning

Diesel engine exhaust and some of its constituents are known to the State of California to cause cancer, birth defects, and other reproductive harm.

Battery posts, terminals and related accessories contain lead and lead compounds. **Wash hands after handling.**

Certified Engine Maintenance

Proper maintenance and repair is essential to keep the engine and machine systems operating correctly. As the heavy duty off-road diesel engine owner, you are responsible for the performance of the required maintenance listed in the Owner Manual, Operation and Maintenance Manual, and Service Manual.

It is prohibited for any person engaged in the business of repairing, servicing, selling, leasing, or trading engines or machines to remove, alter, or render inoperative any emission related device or element of design installed on or in an engine or machine that is in compliance with the regulations (40 CFR Part 89). Certain elements of the machine and engine such as the exhaust system, fuel system, electrical system, intake air system and cooling system may be emission related and should not be altered unless approved by Caterpillar.

Machine Capacity

Additional attachments or modifications may exceed machine design capacity which can adversely affect performance characteristics. Included would be stability and system certifications such as brakes, steering, and rollover protective structures (ROPS). Contact your Cat dealer for further information.

Cat Product Identification Number

Effective First Quarter 2001 the Cat Product Identification Number (PIN) has changed from 8 to 17 characters. In an effort to provide uniform equipment identification, Caterpillar and other construction equipment manufacturers are moving to comply with the latest version of the product identification numbering standard. Non-road machine PINs are defined by ISO 10261. The new PIN format will apply to all Cat machines and generator sets. The PIN plates and frame marking will display the 17 character PIN. The new format will look like the following:

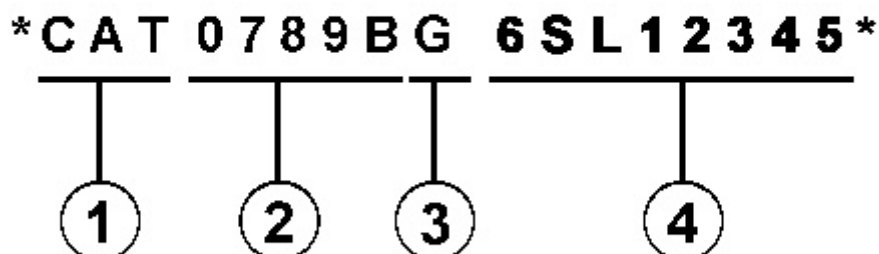

Illustration 1

g00751314

Where:

1. Caterpillar's World Manufacturing Code (characters 1-3)
2. Machine Descriptor (characters 4-8)
3. Check Character (character 9)
4. Machine Indicator Section (MIS) or Product Sequence Number (characters 10-17). These were previously referred to as the Serial Number.

Machines and generator sets produced before First Quarter 2001 will maintain their 8 character PIN format.

Components such as engines, transmissions, axles, etc. and work tools will continue to use an 8 character Serial Number (S/N).

Product: SKID STEER LOADER

Model: 226B3 SKID STEER LOADER MWD

Configuration: 226B3 Skid Steer Loader MWD00001-UP (MACHINE) POWERED BY C2.2 Engine

Operation and Maintenance Manual 216B3, 226B3, 236B3, 242B3 and 252B3 Skid Steer Loaders, 247B3 and 257B3 Multi Terrain Loaders and 259B3 Compact Track Loader

Media Number -SEBU8495-14

Publication Date -01/04/2014

Date Updated -29/11/2017

i02811655

Safety Messages - Work Tools

SMCS - 7000; 7405

There are several specific safety messages on these work tools. The exact location of the hazards and the description of the hazards are reviewed in this section. Please become familiarized with all safety messages.

Make sure that all of the safety messages are legible. Clean the safety messages or replace the safety messages if you cannot read the words. Replace the illustrations if the illustrations are not legible. When you clean the safety messages, use a cloth, water and soap. Do not use solvent, gasoline, or other harsh chemicals to clean the safety messages. Solvents, gasoline, or harsh chemicals could loosen the adhesive that secures the safety message. Loose adhesive will allow the safety message to fall.

Replace any safety message that is damaged, or missing. If a safety message is attached to a part that is replaced, install a safety message on the replacement part. Any Caterpillar dealer can provide new safety messages.

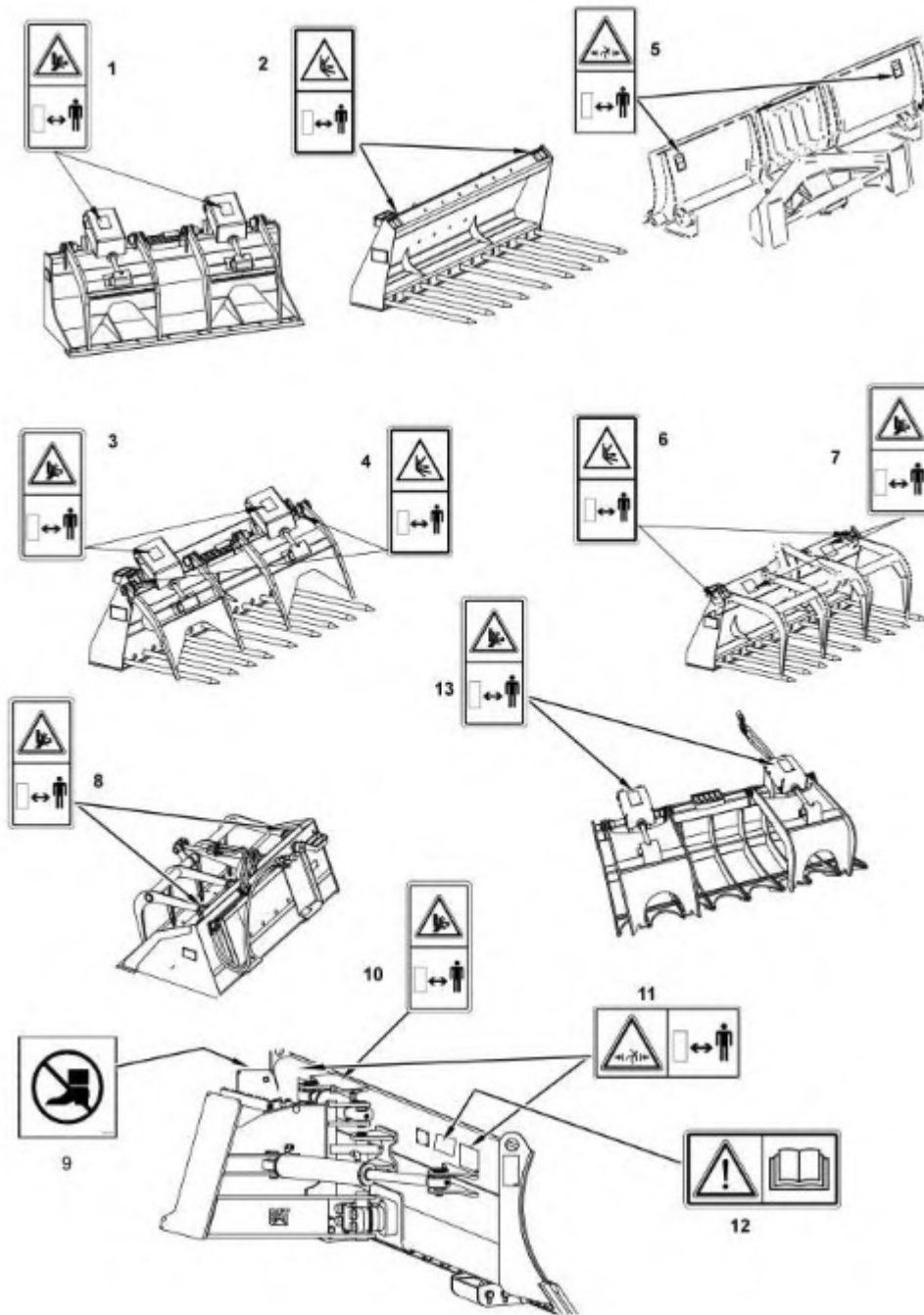

Illustration 1

g01402473

Industrial Grapple Bucket (1)

These warning messages are located on top of the guards for the grapple cylinders.



g01378775

 **WARNING**

No clearance for person in this area during operation. Severe injury or death from crushing could occur. Stay away from the work tool while it is in operation.

Utility Fork (2)

These warning messages are located on top of the fork carriage.



 **WARNING**

No clearance for person in this area during operation. Severe injury or death from impalement could occur. Stay away from the work tool while it is in operation.

Industrial Grapple Fork (3)

These warning messages are located on the guards for the grapple cylinders.



 **WARNING**

No clearance for person in this area during operation. Severe injury or death from crushing could occur. Stay away from the work tool while it is in operation.

Industrial Grapple Fork (4)

These warning messages are located on top of the fork carriage.



g01389170

 **WARNING**

No clearance for person in this area during operation. Severe injury or death from impalement could occur. Stay away from the work tool while it is in operation.

Angle Blade (5)

These warning messages are located on the back side of the blade.



 **WARNING**

No clearance for person in this area during operation. Severe injury or death from crushing could occur. Stay away from the work tool while it is in operation.

Utility Grapple Fork (6)

These warning messages are located on top of the fork carriage.



 **WARNING**

No clearance for person in this area during operation. Severe injury or death from impalement could occur. Stay away from the work tool while it is in operation.

Utility Grapple Fork (7)

These warning messages are located on top of the grapple frame.



g01378775

 **WARNING**

No clearance for person in this area during operation. Severe injury or death from crushing could occur. Stay away from the work tool while it is in operation.

Utility Grapple Bucket (8)

These warning messages are located on top of the grapple frame.



 **WARNING**

No clearance for person in this area during operation. Severe injury or death from crushing could occur. Stay away from the work tool while it is in operation.

Dozer Blade (9)

This warning message is located on top of the dozer blade.

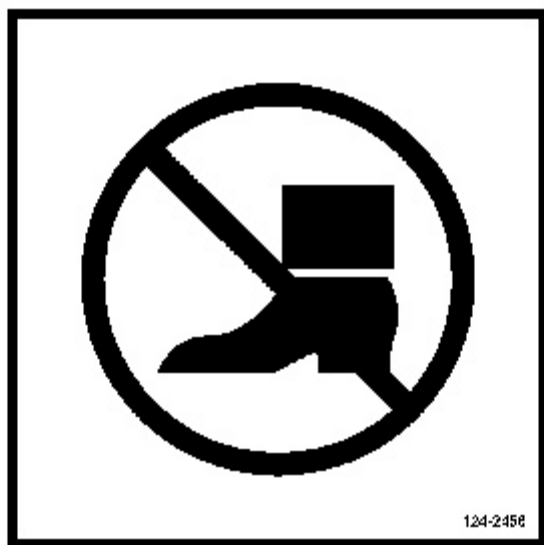

g00946617

 **WARNING**

Falling Hazard - Area may be oily and slippery. Do not step on cylinders. Serious injury or death could occur from a fall.

Dozer Blade (10)

This warning message is located on top of the dozer blade.



g01378775

 **WARNING**

No clearance for person in this area during operation. Severe injury or death from crushing could occur. Stay away from the work tool while it is in operation.

Dozer Blade (11)

These warning messages are located on the back side of the blade.

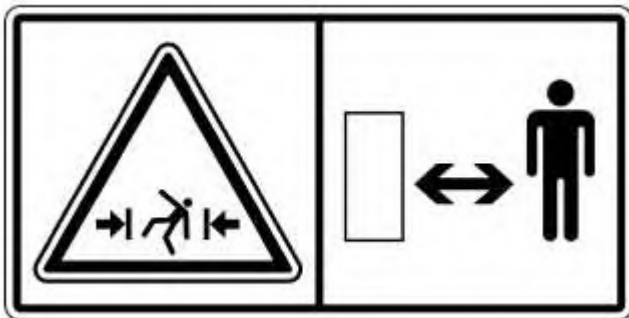

g01371644

 **WARNING**

No clearance for person in this area during operation. Severe injury or death from crushing could occur. Stay away from the work tool while it is in operation.

Dozer Blade (12)

This warning is located on right hand side on the back of the blade.



g01370904

 **WARNING**

DO NOT OPERATE OR WORK ON THIS MACHINE UNLESS YOU HAVE READ AND UNDERSTAND THE INSTRUCTIONS AND WARNINGS IN THE OPERATION AND MAINTENANCE MANUALS. FAILURE TO FOLLOW THE INSTRUCTIONS OR HEED THE WARNINGS COULD RESULT IN INJURY OR DEATH. CONTACT ANY CATERPILLAR DEALER FOR REPLACEMENT MANUALS. PROPER CARE IS YOUR RESPONSIBILITY.

Grapple Rake (13)

These warning messages are located on top of the grapple frame.



g01378775

 **WARNING**

No clearance for person in this area during operation. Severe injury or death from crushing could occur. Stay away from the work tool while it is in operation.

Product: SKID STEER LOADER

Model: 226B3 SKID STEER LOADER MWD

Configuration: 226B3 Skid Steer Loader MWD00001-UP (MACHINE) POWERED BY C2.2 Engine

Operation and Maintenance Manual

216B3, 226B3, 236B3, 242B3 and 252B3 Skid Steer Loaders, 247B3 and 257B3 Multi Terrain Loaders and 259B3 Compact Track Loader

Media Number -SEBU8495-14

Publication Date -01/04/2014

Date Updated -29/11/2017

i03878962

Safety Messages

SMCS - 7000; 7405

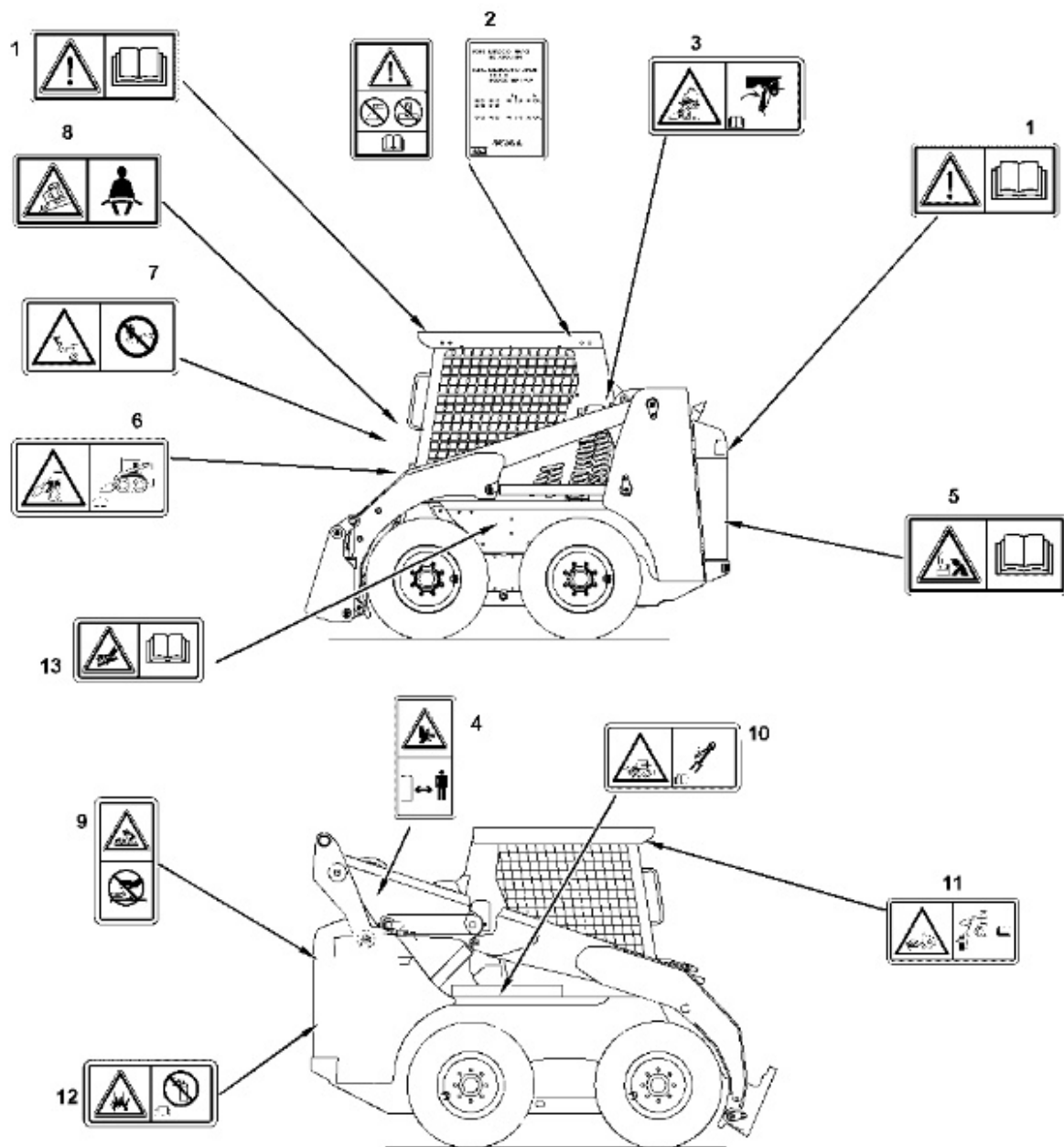

Illustration 1

g02125620

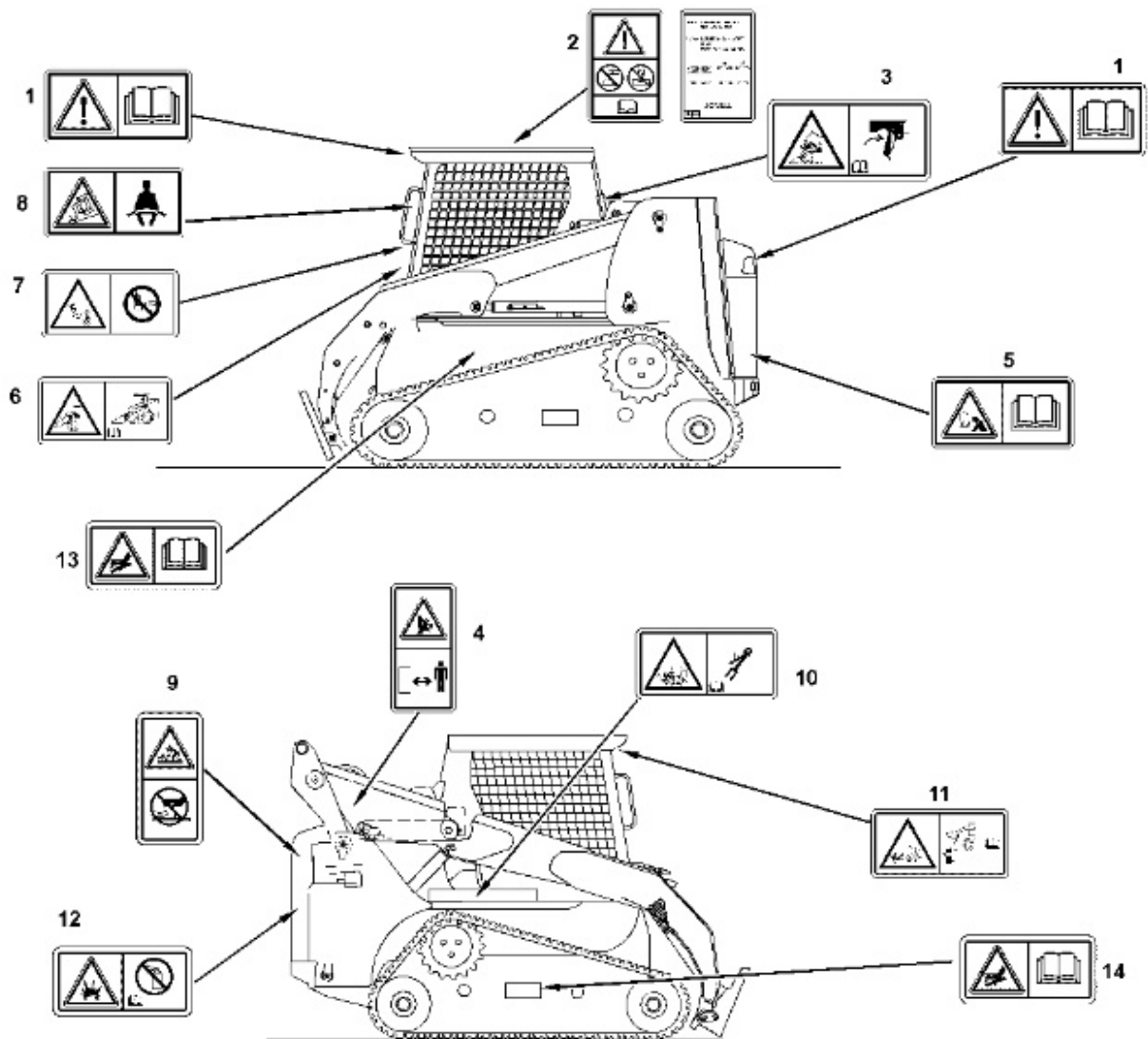

Illustration 2

g02125630

There are several specific safety messages on this machine. The exact location of the hazards and the description of the hazards are reviewed in this section. Please become familiarized with all safety messages.

Make sure that all of the safety messages are legible. Clean the safety messages or replace the safety messages if you cannot read the words. Replace the illustrations if the illustrations are not legible. When you clean the safety messages, use a cloth, water and soap. Do not use solvent, gasoline, or other harsh chemicals to clean the safety messages. Solvents, gasoline, or harsh chemicals could loosen the adhesive that secures the safety message. Loose adhesive will allow the safety message to fall.

Replace any safety message that is damaged, or missing. If a safety message is attached to a part that is replaced, install a safety message on the replacement part. Any Caterpillar dealer can provide new safety messages.

Do Not Operate (1)

This warning message is located inside the cab on the upper left side. This warning message is located also on the engine.



Illustration 3

g01370904



Read and understand the instructions and warnings in the operation and maintenance manuals. Contact any Caterpillar dealer for replacement manuals. Proper care is your responsibility.

Be alert! Know work conditions. Note and avoid all hazards and obstructions. Keep by-standers away when operating.

Fasten seat belt and lower armrest.

Make certain all controls are in neutral position and start engine.

Disengage parking brake.

Machine controls are active.

Failure to follow the instructions or heed the warnings could result injury or death.

Rollover Protective Structure/Falling Object Protective Structure (2)

This warning film and the certification film are located inside the cab on the upper left side.



Illustration 4

g01211895



Structural damage, an overturn, modification, alteration, or improper repair can impair this structure's protection capability thereby voiding this certification. Do not weld on or drill holes in the structure. Consult a Caterpillar dealer to determine this structure's limitations without voiding its certification.

This machine has been certified to the standards that are listed on the certification plate. The maximum mass of the machine, which includes the operator and the attachments without a payload, should not exceed the mass on the certification film.

Cab Support (3)

This warning message is located on the left side of the machine near the cab support lever. This warning message is also located inside the cab on the lower left side.

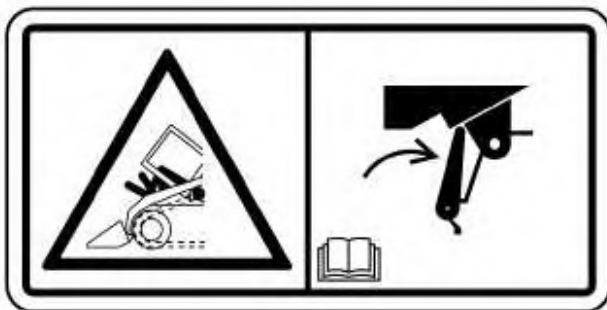

Illustration 5

g01427440



Do not go beneath cab unless cab is empty and support lever is engaged.

Failure to follow the instructions or heed the warnings could result in injury or death.

Crush Hazard (4)

This warning is located on both of the loader arms of the machines that are equipped with extended reach.



Illustration 6

g01378775



No clearance for person in this area during operation. Severe injury or death from crushing could occur. Stay away from the work tool while it is in operation.

Batteries (5)

This warning message is located on the inside of the engine access door.

Thank you so much for reading.
Please click the “Buy Now!”
button below to download the
complete manual.



After you pay.

You can download the most
perfect and complete manual in
the world immediately.

Our support email:

ebooklibonline@outlook.com