

Product: MULTI TERRAIN LOADER

Model: 277D MULTI TERRAIN LOADER MLT

Configuration: 277D Multi Terrain Loader MLT00001-UP (MACHINE) POWERED BY C3.3B Engine

## **Operation and Maintenance Manual D-Series and D2-Series Compact Track Loaders (CTL), Multi-Terrain Loaders (MTL), and Skid Steer Loaders (SSL)**

Media Number -SEBU9084-18

Publication Date -01/05/2015

Date Updated -11/07/2018

s03548206

## **Foreword**

### **California Proposition 65 Warning**

**Diesel engine exhaust and some of its constituents are known to the State of California to cause cancer, birth defects, and other reproductive harm.**



**WARNING** - This product can expose you to chemicals including ethylene glycol, which is known to the State of California to cause birth defects or other reproductive harm. For more information go to:

[www.P65Warnings.ca.gov](http://www.P65Warnings.ca.gov)

**Do not ingest this chemical. Wash hands after handling to avoid incidental ingestion.**



**WARNING** - This product can expose you to chemicals including lead and lead compounds, which are known to the State of California to cause cancer, birth defects, or other reproductive harm. For more information go to:

[www.P65Warnings.ca.gov](http://www.P65Warnings.ca.gov)

**Wash hands after handling components that may contain lead.**

## **Literature Information**

This manual should be stored in the operator's compartment in the literature holder or seat back literature storage area.

This manual contains safety information, operation instructions, transportation information, lubrication information, and maintenance information.

Some photographs or illustrations in this publication show details or attachments that can be different from your machine. Guards and covers might have been removed for illustrative purposes.

Continuing improvement and advancement of product design might have caused changes to your machine which are not included in this publication. Read, study, and keep this manual with the machine.

Whenever a question arises regarding your machine, or this publication, please consult your Cat dealer for the latest available information.

## **Safety**

The safety section lists basic safety precautions. In addition, this section identifies the text and locations of warning signs and labels used on the machine.

Read and understand the basic precautions listed in the safety section before operating or performing lubrication, maintenance, and repair on this machine.

## **Operation**

The operation section is a reference for the new operator and a refresher for the experienced operator. This section includes a discussion of gauges, switches, machine controls, attachment controls, transportation, and towing information.

Photographs and illustrations guide the operator through correct procedures of checking, starting, operating, and stopping the machine.

Operating techniques outlined in this publication are basic. Skill and techniques develop as the operator gains knowledge of the machine and its capabilities.

## **Maintenance**

The maintenance section is a guide to equipment care. The Maintenance Interval Schedule (MIS) lists the items to be maintained at a specific service interval. Items without specific intervals are listed under the "When Required" service interval. The Maintenance Interval Schedule lists the page number for the step-by-step instructions required to accomplish the scheduled maintenance. Use the Maintenance Interval Schedule as an index or "one safe source" for all maintenance procedures.

### **Maintenance Intervals**

Use the service hour meter to determine servicing intervals. Calendar intervals shown (daily, weekly, monthly, etc.) can be used instead of service hour meter intervals if the calendar intervals

provide more convenient servicing schedules and approximate the indicated service hour meter reading. Perform the recommended service at the interval that occurs first.

Under severe, dusty, or wet operating conditions, more frequent lubrication than is specified in the maintenance intervals chart might be necessary.

Perform service on items at multiples of the original requirement. For example, at every 500 service hours or 3 months, also service those items listed under every 250 service hours or monthly and every 10 service hours or daily.

## Certified Engine Maintenance

Proper maintenance and repair are essential to keep the engine and machine systems operating correctly. As the heavy-duty off-road diesel engine owner, you are responsible for the performance of the required maintenance listed in the Owner Manual, Operation and Maintenance Manual, and Service Manual.

It is prohibited for any person engaged in the business of repairing, servicing, selling, leasing, or trading engines or machines to remove, alter, or to render inoperative, any emission-related device or element of design installed on or in an engine or machine that is in compliance with all applicable regulations of the intended country to which it has been shipped. Certain elements of the machine and engine such as the exhaust system, fuel system, electrical system, intake air system, and cooling system may be emission-related and should not be altered unless approved by Caterpillar.

## Machine Capacity

Additional attachments or modifications may exceed machine design capacity which can adversely affect performance characteristics. Included would be stability and system certifications such as brakes, steering, and rollover protective structures (ROPS). Contact your Cat dealer for further information.

## Product Identification Number

Effective First Quarter 2001 the Product Identification Number (PIN) has changed from 8 to 17 characters. To provide uniform equipment identification, construction equipment manufacturers are moving to comply with the latest version of the product identification numbering standard. Non-road machine PINs are defined by ISO 10261. The new PIN format will apply to all machines and generator sets. The PIN plates and frame marking will display the 17 character PIN. The new format will look like the following:



Where:

1. World Manufacturing Code (characters 1-3)
2. Machine Descriptor (characters 4-8)
3. Check Character (character 9)
4. Machine Indicator Section (MIS) or Product Sequence Number (characters 10-17). These were previously referred to as the Serial Number.

Machines and generator sets produced before First Quarter 2001 will maintain their 8 character PIN format.

Components such as engines, transmissions, axles, and work tools will continue to use an 8 character Serial Number (S/N).

---

Product: MULTI TERRAIN LOADER

Model: 277D MULTI TERRAIN LOADER MLT

Configuration: 277D Multi Terrain Loader MLT00001-UP (MACHINE) POWERED BY C3.3B Engine

## **Operation and Maintenance Manual D-Series and D2-Series Compact Track Loaders (CTL), Multi-Terrain Loaders (MTL), and Skid Steer Loaders (SSL)**

Media Number -SEBU9084-18

Publication Date -01/05/2015

Date Updated -11/07/2018

i05840662

### **Safety Messages - Only Japanese market**

SMCS - 7000; 7405

There are several specific safety messages on this machine. The exact location of the hazards and the description of the hazards are reviewed in this section. Be familiar with all safety messages.

Make sure that all of the safety messages are legible. Clean the safety messages or replace the safety messages if you cannot read the words. Replace the illustrations if the illustrations are not legible. When you clean the safety messages, use a cloth, water, and soap. Do not use solvent, gasoline, or other harsh chemicals to clean the safety messages. Solvents, gasoline, or harsh chemicals could loosen the adhesive that secures the safety message. Loose adhesive will allow the safety message to fall.

Replace any safety message that is damaged, or missing. If a safety message is attached to a part that is replaced, install a safety message on the replacement part. Any Cat dealer can provide new safety messages.

---

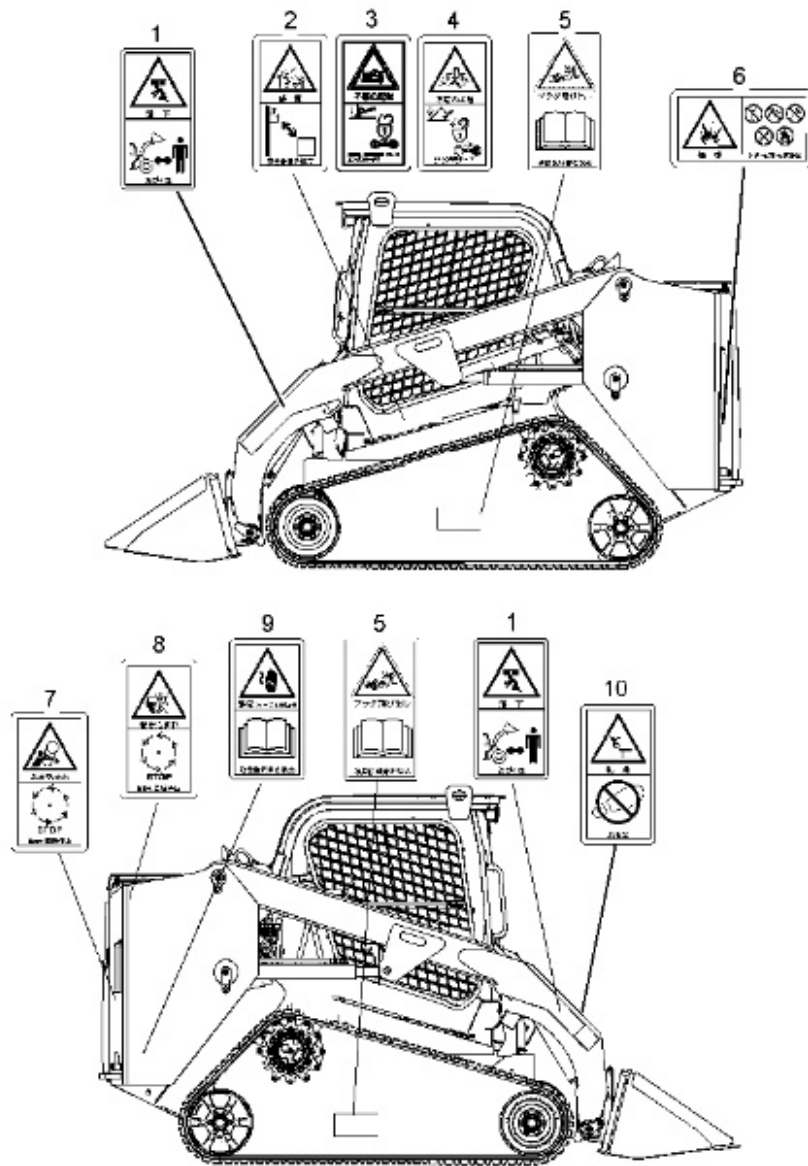

Illustration 1

g03693276

**Crushing Hazard (1)**

This safety message is located on both sides of the lift arm.



Illustration 2

g03094656



**Stay clear of the work tool during operation. Entanglement could result in personal injury or death.**

## Electrical Power Lines (2)

This safety message is Located inside cab.

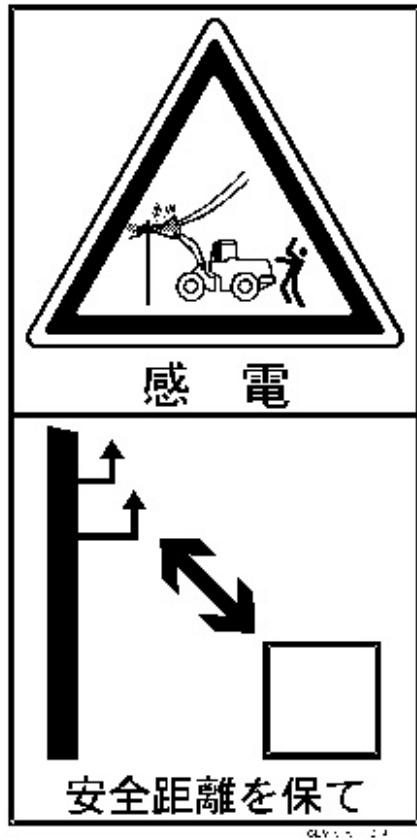

Illustration 3

g03094560



**Electrocution Hazard! Keep the machine and attachments a safe distance from electrical power. Stay clear 3 m (10 ft) plus twice the line insulator length. Read and understand the instructions and warnings in the Operation and Maintenance Manual. Failure to follow the instructions and warnings will cause serious injury or death**

### Crash Hazard (3)

This safety message is located inside cab.





---

Illustration 4

g03690403



**Stay back a safe distance. No clearance for a person in this area when the machine turns. Severe injury or death from crushing could occur.**

---

#### **Crushing Hazard (4)**

This safety message is located inside cab.

---

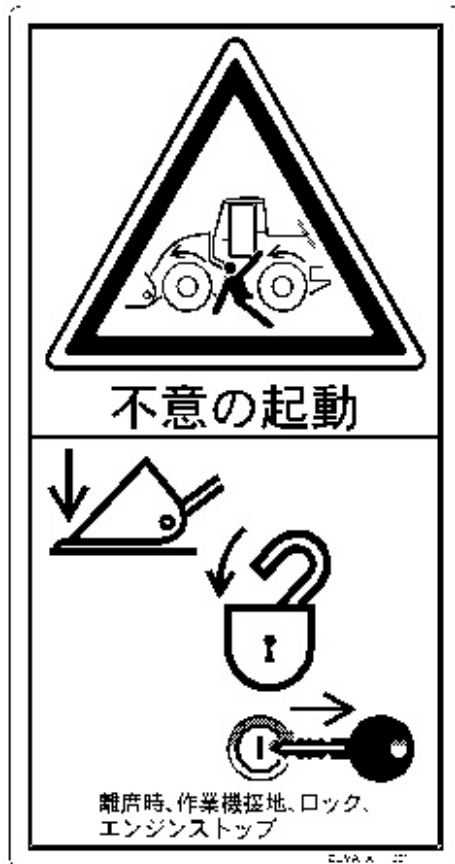

Illustration 5

g03094541

## **WARNING**

**Crush Hazard! A machine may move unexpectedly and without warning resulting in personal injury or death.**

**Before leaving the machine lower the work tool to the ground, lock operator controls, shut off the engine and remove the key.**

### **High Pressure Cylinder (5)**

This Safety message is positioned on the track adjusters.



Illustration 6

g02061296



**High Pressure Cylinder. Do not remove any parts from the cylinder until all of the pressure has been relieved. This will prevent possible personal injury or death.**

### Explosion Hazard (6)

This safety message is located at rear of the machine.



Illustration 7

g03229317



**Personal injury can result from improper troubleshooting and repair procedures.**

**The following troubleshooting and repair procedures should only be performed by qualified personnel familiar with this equipment.**

## Cutting Hazard (7)

This safety message is located at the rear of the machine.

---



Illustration 8

g02061677



**Cutting Hazard! Keep hands clear of fan while engine is running. May cause serious injury or death.**

---

## Rotating Fan (8)

This safety message is located at the rear of the machine.

---

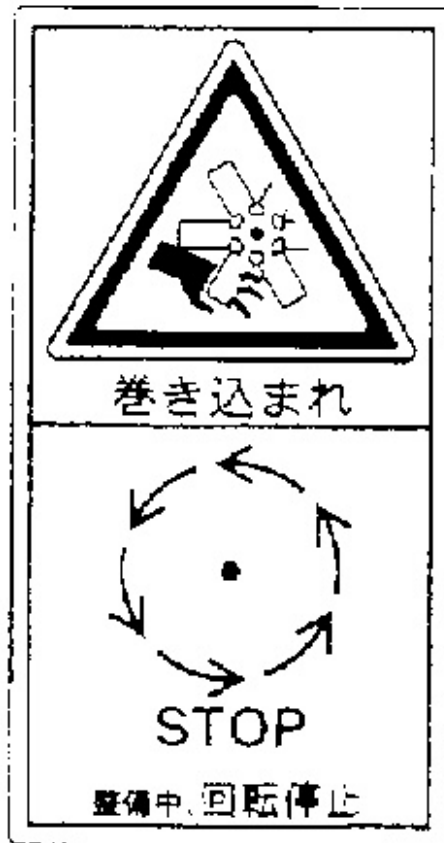

---

Illustration 9

g03369790

 **WARNING**

**Explosion Hazard! Improper jumper cable connections can cause an explosion resulting in serious injury or death. Batteries may be located in separate compartments. Refer to the Operation and Maintenance Manual for the correct jump starting procedure.**

---

**Jump Start Cables (9)**

This warning is located at rear of the machine.

---

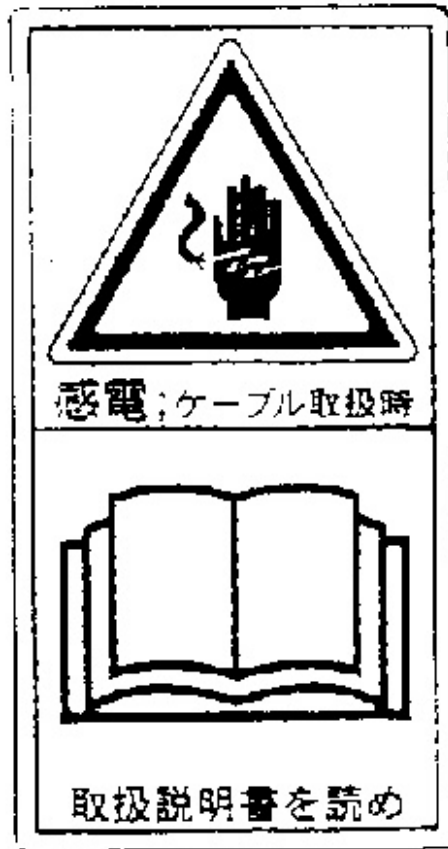

---

Illustration 10

g03369796

 **WARNING**

**Explosion Hazard! Improper jumper cable connections can cause an explosion resulting in serious injury or death. Batteries may be located in separate compartments. Refer to the Operation and Maintenance Manual for the correct jump starting procedure.**

---

**Falling Hazard (10)**

This safety message is located on lift arm.

---

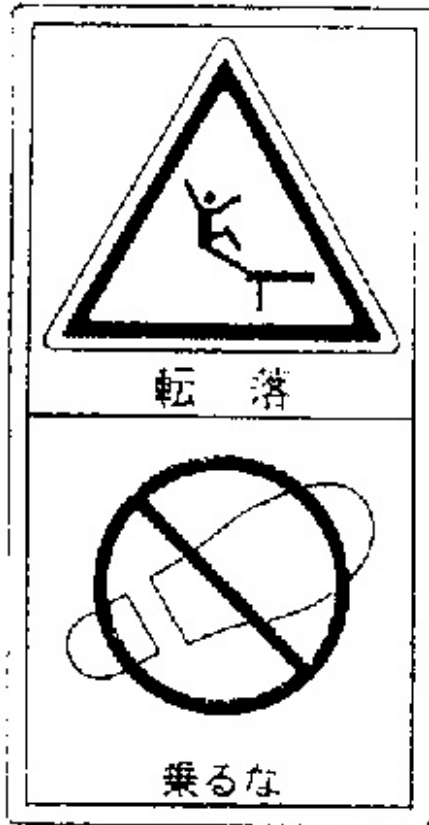

---

Illustration 11

g03369781

 **WARNING**

**Do not use this surface as a step or platform. This surface may not support additional weight or may be slippery. Serious injury or death could occur from a fall.**

---

Product: MULTI TERRAIN LOADER

Model: 277D MULTI TERRAIN LOADER MLT

Configuration: 277D Multi Terrain Loader MLT00001-UP (MACHINE) POWERED BY C3.3B Engine

## **Operation and Maintenance Manual D-Series and D2-Series Compact Track Loaders (CTL), Multi-Terrain Loaders (MTL), and Skid Steer Loaders (SSL)**

Media Number -SEBU9084-18

Publication Date -01/05/2015

Date Updated -11/07/2018

i06124054

## **Safety Messages**

SMCS - 7000; 7405

There are several specific safety messages on this machine. The exact location of the hazards and the description of the hazards are reviewed in this section. Be familiar with all safety messages.

Make sure that all of the safety messages are legible. Clean the safety messages or replace the safety messages if you cannot read the words. Replace the illustrations if the illustrations are not legible. When you clean the safety messages, use a cloth, water, and soap. Do not use solvent, gasoline, or other harsh chemicals to clean the safety messages. Solvents, gasoline, or harsh chemicals could loosen the adhesive that secures the safety message. Loose adhesive will allow the safety message to fall.

Replace any safety message that is damaged, or missing. If a safety message is attached to a part that is replaced, install a safety message on the replacement part. Any Cat dealer can provide new safety messages.

---



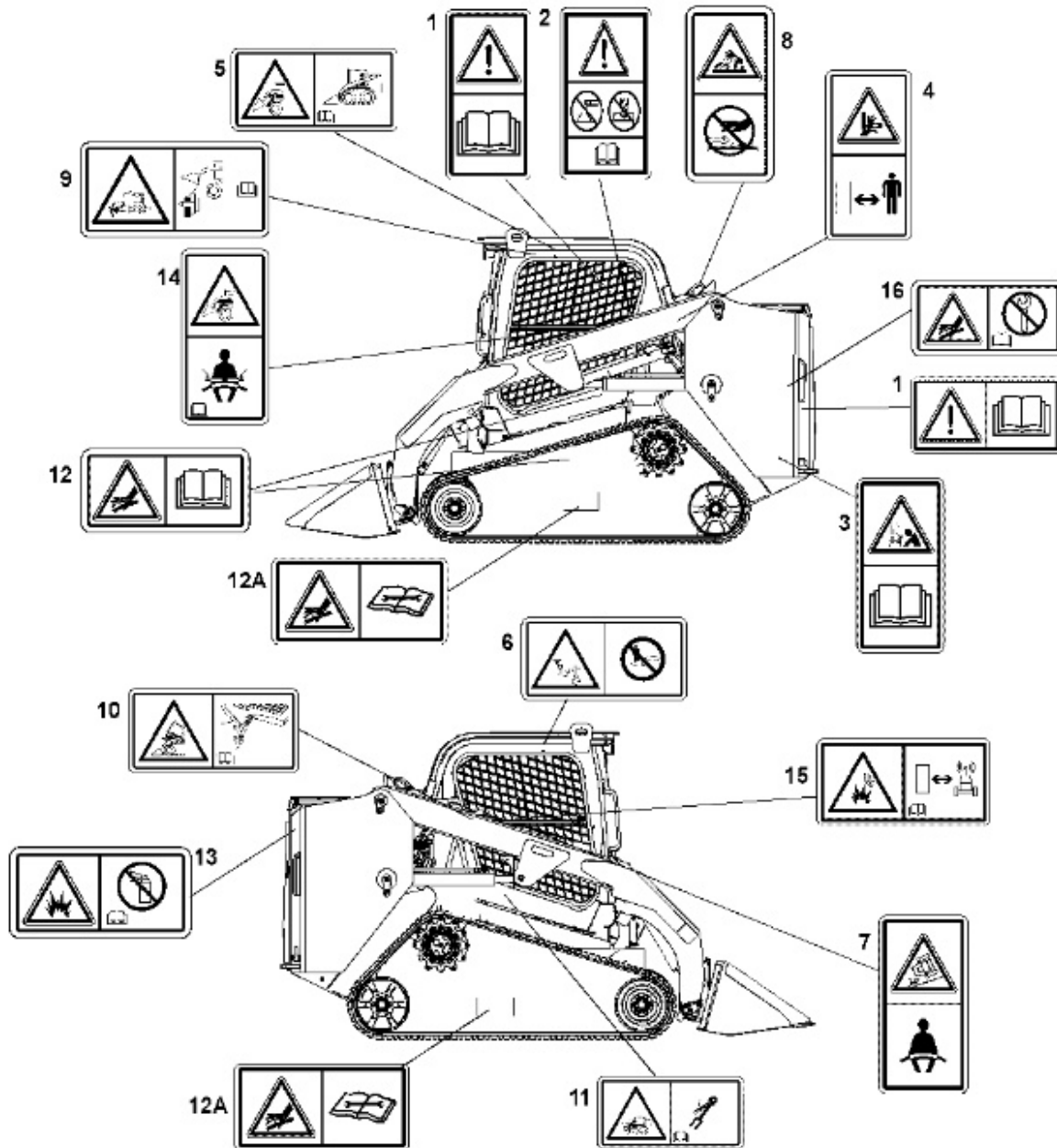

Illustration 1

g03209697

- (1) Do Not Operate.
- (2) Rollover Protective Structure/Falling Object Protective Structure
- (3) Jump Starting
- (4) Crushing Hazard
- (5) Stay Inside Operator Station
- (6) Never Permit Riders.
- (7) Seat Belt
- (8) Pressurized System
- (9) Work Tool Coupler
- (10) Cab Support
- (11) Brace for the Loader Lift Arms
- (12) Accumulator
- (12A) High Pressure Cylinder
- (13) Aerosol Starting Aid
- (14) Armrests

- (15) Product Link
- (16) High Pressure Fuel

### **Do Not Operate (1)**

This warning film is located inside the cab on the left hand rear ROPS post.



---

Illustration 2

g01379128



**Read and understand the instructions and warnings in the operation and maintenance manuals. Contact any Caterpillar dealer for replacement manuals. Proper care is your responsibility.**

**Be alert! Know work conditions. Note and avoid all hazards and obstructions. Keep by-standers away when operating.**

**Fasten seat belt and lower armrests.**

**Make certain all controls are in neutral position and start engine.**

**Disengage parking brake.**

**Machine controls are active.**

**Failure to follow the instructions or heed the warnings could result injury or death.**

---

### **Do Not Operate (1) (Engine)**

This message is also located on the engine.

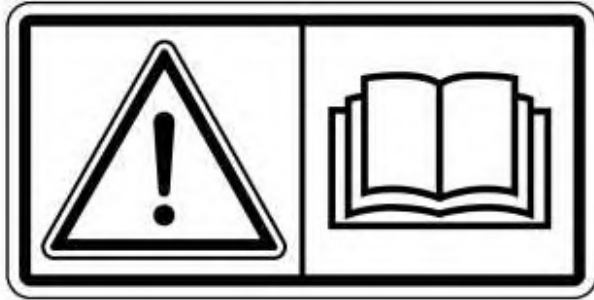

---

Illustration 3

g01370904

 **WARNING**

**Read and understand the instructions and warnings in the operation and maintenance manuals. Contact any Caterpillar dealer for replacement manuals. Proper care is your responsibility.**

**Be alert! Know work conditions. Note and avoid all hazards and obstructions. Keep by-standers away when operating.**

**Fasten seat belt and lower armrests.**

**Make certain all controls are in neutral position and start engine.**

**Disengage parking brake.**

**Machine controls are active.**

**Failure to follow the instructions or heed the warnings could result injury or death.**

---

### **Rollover Protective Structure/Falling Object Protective Structure (2)**

The no drill/no weld warning film is located inside the cab on the left hand rear ROPS post. The ROPS certification film is located inside the cab on the right hand rear ROPS post.

---



---

Illustration 4

g01212168



**Structural damage, an overturn, modification, alteration, or improper repair can impair this structure's protection capability thereby voiding this certification. Do not weld on or drill holes in the structure. Consult a Caterpillar dealer to determine this structure's limitations without voiding its certification.**

---

This machine has been certified to the standards that are listed on the certification plate. The maximum mass of the machine, which includes the operator and the attachments without a payload, should not exceed the mass on the certification film.

### **Jump Start (3)**

This warning message is located near the battery on the inside of the engine compartment.

---

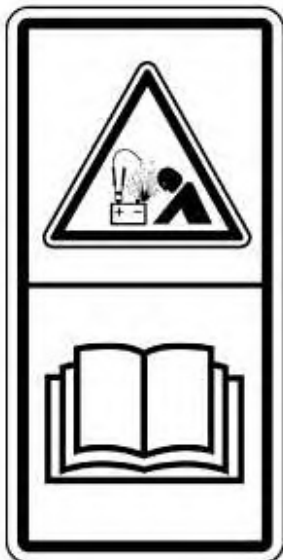

---

Illustration 5

g01409730

## **WARNING**

**Improper jumper cable connections can cause explosion resulting in personal injury. Batteries may be located in separate compartments, always connect positive (+) cable to positive (+) terminal of battery connected to starter solenoid and negative (-) cable from external source to engine block or frame.**

---

### **Crush Hazard (4)**

This warning is located on the loader arm linkage of the machines that are equipped with vertical lift.

---



Illustration 6

g01378775

## **WARNING**

**No clearance for person in this area during operation. Severe injury or death from crushing could occur. Stay away from the work tool while it is in operation.**

---

### **Stay Inside Operator Station (5)**

This warning message is located inside the cab on the upper left-hand switch console.

---

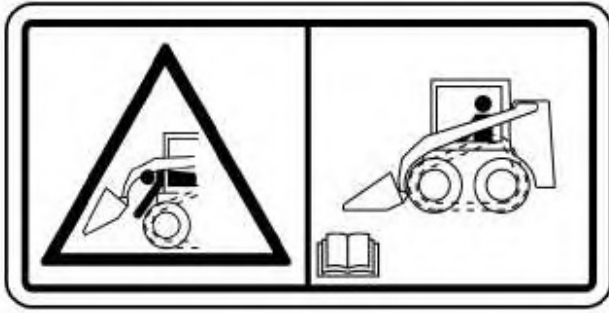

Illustration 7

g01427449

**! WARNING**

**Keep your body inside the operator station while operating the loader.**

**Never work with your arms, feet or legs beyond the operator station.**

**Failure to follow the instructions or heed the warnings will result in injury or death.**

**Never Permit Riders (6)**

This warning message is located inside the cab on the upper right-hand switch console.

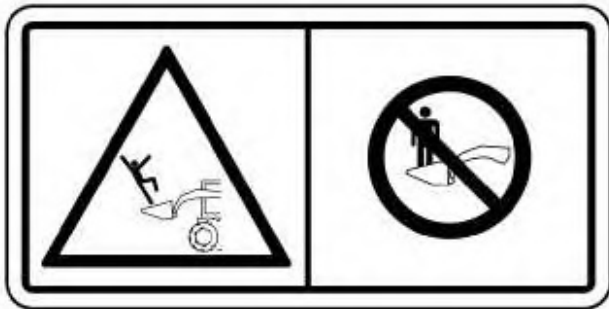

Illustration 8

g01427444

**! WARNING**

**Never permit riders.**

**Never use work tool for a work platform.**

Thank you so much for reading.  
Please click the “Buy Now!”  
button below to download the  
complete manual.



After you pay.

You can download the most  
perfect and complete manual in  
the world immediately.

Our support email:

[ebooklibonline@outlook.com](mailto:ebooklibonline@outlook.com)