

Product: EXCAVATOR

Model: 320 L EXCAVATOR 3XK

Configuration: 320, 320 L, 320 N AND 320 S EXCAVATORS 3XK00822-UP (MACHINE) POWERED BY 3116 ENGINE

Operation and Maintenance Manual 320, 320L, 320N & 320S EXCAVATORS

Media Number -SEBU6679-02

Publication Date -29/08/1994

Date Updated -14/07/2011

Foreword

SMCS - 7606

Literature Information

This manual should be stored in the operator's compartment in the literature holder or seat back literature storage area.

This manual contains safety, operation, transportation, lubrication and maintenance information.

Some photographs or illustrations in this publication show details or attachments that can be different from your machine. Guards and covers might have been removed for illustrative purposes.

Continuing improvement and advancement of product design might have caused changes to your machine which are not included in this publication. Read, study and keep this manual with the machine.

Whenever a question arises regarding your machine, or this publication, please consult your Caterpillar dealer for the latest available information.

Safety

The Safety Section lists basic safety precautions. In addition, this section identifies the text and locations of warning labels used on the machine.

Read and understand the basic precautions listed in the Safety Section before operating or performing lubrication, maintenance and repair on this machine.

Operation

The Operation Section is a reference for the new operator and a refresher for the experienced one. This section includes a discussion of gauges, switches, machine controls, implement controls, transportation and towing information.

Photographs and illustrations guide the operator through correct procedures of checking, starting, operating and stopping the machine.

Operating techniques outlined in this publication are basic. Skill and techniques develop as the operator gains knowledge of the machine and its capabilities.

Maintenance

The Maintenance Section is a guide to equipment care. The illustrated, step-by-step instructions are grouped by servicing intervals. Items without specific intervals are listed under When Required topics. Items in the Maintenance Intervals chart are referenced to detailed instructions that follow.

Maintenance Intervals

Use the service hour meter to determine servicing intervals. Calendar intervals shown (daily, weekly, monthly, etc.) can be used instead of service hour meter intervals if they provide more convenient servicing schedules and approximate the indicated service hour meter reading. Recommended service should always be performed at the interval that occurs first.

Under extremely severe, dusty or wet operating conditions, more frequent lubrication than is specified in the Maintenance Intervals chart might be necessary.

Perform service on items at multiples of the original requirement. For example, at Every 500 Service Hours or 3 Months, also service those items listed under Every 250 Service Hours or Monthly, Every 50 Service Hours or Weekly and Every 10 Service Hours or Daily.

Machine Description



This machine is equipped with a direct injection 3116 turbocharged engine and other specifically developed systems and components such as electronic power unit control system, work mode choice system, two-speed travel motor, etc. The machine is designed primarily for excavating and loading material.

Product: EXCAVATOR

Model: 320 L EXCAVATOR 3XK

Configuration: 320, 320 L, 320 N AND 320 S EXCAVATORS 3XK00822-UP (MACHINE) POWERED BY 3116 ENGINE

Operation and Maintenance Manual 320, 320L, 320N & 320S EXCAVATORS

Media Number -SEBU6679-02

Publication Date -29/08/1994

Date Updated -14/07/2011

Safety

SMCS - 7606

Warning Signs and Labels

There are several specific safety signs on your machine. Their exact location and description of the hazard are reviewed in this section. Please take the time to familiarize yourself with these safety signs.

Make sure that you can read all safety signs. Clean or replace these if you cannot read the words or see the pictures. When cleaning the labels use a cloth, water and soap. Do not use solvent, gasoline, etc.

You must replace a label if it is damaged, missing or cannot be read. If a label is on a part that is replaced, make sure a new label is installed on the replaced part. See your Caterpillar dealer for new labels.



Do not operate or work on this machine unless you have read and understand the instructions and warnings in the Operation and Maintenance Manual. Failure to follow the instructions or heed the warnings could result in injury or death. Contact any Caterpillar dealer for replacement manuals. Proper care is your responsibility.

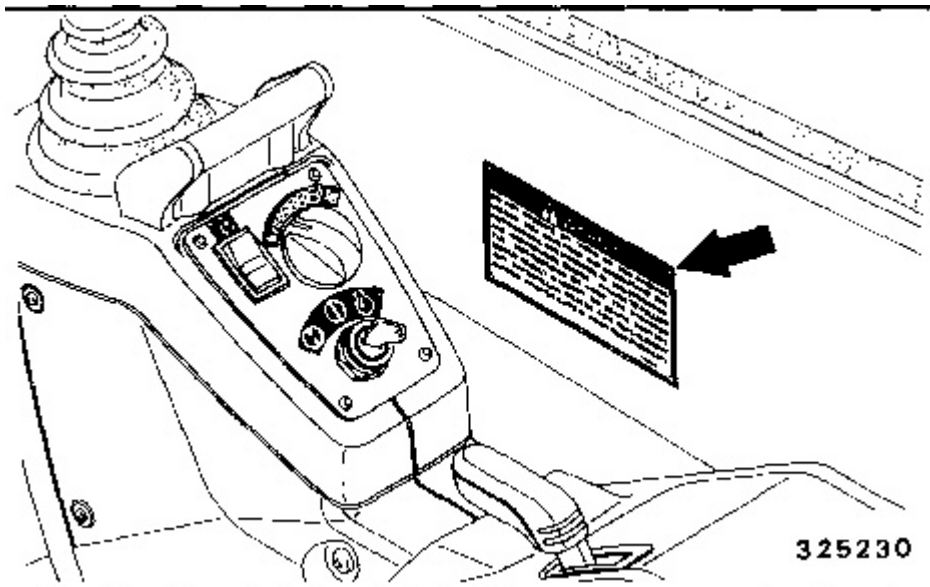

Located in the cab.

! WARNING

Know the maximum height and reach of your machine. Serious injury or death by electrocution can occur if machine or attachments are not kept a safe distance from electrical power lines. Keep distance at least 3 m (10 feet) plus additional 10 mm (0.4 inch) for each 1,000 volts over 50,000 volts.

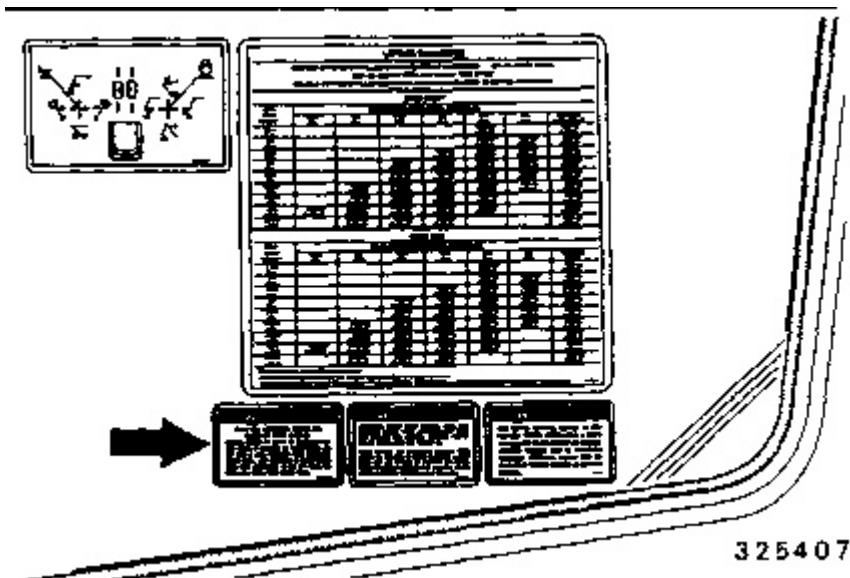

Located in the cab.

! WARNING

Improper jumper cable connections can cause an explosion resulting in personal injury. When using jumper cables always connect positive (+) cable to positive (+) terminal of battery connected to the starting motor solenoid and negative (-) cable from external source to the starting motor negative (-) terminal. (If not equipped with a starting motor negative terminal, connect to engine block.)



Located on the circuit breaker panel.

 **WARNING**

HYDRAULIC TANK

Relieve tank pressure with engine off by removing cap slowly to prevent burns from hot oil.

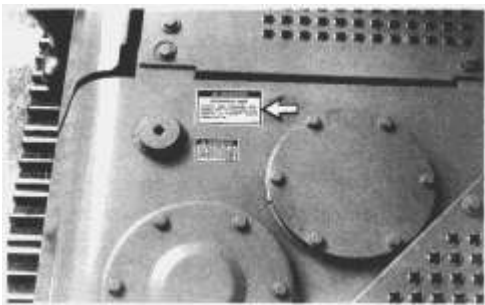

Located on the hydraulic tank.

 **WARNING**

Lift eyes or tank can fail when lifting tank containing fluids resulting in possible personal injury. Drain tank of all fluids before lifting.

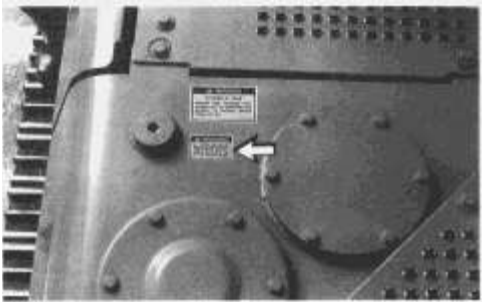

Located on the hydraulic tank and the fuel tank.

WARNING

HIGH PRESSURE CYLINDER

Do not remove or disassemble any hydraulic components or parts until pressure has been relieved or personal injury may occur.

To relieve pressure:

- 1. Stop the engine.**
- 2. With operator in seat and bucket on ground, engage neutralizing lever and actuate an implement control lever about ten times to dissipate pressure in hydraulic system.**

	CHARGING MEDIUM	NITROGEN
Precharge Pressure	18 kg/cm²	1765 kPa (255 psi)
Service Pressure	35 kg/cm²	3430 kPa (495 psi)
Minimum Bursting Pressure	105 kg/cm²	10295 kPa (1495 psi)

See your Caterpillar dealer for tools and detailed information.



Located on the accumulator.

WARNING

HIGH PRESSURE CYLINDER

Do not remove any parts until all pressure has been relieved to avoid possible personal injury. Relieve pressure by opening fill valve 1 turn maximum.

See the Maintenance Section of this manual for track adjustment procedure.

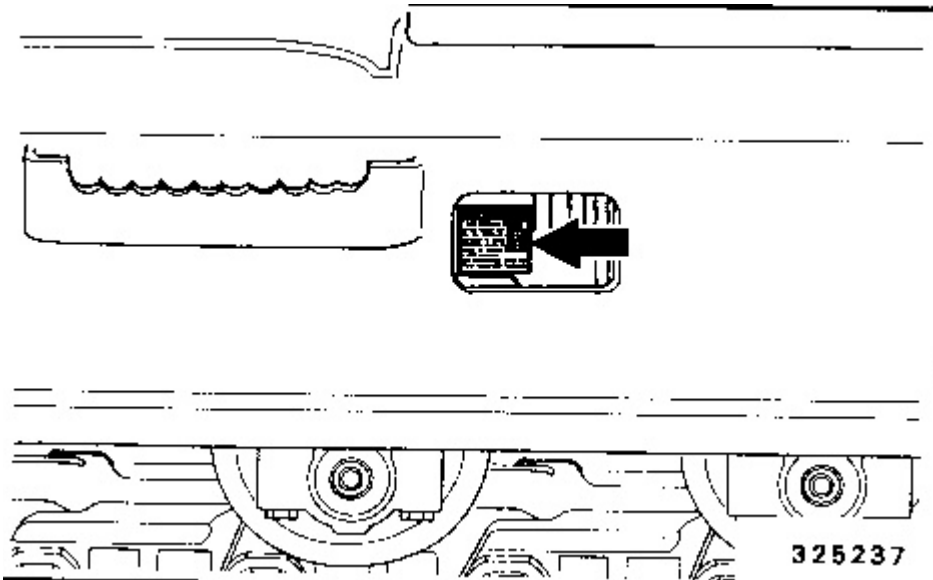

Located on both track frames.

WARNING

Automatic Engine Speed Control (AEC) will increase engine speed automatically when you operate the control lever(s) and/or travel pedals with AEC switch ON.

When loading and unloading machine from truck or working in close quarters always turn off AEC switch to prevent any possibility of sudden movement of machine, which could result in serious injury or death.

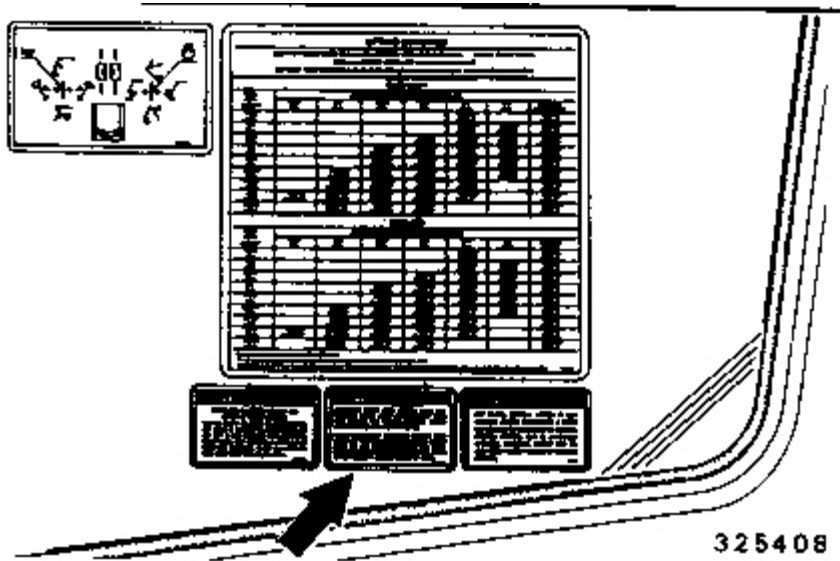

Located in the cab.

 **WARNING**

Put travel control switch in low position before descending a slope and loading or unloading on trailer. Machine control may be adversely affected. Personal injury can result from sudden change in machine control.

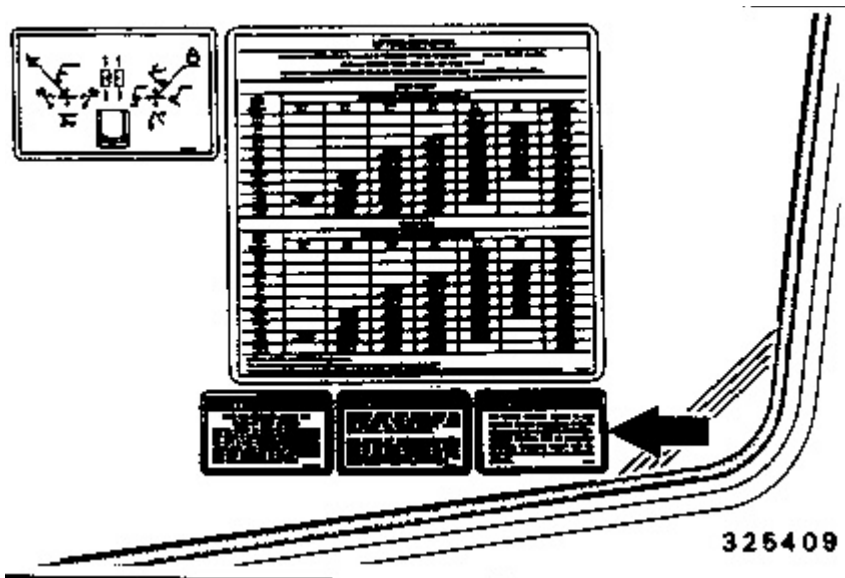

Located in the cab.

 **WARNING**

SWING LOCK CONTROL

Swing lock must be engaged before shipping machine. If lock is not engaged, upper structure can swing, resulting in possible personal injury.

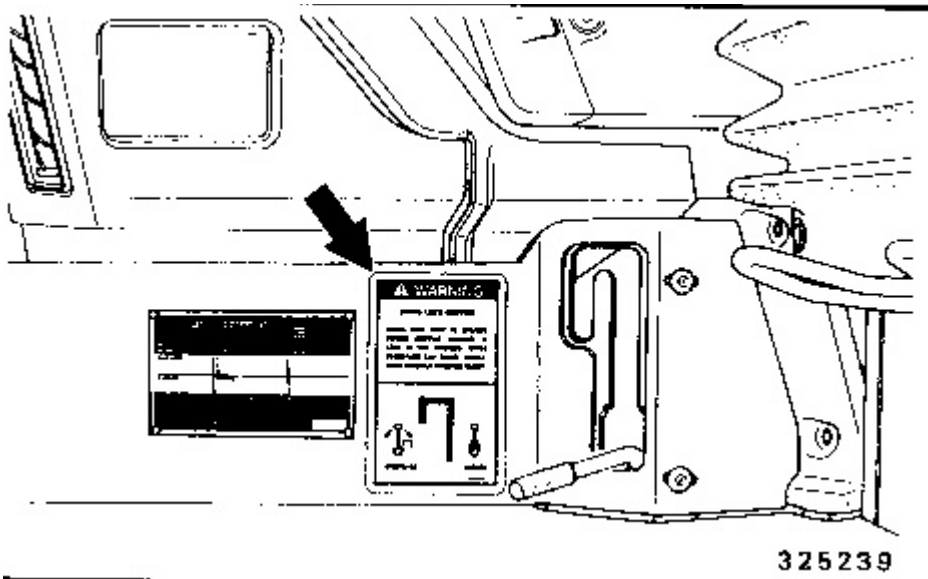

Located in the cab.

Visually check for proper swing lock pin engagement with the lower structure, especially before lifting or transporting the machine.

⚠ WARNING

Whenever a change is made to the machines control pattern also exchange the pattern card in the cab to match the new pattern. Follow the correct procedure in the Operation & Maintenance Manual.

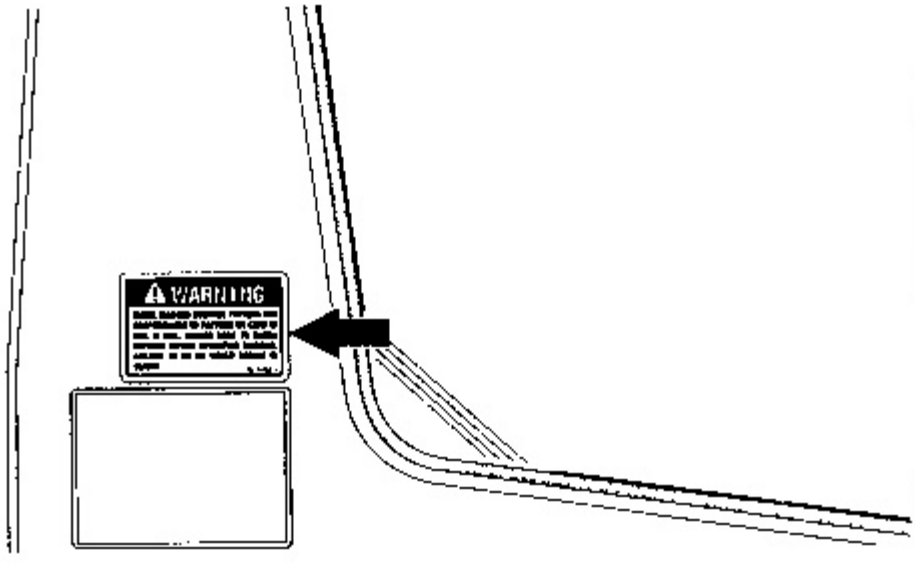

Located on the outside surface of the cab, if the machine is 2-way valve equipped.

! WARNING

Check machine control pattern for conformance to pattern on card in cab. If not, change card to match pattern before operating machine. Failure to do so could result in injury.

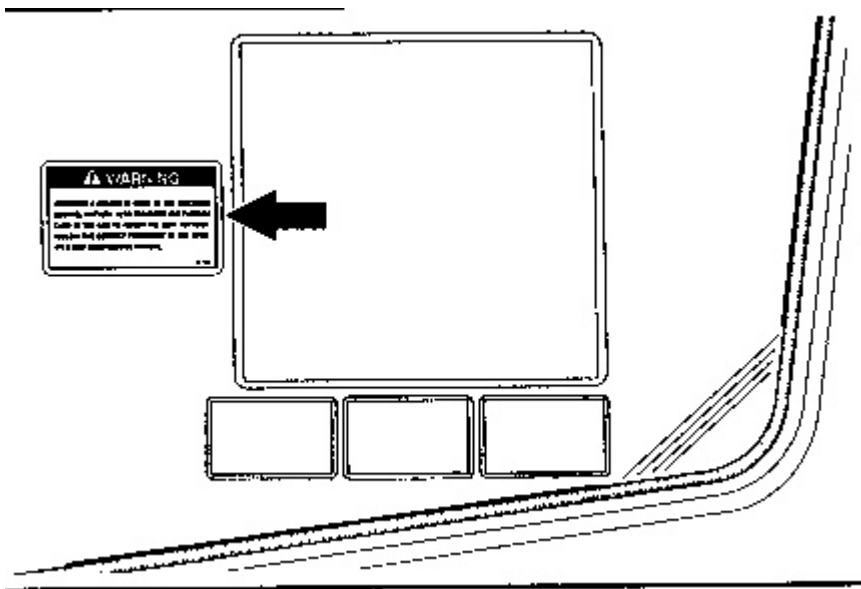

Located in the cab, if the machine is 2-way valve equipped.

General Hazard Information

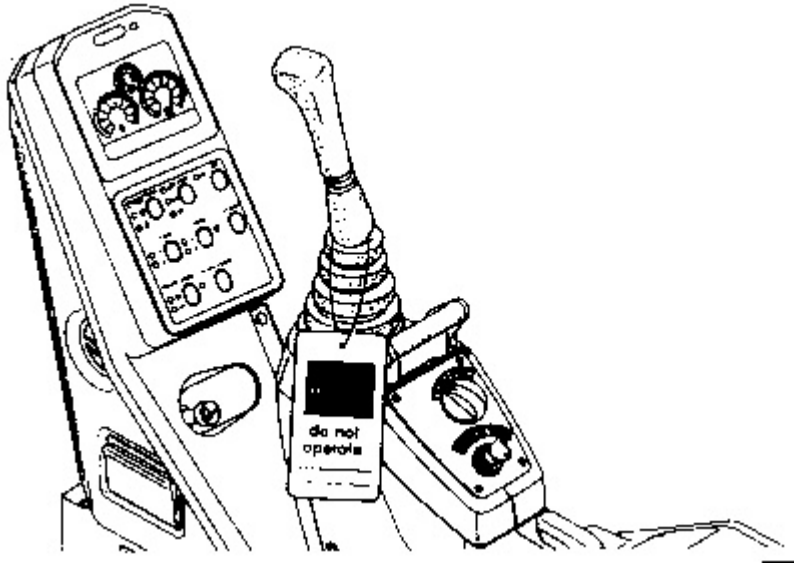

Attach a DO NOT OPERATE, SEHS7332, or similar warning tag to start switch or controls before servicing or repairing the machine. This tag is available from your Caterpillar dealer.

For machines equipped with automatic swing parking brake, disregard instructions for machines equipped with lock pin.

Know the width of your implements so proper clearance can be maintained when operating near fences, boundary obstacles, etc.

Wear a hard hat, protective glasses and other protective equipment as required by job conditions.

Do not wear loose clothing or jewelry that can catch on controls or other parts of the machine.

Make certain all protective guards and covers are secured in place on the machine.

Keep the machine, especially the deck, walkways and steps, free of foreign material, such as debris, oil, tools and other items which are not part of the machine.

Secure all loose items such as lunch boxes, tools and other items which are not part of the machine.

Know the appropriate work-site hand signals and who gives them. Accept signals from one person only.

Never put maintenance fluids into glass containers.

Inhaling air conditioner refrigerant gas through a lit cigarette or other smoking method or inhaling fumes released from a flame contacting air conditioner refrigerant gas can cause bodily harm or death. Do not smoke when servicing air conditioners or wherever refrigerant gas may be present.

Use all cleaning solutions with care.

Report all needed repairs.

Do not allow unauthorized personnel on the machine.

- * Park the machine on level ground.
- * Lower the implements to the ground.

- * Move the implement control levers to the HOLD position.
- * Move the hydraulic activation control lever to the LOCKED position.
- * Stop the engine.
- * Turn the engine start switch off and remove the key.
- * Turn the disconnect switch off and remove the key.

Falling Objects Guard

This is an attachment guard located above the operator's compartment and secured to the machine.

To avoid possible weakening of the Falling Objects Guard, consult a Caterpillar dealer before altering the Falling Objects Guard in any way. The protection offered by this Falling Objects Guard will be impaired if it has been subjected to structural damage. Structural damage can be caused by an overturn accident, by falling objects, etc.

Pressure Air

Pressure air can cause personal injury. When using pressure air for cleaning, wear a protective face shield, protective clothing and protective shoes.

The maximum air pressure must be below 205 kPa (30 psi) for cleaning purposes.

Fluid Penetration

Pressure can be maintained in the hydraulic circuit long after the engine has been stopped. The pressure can cause hydraulic fluid or items such as pipe plugs to shoot-out at high speed if pressure is not relieved correctly. Do not remove or disassemble any hydraulic components until pressure has been relieved or personal injury may occur.

To relieve pressure:

1. STOP the engine.
2. With operator in seat and bucket or attachment on ground, engage neutralizing lever and actuate an implement control lever about ten times to dissipate pressure in the hydraulic system.

Always use a board or cardboard when checking for a leak. Escaping fluid under pressure, even a pinhole leak, can penetrate body tissue, causing serious injury, and possible death. If fluid is injected into your skin, it must be treated by a doctor familiar with this type of injury immediately.

Track adjusting grease is under high pressure. Grease coming out of the relief valve under pressure can penetrate the body causing injury or death.

Do not watch the relief valve to see if grease is escaping. Watch the track or track adjustment cylinder to see if the track is being loosened. Loosen the relief valve one turn only.

Asbestos Information

This Caterpillar machine and replacement parts shipped from the factory are asbestos free. Caterpillar recommends the use of only genuine Caterpillar replacement parts. If any replacement parts containing asbestos are used, the following guidelines should be used in handling these parts and asbestos debris.

Caution should be used to avoid breathing dust that might be generated when handling components containing asbestos fibers. If this dust is inhaled, it can be hazardous to your health. Components that could be installed in Caterpillar products that might contain asbestos fibers are brake pads, brake band and lining assemblies, clutch plates and some gaskets. The asbestos used in these components is usually bound in a resin or sealed in some way. Normal handling is not hazardous as long as airborne dust which contains asbestos is not generated.

If dust which can contain asbestos is present, there are several common sense guidelines that should be followed.

- * Never use compressed air for cleaning.
- * Avoid brushing or grinding of asbestos containing materials.
- * For clean up, use wet methods or a vacuum equipped with a high efficiency particulate air (HEPA) filter.
- * Use exhaust ventilation on permanent machining jobs.
- * Wear an approved respirator if there is no other way to control the dust.
- * Comply with applicable rules and regulations for the work place (for example in the U.S.A., OSHA requirements as set forth in 29 CFR 1910.1001).
- * Follow environmental rules and regulations for disposal of asbestos.
- * Avoid areas where asbestos particles might be in the air.

Crushing or Cutting Prevention

Support equipment and implements properly when working beneath them. Do not depend on hydraulic cylinders to hold them up. An implement may fall if a control is moved, or if a hydraulic line breaks.

Never attempt adjustments while the machine is moving or the engine is running unless otherwise specified.

Where there are implement linkages, the clearance in the linkage area will increase or decrease with movement of the implement.

Stay clear of all rotating and moving parts.

Keep objects away from moving fan blades. They will throw or cut any object or tool that falls or is pushed into them.

Do not use a kinked or frayed wire rope cable. Wear gloves when handling a wire rope cable.

Retainer pins, when struck with force, can fly out and injure nearby persons. Make sure the area is clear of people when driving retainer pins.

Wear protective glasses when striking a retainer pin to avoid injury to your eyes.

Chips or other debris can fly off objects when struck. Make sure no one can be injured by flying debris before striking any object.

Do not attempt to lift the machine with the lift eyes on the cab or counterweight. Refer to the lifting instructions included in the Transportation Information portion of the Operation Section, or consult your Caterpillar dealer for lifting instructions.

Burn Prevention

Coolant

At operating temperature, the engine coolant is hot and under pressure. The radiator and all lines to heaters or the engine contain hot water or steam. Any contact can cause severe burns.

Steam can cause personal injury.

Check the coolant level only after the engine has been stopped and the fill cap is cool enough to remove with your bare hand.

Remove the cooling system fill cap slowly to relieve pressure.

Cooling system additive contains alkali that can cause personal injury. Avoid contact with the skin, eyes and mouth.

Allow cooling system components to cool before draining.

Oils

Hot oil and components can cause personal injury. Do not allow hot oil or components to contact the skin.

At operating temperature, the hydraulic tank is hot and can be under pressure.

To relieve the pressure from the hydraulic tank, remove the hydraulic pressure fill/vent plug at the top rear side of the tank.

Remove the hydraulic tank fill cap only after the engine has been stopped and the fill cap is cool enough to remove with your bare hand.

Remove the hydraulic tank fill cap slowly to relieve pressure.

Relieve all pressure in air, oil, fuel or cooling systems before any lines, fittings or related items are disconnected or removed.

Batteries

Batteries give off flammable fumes which can explode.

Do not smoke when observing the battery electrolyte levels.

Electrolyte is an acid and can cause personal injury if it contacts skin or eyes.

Always wear protective glasses when working with batteries.

Fire or Explosion Prevention

All fuels, most lubricants and some coolant mixtures are flammable.

Fuel leaked or spilled onto hot surfaces or electrical components can cause a fire.

Do not smoke while refueling or in a refueling area.

Do not smoke in areas where batteries are charged, or where flammable materials are stored.

Batteries can be located in separate compartments. When using jumper cables always connect positive (+) cable to positive (+) terminal of battery connected to the starting motor solenoid and negative (-) cable from external source to the starting motor negative (-) terminal. (If not equipped with a starting motor negative (-) terminal, connect to engine block.)

See the Operation Section of this manual for specific starting instructions.

Clean and tighten all electrical connections. Check daily for loose or frayed electrical wires. Have all loose or frayed electrical wires tightened, repaired or replaced before operating the machine.

Keep all fuels and lubricants stored in properly marked containers and away from all unauthorized persons.

Store all oily rags or other flammable material in a protective container, in a safe place.

Do not weld or flame cut on pipes or tubes that contain flammable fluids. Clean them thoroughly with nonflammable solvent before welding or flame cutting on them.

Remove all flammable materials such as fuel, oil and other debris before they accumulate on the machine.

Do not expose the machine to flames, burning brush, etc., if at all possible.

Shields, which protect hot exhaust components from oil or fuel spray in the event of a line, tube or seal failure, must be installed correctly.

Fire Extinguisher



Have a fire extinguisher available and know how to use it. Inspect and have it serviced as recommended on its instruction plate. The fire extinguisher maybe mounted behind the cab on top of the hood.

Ether

Read and follow the ether manufacturer's instructions when using ether to start a machine.

Ether is poisonous and flammable.

Breathing ether vapors or repeated contact of ether with skin can cause personal injury.

Use ether only in well ventilated areas.

Do not smoke while changing ether cylinders.

Use ether with care to avoid fires.

Do not store replacement ether cylinders in living areas or in the operator's compartment.

Do not store ether cylinders in direct sunlight or at temperatures above 39°C (102°F).

Discard cylinders in a safe place. Do not puncture or burn cylinders.

Keep ether cylinders out of the reach of unauthorized personnel.

Lines, Tubes and Hoses

Do not bend or strike high pressure lines. Do not install bent or damaged lines, tubes or hoses.

Repair any loose or damaged fuel and oil lines, tubes and hoses. Leaks can cause fires. Contact your Caterpillar dealer for repair or replacement.

Check lines, tubes and hoses carefully. Do not use your bare hand to check for leaks. Use a board or cardboard to check for leaks. See Fluid Penetration in the Safety Section for more details. Tighten all connections to the recommended torque. Replace if any of the following conditions are found.

- * End fittings damaged or leaking.
- * Outer covering chafed or cut and wire reinforcing exposed.
- * Outer covering ballooning locally.
- * Evidence of kinking or crushing of the flexible part of hose.
- * Armoring embedded in the outer cover.
- * End fittings displaced.

Make sure that all clamps, guards and heat shields are installed correctly to prevent vibration, rubbing against other parts, and excessive heat during operation.

Mounting and Dismounting

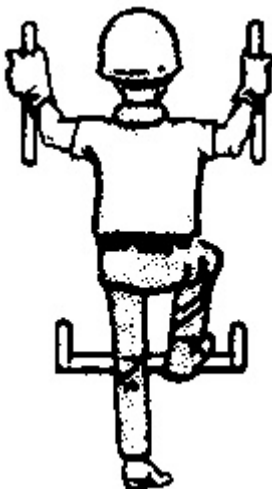

- * Mount and dismount the machine only where steps and/or handholds are provided.
- * Inspect, and when necessary, clean and have repairs made to steps and handholds before mounting and dismounting.
- * Face the machine when mounting and dismounting.

- * Maintain a three point contact (two feet and one hand or one foot and two hands contact) with the steps and handholds.
- * Never get on or off a moving machine.
- * Never jump off the machine.
- * Do not try to climb on or off the machine when carrying tools or supplies. Use a hand line to pull equipment up onto the platform.
- * Do not use any controls as handholds when entering or leaving the operator's station.

Alternate Exit

Machines equipped with cabs are equipped with alternate exits. For additional alternate exit information, refer to Rear Window in the Monitoring Systems and Cab Features section of this manual.

Before Starting the Engine

Start the engine only from the operator's station. Never short across the starting motor terminals or across the batteries, as this could bypass the engine neutral-start system as well as damage the electrical system.

Inspect the condition of the seat belt and mounting hardware. Replace any damaged or worn parts. Replace the seat belt, regardless of appearance, after three years of use. Do not use a seat belt extension on a retractable seat belt.

Adjust the seat so that full pedal travel can be obtained with the operator's back against the seat back.

Make sure the machine is equipped with a lighting system as required by conditions.

Make sure all lights are working properly.

Make sure no one is working on, underneath or close to the machine before starting the engine or beginning to move the machine. Make sure the area is free of personnel.

Engine Starting

Do not start the engine or move any of the controls if there is a DO NOT OPERATE or similar warning tag attached to the start switch or controls.

Move all hydraulic controls to the HOLD position before starting the engine.

Move the hydraulic activation control lever to the LOCKED position.

Diesel engine exhaust contains products of combustion which may be harmful to your health. Always start and operate the engine in a well ventilated area. If in an enclosed area, vent the exhaust to the outside.

Before Operating the Machine

Clear all personnel from the machine and the area.

Clear all obstacles from the path of the machine. Beware of hazards such as wires, ditches, etc.

Be sure all windows are clean. Secure the doors and windows in either the open or shut position.

Adjust the rear view mirrors (if equipped) for best vision, especially close to the machine.

Make sure the machine horn, the travel alarm (if equipped) and all other warning devices are working properly.

Before moving the machine, check the position of the undercarriage. The normal travel position is with the idler wheels to the front under the cab and the drive sprockets to the rear. When the undercarriage is in the opposite position, the directional controls must be operated in opposite directions.

Fasten the seat belt securely.

Warm up the engine and the hydraulic oil before operating the machine.

Machine Operation

Operate the machine only while seated and with the seat belt fastened.

Operate the controls only with the engine running to prevent uncontrolled movement of implements.

Check for proper operation of all controls and protective devices while moving slowly in an open area.

Watch boom clearances when moving the machine. Uneven ground can cause the boom to move from side to side or up and down.

Never travel a machine on a job site, in a congested area or around people, without a signal person to guide you. The signal person shall be responsible for determining and controlling speed and safety in moving.

Do not allow riders on the machine unless additional seat and seat belt are provided.

Report any needed repairs noted during operation.

Carry implements close to the ground, approximately 40 cm (15 in) above ground level.

Stay a safe distance from the edge of cliffs, overhangs and slide areas.

If the machine begins to sideslip on a grade, immediately dispose of the load and turn the machine downhill.

Be careful to avoid the condition which could lead to tipping when working on hills, banks or slopes, and when crossing ditches, ridges or other obstructions.

Work up and down slopes, rather than sideways, whenever possible.

Keep the machine under control and do not work it over its capacity.

Avoid changing the direction of travel on a slope, which could result in tipping or side slipping of the machine.

Bring the load close to the machine before traveling or swinging the load.

Lifting capacity decreases as the load is moved further from the machine.

Be sure hitch points and the towing device are adequate.

Connect trailing equipment to a drawbar or hitch only.

Never straddle a wire rope cable or similar device, nor allow others to do so.

No personnel should be between the machine and trailing equipment when maneuvering to connect them. Block the tongue or hitch of trailing equipment to align it with the drawbar or hitch.

Local or state codes, and/or job site operating directives may require a specific minimum distance from obstacles.

Do not attempt to engage the swing lock pin while the swing frame is rotating.

Check with the local utilities for the locations of buried pipes and cables before operating the machine.

Know the maximum height and reach of your machine.

Keep eye contact with the load at all times.

Always keep the Falling Objects Guard (if equipped) installed when operating the machine.

The Falling Objects Guard Structure will protect you in special applications like:

rock quarry, handling, lifting, demolition, clamshell.

The Front Windshield Guard in wire mesh will protect you when using hydraulic hammer.

Consult your Caterpillar dealer for the procurement and installation of these guards.

The clamshell can swing in all directions. Use hydraulic controls smoothly to avoid excessive clamshell swing. Failure to do so could cause the clamshell to swing into the cab or into a person in the work area, resulting in personal injury.

Lifting Objects

When this machine is used for lifting objects within the jurisdiction of the European Directive 89/392/EEC, it must be equipped with a Boom Lowering Control Device and an Overload Warning Device.

There may be some local government regulations regarding the use of excavators to lift heavy objects. Please observe those regulations where they apply.

Machine Parking

The hydraulic implement and machine controls are "live" for as long as the accumulator holds a charge, even if the engine is not running. This pressure charge should bleed off in a short time (approximately one minute).

Always move the hydraulic and directional lock lever to the LOCKED position before shutting off the engine or immediately after the engine quits running.

Park on a level surface. If necessary to park on a grade, block the machine.



Servicing position.

Place the attachments in the servicing position.

Move the hydraulic activation control lever to the LOCKED position.

Turn the engine start switch to the OFF position and remove the key.

Turn the battery disconnect switch key to OFF and remove when leaving the machine for an extended period of time, such as overnight. Also, remove the key when servicing the electrical system.

Sound and Vibration Information

Sound Level

The operator sound pressure level for this machine with a properly installed and maintained closed cab configuration is 75 dB (A).

Measurement is obtained on a static machine with the procedures and cab conditions as described in ISO 6394 or 86/662/EEC.

Vibration Level

Hands/Arms: The weighted root mean square acceleration to which the hands/arms are subjected, is less than the 2.5 m/s^2 requirement.

Whole Body: The weighted root mean square acceleration to which the whole body is subjected is less than 0.5 m/s^2 .

Measurements are obtained on a representative machine, using measuring procedures as set forth in the following standards: ISO 2631/1, ISO 5349, and SAE J1166.

Product: EXCAVATOR

Model: 320 L EXCAVATOR 3XK

Configuration: 320, 320 L, 320 N AND 320 S EXCAVATORS 3XK00822-UP (MACHINE) POWERED BY 3116 ENGINE

Operation and Maintenance Manual 320, 320L, 320N & 320S EXCAVATORS

Media Number -SEBU6679-02

Publication Date -29/08/1994

Date Updated -14/07/2011

Specifications and Model View

SMCS - 7606

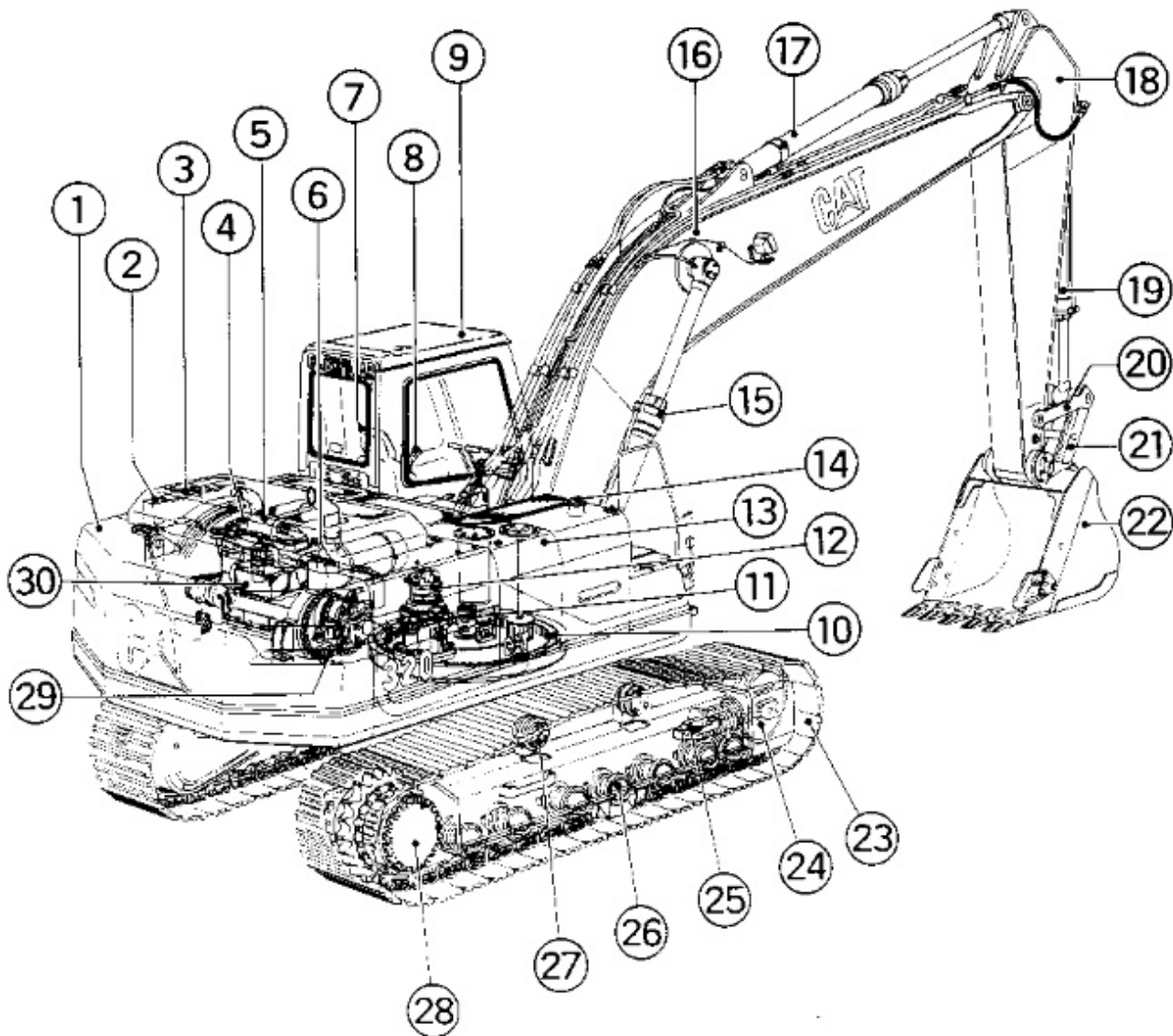

(1) Counterweight. (2) Engine Hood. (3) Radiator and Oil Cooler. (4) Engine. (5) Air Cleaner. (6) Control Valve. (7) Operator's Seat. (8) Implement Control Lever. (9) Cab. (10) Swing Bearing. (11) Swivel. (12) Swing Drive (with motor). (13) Hydraulic Tank. (14) Fuel Tank. (15) Boom Cylinder. (16) Boom. (17) Stick Cylinder. (18) Stick. (19) Bucket

Cylinder. (20) Link. (21) Power Link. (22) Bucket. (23) Track. (24) Idler. (25) Track Adjuster. (26) Track Roller. (27) Carrier Roller. (28) Final Drive (with motor). (29) Pump. (30) Battery.

Basic machine shipping specifications are listed below.

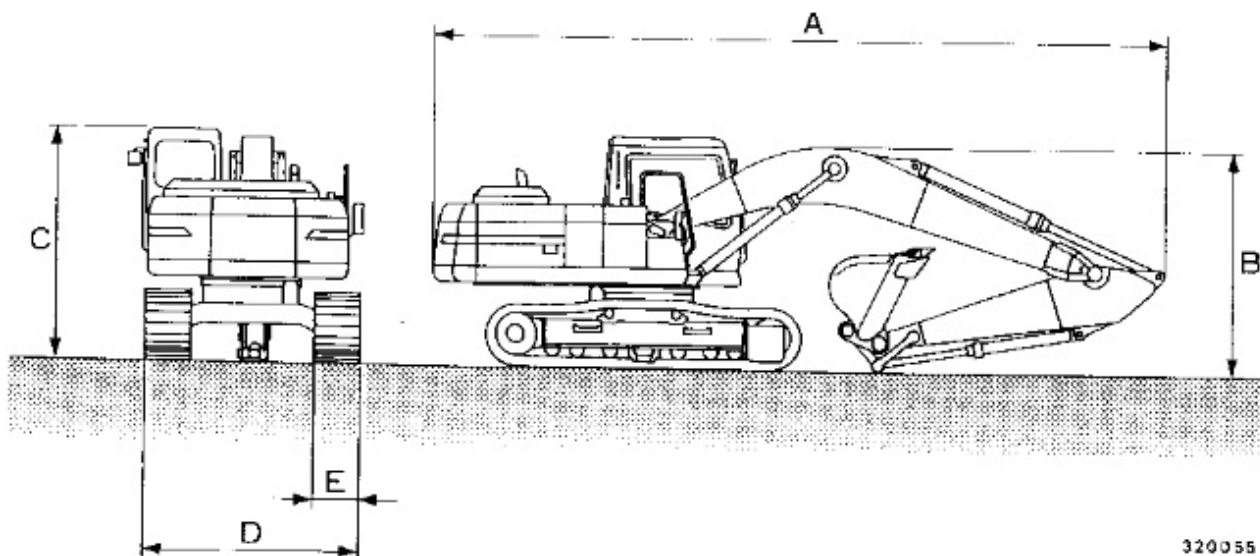

320055

320 Excavator¹ (4ZJ460-UP)	
Mass (approximate)	19880 kg (43830 lb)
Overall Length :A	9010 mm (29 ft 7 in)
Boom Height :B	3200 mm (10 ft 6 in)
Cab Height :C	3030 mm (9 ft 11 in)
Overall Width :D	2800 mm (9 ft 2 in)
Track Shoe Width :E	600 mm (2 ft)

¹ If equipped with 5.2 m (17 ft 0.7 in) boom, 2.4 m (7 ft 10 in) stick and 1.1 m³ bucket with full fuel.

320 L Excavator¹ (3XK822-UP)	
Mass (approximate)	21140 kg (46600 lb)
Overall Length :A	9010 mm (29 ft 7 in)
Boom Height :B	3200 mm (10 ft 6 in)
Cab Height :C	3030 mm (9 ft 11 in)
Overall Width :D	2980 mm (9 ft 9 in)
Track Shoe Width :E	600 mm (2 ft)

¹ If equipped with 5.2 m (17 ft 0.7 in) boom, 2.4 m (7 ft 10 in) stick and 1.2 m³ bucket with full fuel.

320 N Excavator¹ (9WG723-UP)	
Mass (approximate)	20140 kg (44400 lb)
Overall Length :A	9010 mm (29 ft 7 in)
Boom Height :B	3200 mm (10 ft 6 in)
Cab Height :C	3030 mm (9 ft 11 in)
Overall Width :D	2495 mm (8 ft 2 in)
Track Shoe Width :E	500 mm (1 ft 8 in)

¹ If equipped with 5.2 m (17 ft 0.7 in) boom, 2.4 m (7 ft 10 in) stick and 1.1 m³ bucket with full fuel.

320 S Excavator¹ (6KM1-UP)	
Mass (approximate)	22350 kg (49170 lb)
Overall Length :A	9000 mm (29 ft 6 in)
Boom Height :B	3130 mm (10 ft 3 in)
Cab Height :C	3118 mm (10 ft 3 in)
Overall Width :D	2497 mm (8 ft 2 in)
Track Shoe Width :E	550 mm (1 ft 10 in)

¹ If equipped with 5.2 m (17 ft 0.7 in) boom, 2.4 m (7 ft 10 in) stick and 1.1 m³ bucket with full fuel.

For information on specifications for configurations other than those included in the previous charts, consult your Caterpillar dealer.

Compatibility Chart For Boom/Stick/Bucket Combinations

This machine can be equipped with a large variety of front implement combinations to meet the needs of various applications.

Buckets are grouped into two different families "B" and "C" by capacity. As a general rule, to assure better machine stability and protect against structural machine damage, use a smaller capacity bucket when used with a longer stick and/or boom, and a larger one when used with a shorter stick and/or boom.

Each stick is designed to match a specific bucket family. It is not possible to attach buckets of a different family to a given stick.

The following charts represent various compatible combinations of the boom, stick and bucket. Select an optimum combination depending on type of work conditions and purposes.

Application	Bucket Capacity (SAE)	Bucket Width	Bucket Family	320, 320 N, & 320 S						
				R-Boom = 5.7 m (18 ft 8 in)			M-Boom = 5.2 m (17 ft 0.7 in)			
				Stick						
				R3.9B (12 ft 9 in)	R2.9B (9 ft 6 in)	R2.5B (8 ft 2 in)	R1.9C (6 ft 3 in)	M2.9B (9 ft 6 in)	M2.4C (7 ft 10 in)	M1.9C (6 ft 3 in)
X	0.9 m ³	1200 mm (3 ft 11 in)	B			○				
	1.0 m ³	1305 mm (4 ft 3 in)				○		⊕		
	1.1 m ³	1370 mm (4 ft 6 in)	C				⊕		⊕	
	1.2 m ³	1470 mm (4 ft 10 in)								⊕
T	0.7 m ³	900 mm (2 ft 11 in)	B	⊕						
	0.8 m ³	1000 mm (3 ft 3 in)			○					
	0.9 m ³	1000 mm (3 ft 3 in)				⊕		○		
	1.0 m ³	1075 mm (3 ft 6 in)	C						○	
	1.1 m ³	1075 mm (3 ft 6 in)					○		○	
EX	0.8 m ³	1100 mm (3 ft 3 in)	B		○	○				
	1.0 m ³	1200 mm (3 ft 11 in)	C				○		○	
EMX	1.2 m ³	1378 mm (4 ft 6 in)	C							○

⊕ = Preferred

○ = Permissible

Notes:

1. Description of Abbreviations

A. R-Boom = REACH Boom

M-Boom = MASS Boom

B. R2.9B STICK, as a typical example, is a designation of a 2.9m stick that Caterpillar recommends to be used with a reach boom and 'B' family bucket.

C. X = EXCAVATION

T = TRENCHING

EX = EXTREME SERVICE EXCAVATION

EMX = EXTREME SERVICE MASS EXCAVATION

2. The BUCKET WIDTH indicates the maximum width including both end tips.

For more details, contact your Caterpillar dealer.

Application	Bucket Capacity (SAE)	Bucket Width	Bucket Family	320 L						
				R-Boom = 5.7 m (18 ft 8 in)			M-Boom = 5.2 m (17 ft 0.7 in)			
				Stick						
				R3.9B (12 ft 9 in)	R2.9B (9 ft 6 in)	R2.5B (8 ft 2 in)	R1.9C (6 ft 3 in)	M2.9B (9 ft 6 in)	M2.4C (7 ft 10 in)	M1.9C (6 ft 3 in)
X	0.9 m ³	1200 mm (3 ft 11 in)	B		○					
	1.0 m ³	1305 mm (4 ft 3 in)			○	⊖		⊖		
	1.2 m ³	1470 mm (4 ft 10 in)	C				⊖		⊖	
MX	1.3 m ³	1440 mm (4 ft 9 in)	C						○	⊖
T	0.7 m ³	900 mm (2 ft 11 in)	B							
	0.8 m ³	1000 mm (3 ft 3 in)		○						
	0.9 m ³	1000 mm (3 ft 3 in)			⊖	○		○		
	1.0 m ³	1075 mm (3 ft 6 in)	C						○	
	1.1 m ³	1075 mm (3 ft 6 in)					○		○	
EX	0.8 m ³	1100 mm (3 ft 3 in)	B		○	○				
	1.0 m ³	1200 mm (3 ft 11 in)	C							
EMX	1.2 m ³	1378 mm (4 ft 6 in)	C				○		○	○

○ = Preferred

○ = Permissible

Notes:

1. Description of Abbreviations

A. R-Boom = REACH Boom

M-Boom = MASS Boom

B. R2.9B STICK, as a typical example, is a designation of a 2.9m stick that Caterpillar recommends to be used with a reach boom and "B" family bucket.

C. X = EXCAVATION

MX = MASS EXCAVATION

T = TRENCHING

EX = EXTREME SERVICE EXCAVATION

EMX = EXTREME SERVICE MASS EXCAVATION

2. The BUCKET WIDTH indicates the maximum width including both end tips.

For more details, contact your Caterpillar dealer.

Thank you so much for reading.
Please click the “Buy Now!”
button below to download the
complete manual.



After you pay.

You can download the most
perfect and complete manual in
the world immediately.

Our support email:

ebooklibonline@outlook.com