

Product: EXCAVATOR

Model: 320D FM EXCAVATOR BZF

Configuration: 320D Forest Machines BZF00001-UP (MACHINE) POWERED BY C6.4 Engine

## **Operation and Maintenance Manual 320D Forest Machines**

Media Number -SEBU8215-10

Publication Date -01/04/2013

Date Updated -14/09/2017

s00037320

## **Foreword**

### **Literature Information**

This manual should be stored in the operator's compartment in the literature holder or seat back literature storage area.

This manual contains safety information, operation instructions, transportation information, lubrication information and maintenance information.

Some photographs or illustrations in this publication show details or attachments that can be different from your machine. Guards and covers might have been removed for illustrative purposes.

Continuing improvement and advancement of product design might have caused changes to your machine which are not included in this publication. Read, study and keep this manual with the machine.

Whenever a question arises regarding your machine, or this publication, please consult your Cat dealer for the latest available information.

## **Safety**

The safety section lists basic safety precautions. In addition, this section identifies the text and locations of warning signs and labels used on the machine.

Read and understand the basic precautions listed in the safety section before operating or performing lubrication, maintenance and repair on this machine.

## **Operation**

The operation section is a reference for the new operator and a refresher for the experienced operator. This section includes a discussion of gauges, switches, machine controls, attachment controls, transportation and towing information.

Photographs and illustrations guide the operator through correct procedures of checking, starting, operating and stopping the machine.

Operating techniques outlined in this publication are basic. Skill and techniques develop as the operator gains knowledge of the machine and its capabilities.

## Maintenance

The maintenance section is a guide to equipment care. The Maintenance Interval Schedule (MIS) lists the items to be maintained at a specific service interval. Items without specific intervals are listed under the "When Required" service interval. The Maintenance Interval Schedule lists the page number for the step-by-step instructions required to accomplish the scheduled maintenance. Use the Maintenance Interval Schedule as an index or "one safe source" for all maintenance procedures.

### Maintenance Intervals

Use the service hour meter to determine servicing intervals. Calendar intervals shown (daily, weekly, monthly, etc.) can be used instead of service hour meter intervals if they provide more convenient servicing schedules and approximate the indicated service hour meter reading. Recommended service should always be performed at the interval that occurs first.

Under extremely severe, dusty or wet operating conditions, more frequent lubrication than is specified in the maintenance intervals chart might be necessary.

Perform service on items at multiples of the original requirement. For example, at every 500 service hours or 3 months, also service those items listed under every 250 service hours or monthly and every 10 service hours or daily.

## California Proposition 65 Warning

Diesel engine exhaust and some of its constituents are known to the State of California to cause cancer, birth defects, and other reproductive harm.

Battery posts, terminals and related accessories contain lead and lead compounds. **Wash hands after handling.**

## Certified Engine Maintenance

Proper maintenance and repair is essential to keep the engine and machine systems operating correctly. As the heavy duty off-road diesel engine owner, you are responsible for the performance of the required maintenance listed in the Owner Manual, Operation and Maintenance Manual, and Service Manual.

It is prohibited for any person engaged in the business of repairing, servicing, selling, leasing, or trading engines or machines to remove, alter, or render inoperative any emission related device or element of design installed on or in an engine or machine that is in compliance with the regulations (40 CFR Part 89). Certain elements of the machine and engine such as the exhaust system, fuel system, electrical system, intake air system and cooling system may be emission related and should not be altered unless approved by Caterpillar.

## Machine Capacity

Additional attachments or modifications may exceed machine design capacity which can adversely affect performance characteristics. Included would be stability and system certifications such as brakes, steering, and rollover protective structures (ROPS). Contact your Cat dealer for further information.

## Cat Product Identification Number

Effective First Quarter 2001 the Cat Product Identification Number (PIN) has changed from 8 to 17 characters. In an effort to provide uniform equipment identification, Caterpillar and other construction equipment manufacturers are moving to comply with the latest version of the product identification numbering standard. Non-road machine PINs are defined by ISO 10261. The new PIN format will apply to all Cat machines and generator sets. The PIN plates and frame marking will display the 17 character PIN. The new format will look like the following:



---

Illustration 1

g00751314

Where:

1. Caterpillar's World Manufacturing Code (characters 1-3)
2. Machine Descriptor (characters 4-8)
3. Check Character (character 9)
4. Machine Indicator Section (MIS) or Product Sequence Number (characters 10-17). These were previously referred to as the Serial Number.

Machines and generator sets produced before First Quarter 2001 will maintain their 8 character PIN format.

Components such as engines, transmissions, axles, etc. and work tools will continue to use an 8 character Serial Number (S/N).

---

Product: EXCAVATOR

Model: 320D FM EXCAVATOR BZF

Configuration: 320D Forest Machines BZF00001-UP (MACHINE) POWERED BY C6.4 Engine

## **Operation and Maintenance Manual**

### **320D Forest Machines**

Media Number -SEBU8215-10

Publication Date -01/04/2013

Date Updated -14/09/2017

i03978393

## **Safety Messages**

SMCS - 7000; 7405

There are a number of specific safety messages on this machine. The exact location of the messages and the description of the hazards are reviewed in this section. Become familiar with all safety messages.

Make sure that all of the safety messages are legible. Clean the safety messages or replace the safety messages if you cannot read the words. Replace the illustrations if the illustrations are not visible. When you clean the safety messages, use a cloth, water, and soap. Do not use solvent, gasoline, or other harsh chemicals to clean the safety messages. Solvents, gasoline, or harsh chemicals could loosen the adhesive that secures the safety message. Loose adhesive will allow the safety message to fall.

Replace any safety message that is damaged, or missing. If a safety message is attached to a part that is replaced, install a safety message on the replacement part. Any Caterpillar dealer can provide new safety messages.

The following numbered illustrations display the locations of warning labels on the machine.

---

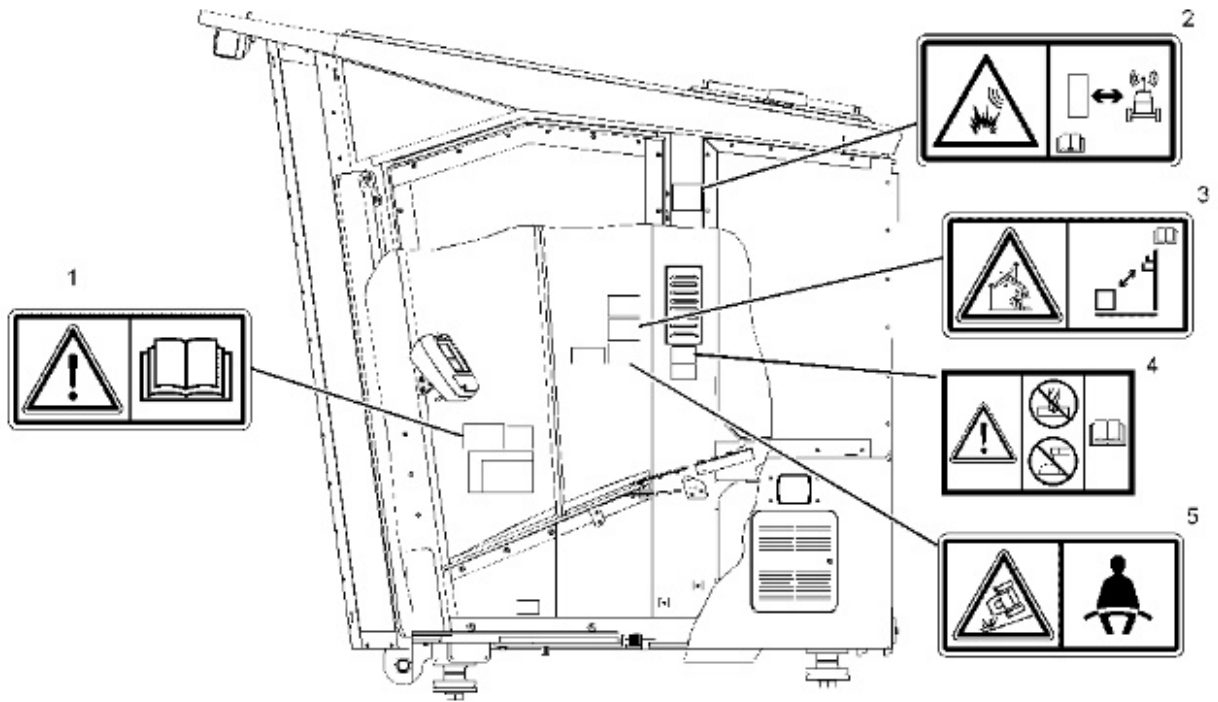

Illustration 1

g01438533

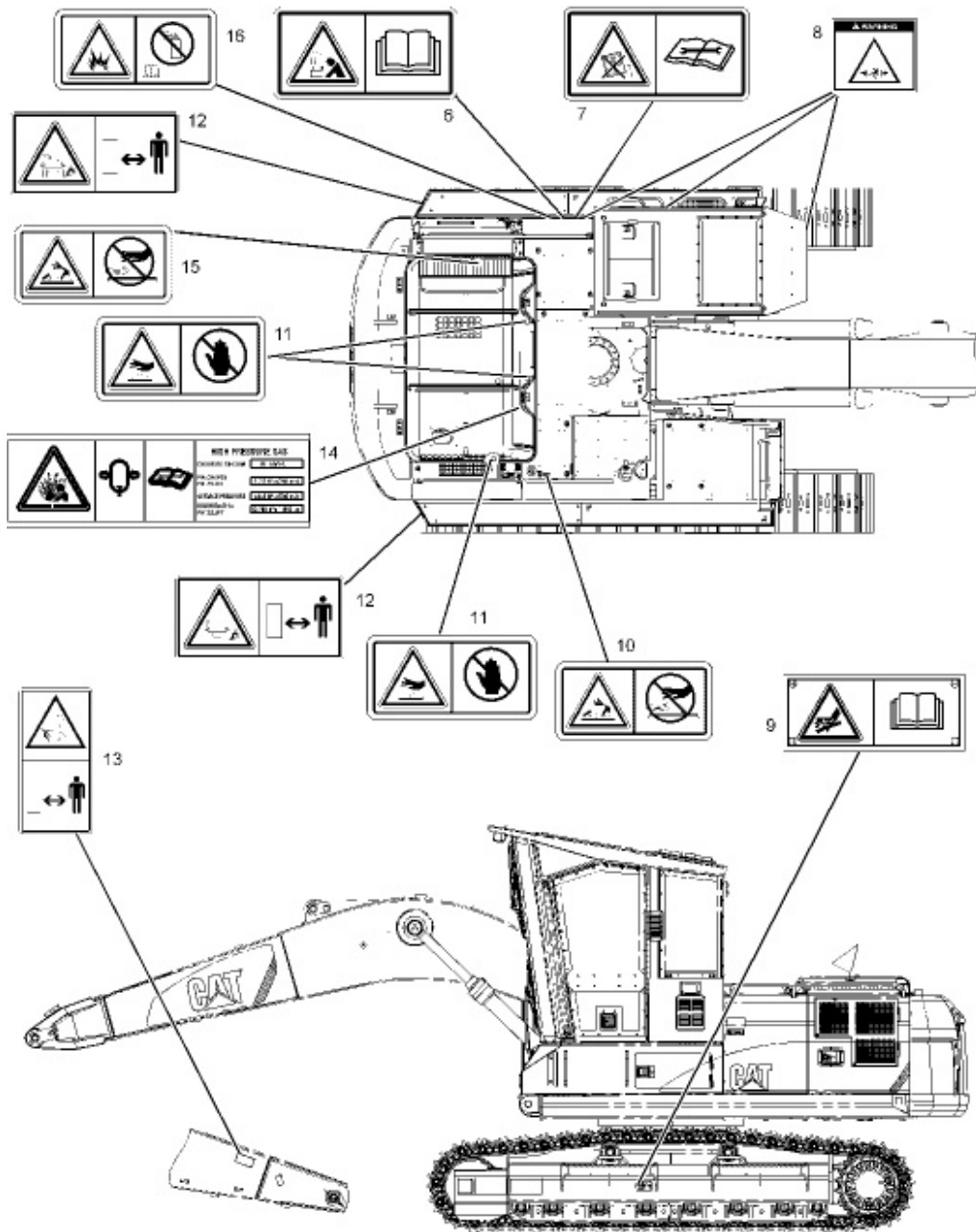
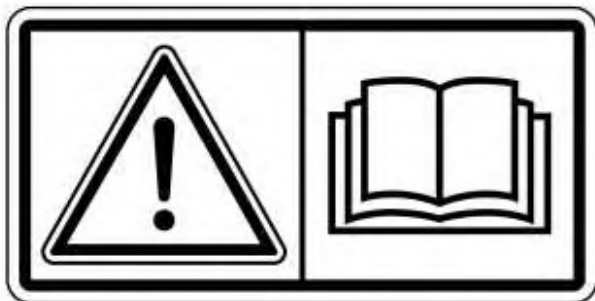

Illustration 2

g02164499

**Do Not Operate (1)**



This safety message is located in the cab on the right side window.



**Do not operate or work on this machine unless you have read and understand the instructions and warnings in the Operation and Maintenance Manuals. Failure to follow the instructions or heed the warnings could result in injury or death. Contact any Caterpillar dealer for replacement manuals. Proper care is your responsibility.**

---

### Product Link (2)

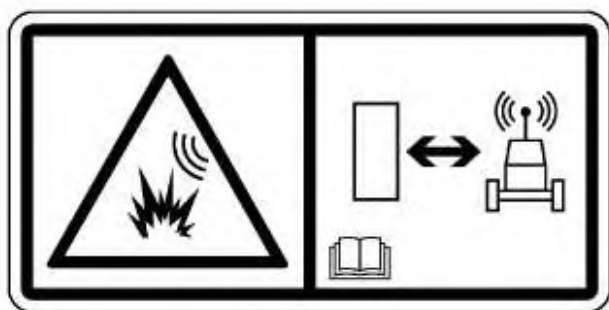

This safety message is located on the front right side door post.



**This machine is equipped with a Caterpillar Product Link communication device. When electric/electronic detonators are used, this communication device should be deactivated within 12 m (40 ft) of a blast site, or within the distance mandated under applicable legal requirements. Failure to do so could cause interference with blasting operations and result in serious injury or death.**

---

### Electrical Power Lines (3)

---



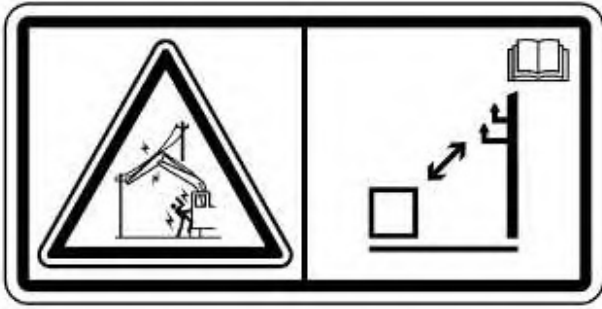

Illustration 5

g01374045

This safety message is located in the cab on the right side window.



**Electrocution Hazard! Keep the machine and attachments a safe distance from electrical power. Stay clear 3 m (10 ft) plus twice the line insulator length. Read and understand the instructions and warnings in the Operation and Maintenance Manual. Failure to follow the instructions and warnings will cause serious injury or death**

Refer to Operation and Maintenance Manual, "Specifications" for further information.

#### ROPS/FOPS Structure (4)

This safety message is located on the left side of the falling object guard structure.

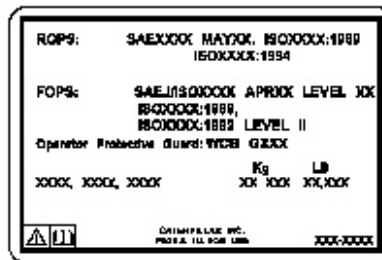
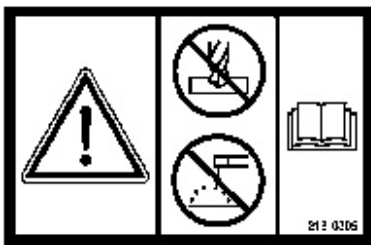

Illustration 6

g00939192

## **WARNING**

**Structural damage, an overturn, modification, alteration, or improper repair can impair this structure's protection capability thereby voiding this certification. Do not weld on or drill holes in the structure. This will void the certification. Consult a Caterpillar dealer to determine this structure's limitations without voiding its certification.**

---

This machine has been certified to the standards that are listed on the certification film. The maximum mass of the machine, which includes the operator and the attachments without a payload, should not exceed the mass on the certification film.

### **Seat Belt (5)**



Illustration 7

g01370908

This safety message is located in the cab on the right side window.

## **WARNING**

**A seat belt should be worn at all times during machine operation to prevent serious injury or death in the event of an accident or machine overturn. Failure to wear a seat belt during machine operation may result in serious injury or death.**

---

### **Jump Start Cables (6)**

---

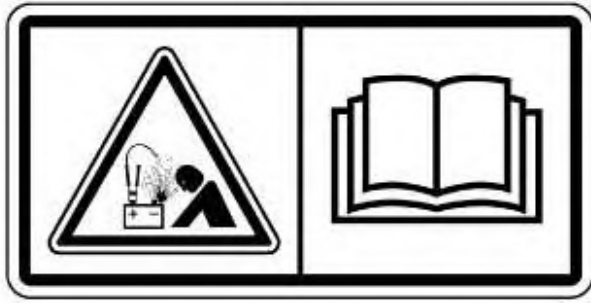

Illustration 8

g01370909

This safety message is located inside the left front compartment.



**Explosion Hazard! Improper jumper cable connections can cause an explosion resulting in serious injury or death. Batteries may be located in separate compartments. Refer to the Operation and Maintenance Manual for the correct jump starting procedure.**

### Tilting the Cab (7)

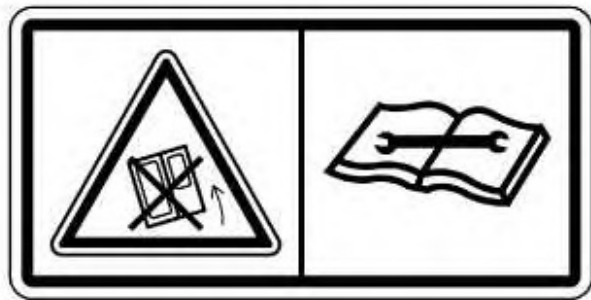

Illustration 9

g01384815

This safety message is positioned on the front access door on the left side of the machine.



**Do not tilt the cab when occupied. Before tilting the cab remove all loose articles from the cab, secure all windows and emergency exits, and then**

close the cab and cab riser doors. Failure to do so can result in personal injury or damage to the machine.

---

### Crush Points (8)

---



Illustration 10

g00104210

This safety message is positioned on the access door riser and on the front access door on the left side of the machine. This warning is also located on the front of the machine near the boom foot.



**Stand away from the cab when the cab is being tilted for transportation or repair. There is no clearance for a person in this area. Severe injury or death from crushing could occur.**

---

### High Pressure Cylinder (9)

---

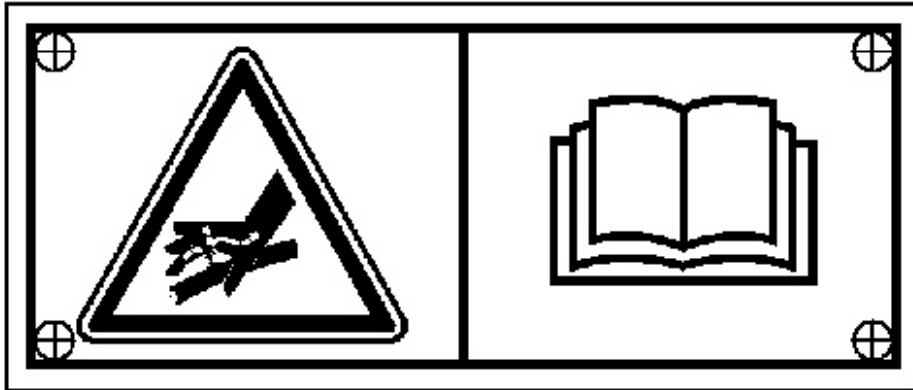

Illustration 11

g01076729

This safety message is located on the track adjuster.



**High Pressure Cylinder. Do not remove any parts from the cylinder until all of the pressure has been relieved. This will prevent possible personal injury or death.**

Refer to Operation and Maintenance Manual , "Track Adjustment - Adjust" for the proper service procedure.

### Relieve Hydraulic Tank Pressure (10)



Illustration 12

g01371640

This safety message is located on top of the hydraulic tank.

 **WARNING**

**HYDRAULIC TANK**

**RELIEVE TANK PRESSURE WITH ENGINE OFF BY REMOVING CAP SLOWLY TO PREVENT BURNS FROM HOT OIL.**

---

**Hot Surface (11)**

---



Illustration 13

g01372256

This message is located on the radiator and on other hot surfaces.

 **WARNING**

**Hot parts or hot components can cause burns or personal injury. Do not allow hot parts or components to contact your skin. Use protective clothing or protective equipment to protect your skin.**

---

**Crushing Hazard (12)**

---

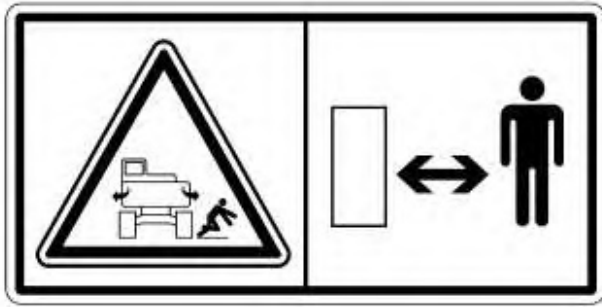

Illustration 14

g01374060

This safety message is located on both sides of the back end of the machine.



**Machine swings. Stay back. Crushing hazard could cause serious injury or death.**

### Crushing Hazard (13)

This safety message is located on both sides of the stick.

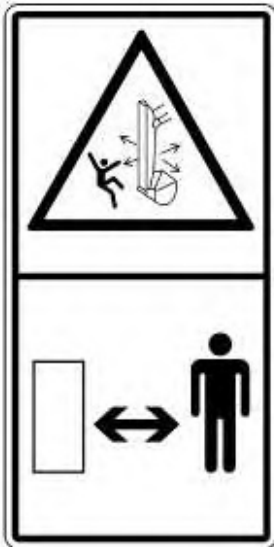

Illustration 15

g01385579



**A crushing hazard exists when the stick and boom are in motion and when the machine is being used in object handling applications. Failure to stay clear of the stick and boom when the machine is in operation can result in personal injury or death. Stay clear of the stick and boom when the machine is in operation.**

---

## High Pressure Gas (14)

---

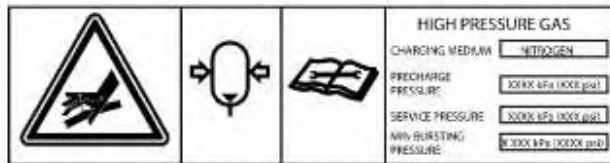

Illustration 16

g01374065

This safety message is located on the accumulator in the right back compartment.



**This system contains high pressure gas. Failure to follow the instructions and warnings could cause an explosion, resulting in possible injury or death.**

**Do not expose to fire. Do not weld. Do not drill. Relieve pressure before discharging.**

**See Operation and Maintenance Manual for charging and discharging. See your Caterpillar Dealer for tools and detailed information.**

---

Refer to Operation and Maintenance Manual, "Equipment Lowering with Engine Stopped" for further information.

## Pressurized System (15)

---





Illustration 17

g01371640

This safety message is located on top of the radiator, next to the filler cap.



**Pressurized system! Hot coolant can cause serious burns, injury or death. To open the cooling system filler cap, stop the engine and wait until the cooling system components are cool. Loosen the cooling system pressure cap slowly in order to relieve the pressure. Read and understand the Operation and Maintenance Manual before performing any cooling system maintenance.**

### Aerosol Starting Aid (16)



Illustration 18

g01372254

This safety message is located inside the left front compartment on the engine air filter.



Thank you so much for reading.  
Please click the “Buy Now!”  
button below to download the  
complete manual.



After you pay.

You can download the most  
perfect and complete manual in  
the world immediately.

Our support email:

[ebooklibonline@outlook.com](mailto:ebooklibonline@outlook.com)