

Product: EXCAVATOR

Model: 320D2 EXCAVATOR XCC

Configuration: 320D2 L Excavator XCC00001-UP (MACHINE) POWERED BY C7.1 Engine

## Operation and Maintenance Manual 320D2 Excavator

Media Number -SEBU9247-08

Publication Date -01/09/2015

Date Updated -24/08/2018

s03548206

## Foreword

SMCS - 7008; 7600-ZM

## California Proposition 65 Warning

**Diesel engine exhaust and some of its constituents are known to the State of California to cause cancer, birth defects, and other reproductive harm.**



**WARNING** - This product can expose you to chemicals including ethylene glycol, which is known to the State of California to cause birth defects or other reproductive harm. For more information go to:

[www.P65Warnings.ca.gov](http://www.P65Warnings.ca.gov)

**Do not ingest this chemical. Wash hands after handling to avoid incidental ingestion.**



**WARNING** - This product can expose you to chemicals including lead and lead compounds, which are known to the State of California to cause cancer, birth defects, or other reproductive harm. For more information go to:

[www.P65Warnings.ca.gov](http://www.P65Warnings.ca.gov)

**Wash hands after handling components that may contain lead.**

## Literature Information

This manual should be stored in the operator's compartment in the literature holder or seat back literature storage area.

This manual contains safety information, operation instructions, transportation information, lubrication information, and maintenance information.

Some photographs or illustrations in this publication show details or attachments that can be different from your machine. Guards and covers might have been removed for illustrative purposes.

Continuing improvement and advancement of product design might have caused changes to your machine which are not included in this publication. Read, study, and keep this manual with the machine.

Whenever a question arises regarding your machine, or this publication, please consult your Cat dealer for the latest available information.

## **Safety**

The safety section lists basic safety precautions. In addition, this section identifies the text and locations of warning signs and labels used on the machine.

Read and understand the basic precautions listed in the safety section before operating or performing lubrication, maintenance, and repair on this machine.

## **Operation**

The operation section is a reference for the new operator and a refresher for the experienced operator. This section includes a discussion of gauges, switches, machine controls, attachment controls, transportation, and towing information.

Photographs and illustrations guide the operator through correct procedures of checking, starting, operating, and stopping the machine.

Operating techniques outlined in this publication are basic. Skill and techniques develop as the operator gains knowledge of the machine and its capabilities.

## **Maintenance**

The maintenance section is a guide to equipment care. The Maintenance Interval Schedule (MIS) lists the items to be maintained at a specific service interval. Items without specific intervals are listed under the "When Required" service interval. The Maintenance Interval Schedule lists the page number for the step-by-step instructions required to accomplish the scheduled maintenance. Use the Maintenance Interval Schedule as an index or "one safe source" for all maintenance procedures.

### **Maintenance Intervals**

Use the service hour meter to determine servicing intervals. Calendar intervals shown (daily, weekly, monthly, etc.) can be used instead of service hour meter intervals if the calendar intervals

provide more convenient servicing schedules and approximate the indicated service hour meter reading. Perform the recommended service at the interval that occurs first.

Under severe, dusty, or wet operating conditions, more frequent lubrication than is specified in the maintenance intervals chart might be necessary.

Perform service on items at multiples of the original requirement. For example, at every 500 service hours or 3 months, also service those items listed under every 250 service hours or monthly and every 10 service hours or daily.

## Certified Engine Maintenance

Proper maintenance and repair are essential to keep the engine and machine systems operating correctly. As the heavy-duty off-road diesel engine owner, you are responsible for the performance of the required maintenance listed in the Owner Manual, Operation and Maintenance Manual, and Service Manual.

It is prohibited for any person engaged in the business of repairing, servicing, selling, leasing, or trading engines or machines to remove, alter, or to render inoperative, any emission-related device or element of design installed on or in an engine or machine that is in compliance with all applicable regulations of the intended country to which it has been shipped. Certain elements of the machine and engine such as the exhaust system, fuel system, electrical system, intake air system, and cooling system may be emission-related and should not be altered unless approved by Caterpillar.

## Machine Capacity

Additional attachments or modifications may exceed machine design capacity which can adversely affect performance characteristics. Included would be stability and system certifications such as brakes, steering, and rollover protective structures (ROPS). Contact your Cat dealer for further information.

## Product Identification Number

Effective First Quarter 2001 the Product Identification Number (PIN) has changed from 8 to 17 characters. To provide uniform equipment identification, construction equipment manufacturers are moving to comply with the latest version of the product identification numbering standard. Non-road machine PINs are defined by ISO 10261. The new PIN format will apply to all machines and generator sets. The PIN plates and frame marking will display the 17 character PIN. The new format will look like the following:

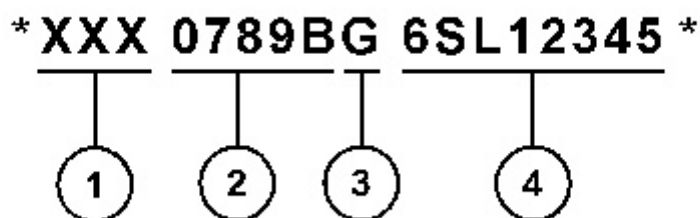

Where:

1. World Manufacturing Code (characters 1-3)
2. Machine Descriptor (characters 4-8)
3. Check Character (character 9)
4. Machine Indicator Section (MIS) or Product Sequence Number (characters 10-17). These were previously referred to as the Serial Number.

Machines and generator sets produced before First Quarter 2001 will maintain their 8 character PIN format.

Components such as engines, transmissions, axles, and work tools will continue to use an 8 character Serial Number (S/N).

---

Product: EXCAVATOR

Model: 320D2 EXCAVATOR XCC

Configuration: 320D2 L Excavator XCC00001-UP (MACHINE) POWERED BY C7.1 Engine

## Operation and Maintenance Manual

### 320D2 Excavator

Media Number -SEBU9247-08

Publication Date -01/09/2015

Date Updated -24/08/2018

i05829864

## Safety Messages

SMCS - 7000; 7405

There are several specific safety messages on this machine. The exact location of the hazards and the description of the hazards are reviewed in this section. Please become familiarized with all safety messages.

Make sure that all of the safety messages are legible. Clean the safety messages or replace the safety messages if you cannot read the words. Replace the illustrations if the illustrations are not visible. When you clean the safety messages, use a cloth, water, and soap. Do not use solvent, gasoline, or other harsh chemicals to clean the safety messages. Solvents, gasoline, or harsh chemicals could loosen the adhesive that secures the safety message. Loose adhesive will allow the safety message to fall.

Replace any safety message that is damaged, or missing. If a safety message is attached to a part that is replaced, install a safety message on the replacement part. Any Caterpillar dealer can provide new safety messages.

---

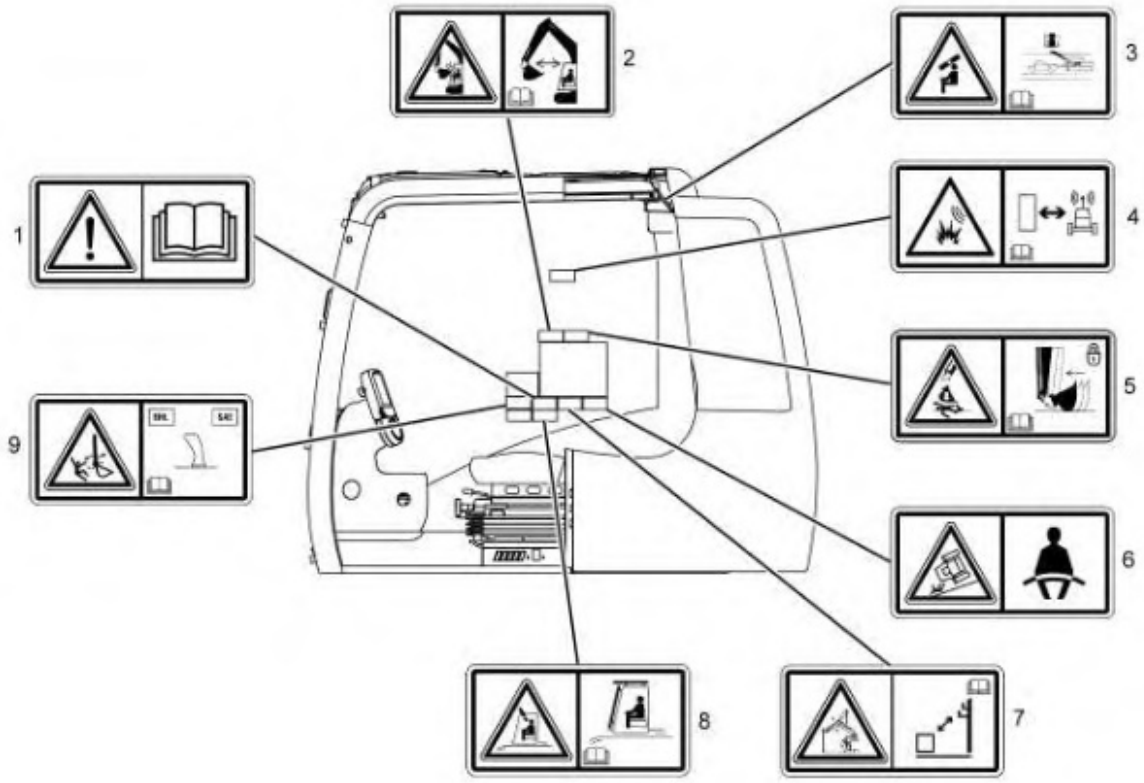

Illustration 1

g03331197

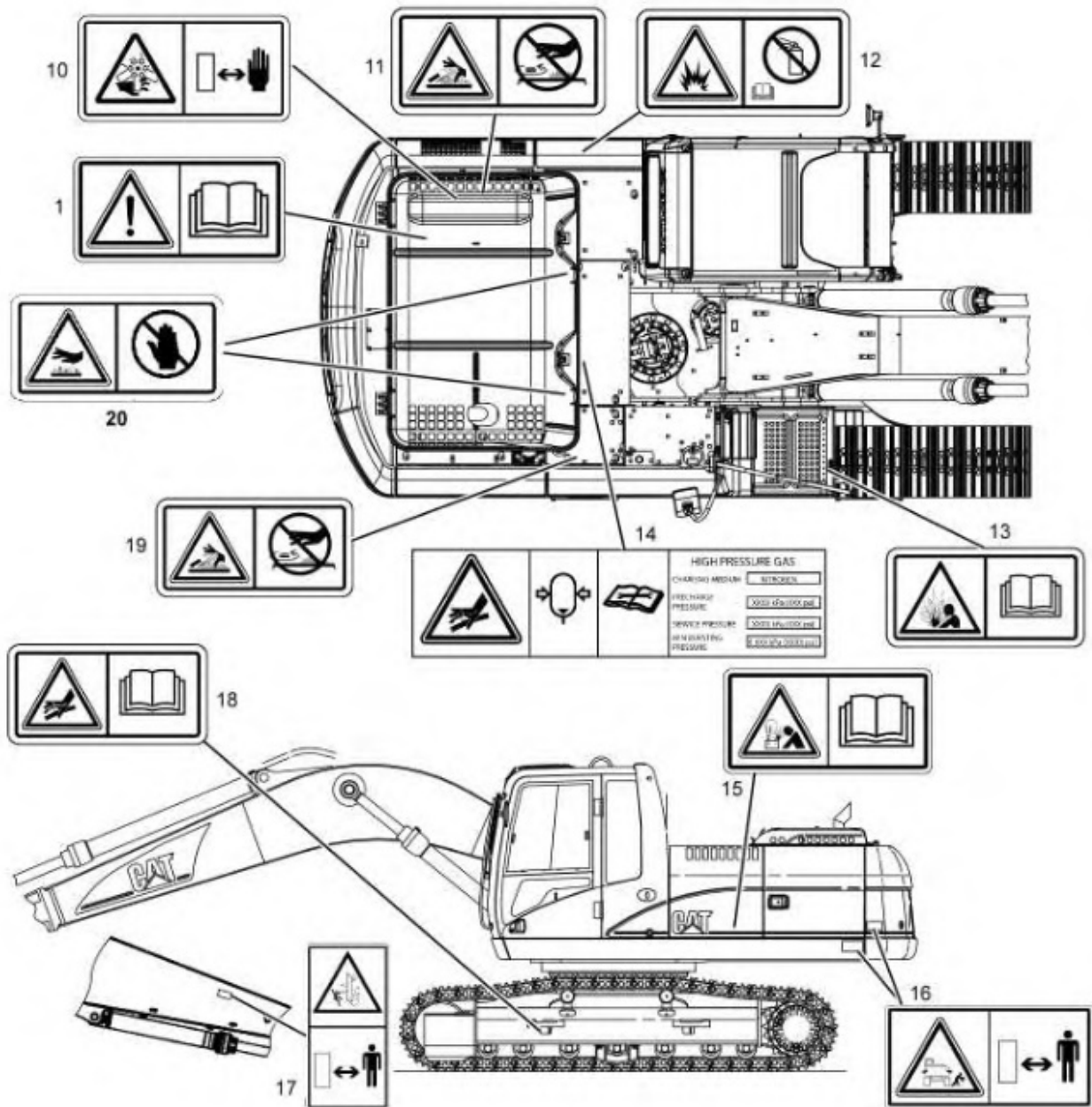

Illustration 2

g03331198

**Do Not Operate (1)**

This safety message is located in the cab and also on the engine.

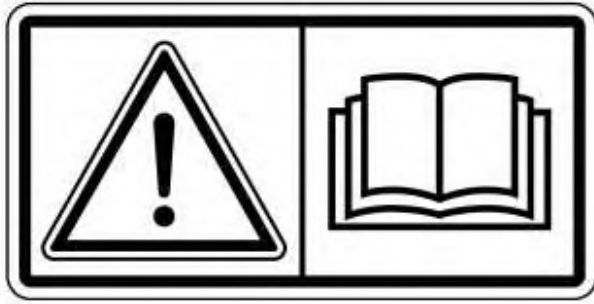

Illustration 3

g01370904

 **WARNING**

**Do not operate or work on this equipment unless you have read and understand the instructions and warnings in the Operation and Maintenance Manual. Failure to follow the instructions or heed the warnings could result in injury or death. Contact any Cat dealer for replacement manuals. Proper care is your responsibility.**

### Crushing Hazard (2)

This safety message is located in the cab on the right side window.

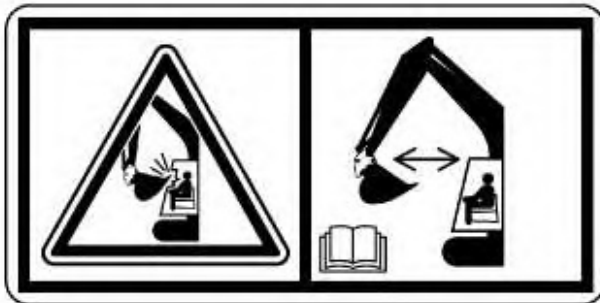

Illustration 4

g01373971

 **WARNING**

**Crushing Hazard! Certain machine front linkage combinations (boom, stick, quick coupler, work tool) may require keeping the work tool away from the cab during operation. Personal injury or death may result if the work tool contacts the cab during operation.**



---

Refer to Operation and Maintenance Manual, "Operating Technique Information" for further information.

### Crushing Hazard (3)

This safety message is located in the cab.



Illustration 5

g01373978



**Personal injury can result if the window is not latched in the overhead position; ensure the auto lock is engaged.**

---

### Product Link (4)

If equipped, this safety message is positioned in the cab on the left side door post.

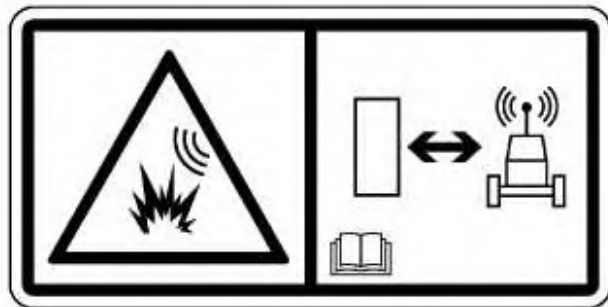

Illustration 6

g01370917

## **WARNING**

**This machine is equipped with a Caterpillar Product Link communication device. When electric detonators are used, this communication device should be deactivated within 12 m (40 ft) of a blast site for satellite-based systems and within 3 m (10 ft) of a blast site for cellular based systems, or within the distance mandated under applicable legal requirements. Failure to do so could cause interference with blasting operations and result in serious injury or death.**

**In cases where the type of Product Link module cannot be identified, Caterpillar recommends that the device be disabled no less than 12 m (40 ft) from the blast perimeter.**

---

Refer to Operation and Maintenance Manual , "Product Link" for further information.

### **Crushing Injury (5)**

If equipped, this safety message is located in the cab on the right side window.

---



Illustration 7

g01374035

## **WARNING**

**Crush injury. Could cause serious injury or death. Always confirm that the quick coupler is engaged onto the pins. Read the Operator's Manual.**

---

Refer to Operation and Maintenance Manual, "Quick Coupler Operation" for further information.

### **Seat Belt (6)**

This safety message is located in the cab.

---



Illustration 8

g01370908

## **WARNING**

**A seat belt should be worn at all times during machine operation to prevent serious injury or death in the event of an accident or machine overturn. Failure to wear a seat belt during machine operation may result in serious injury or death.**

## **Electrical Power Lines (7)**

This safety message is located in the cab.

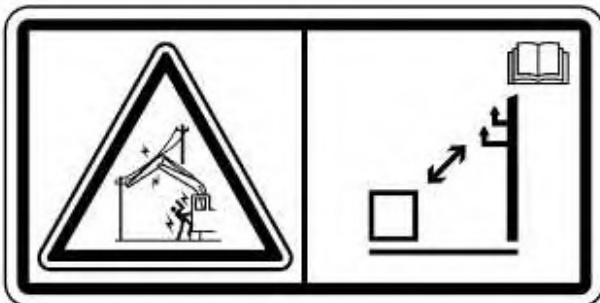

Illustration 9

g01374045

## **DANGER**

**Electrocution Hazard! Keep the machine and attachments a safe distance from electrical power. Stay clear 3 m (10 ft) plus twice the line insulator length. Read and understand the instructions and warnings in the**

**Operation and Maintenance Manual. Failure to follow the instructions and warnings will cause serious injury or death**

---

**Crushing Hazard (8)**

This safety message is located in the cab.

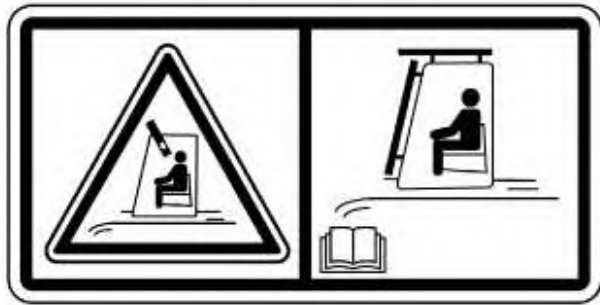

Illustration 10

g01374048



**The impact from objects that strike the front of the cab or the top of the cab could result in a crushing hazard with the potential for personal injury or death.**

**The front guard and the top guard should be installed on the cab for applications where the hazard of falling objects exist. Read the Operation and Maintenance Manual.**

---

Refer to Operation and Maintenance Manual, "Guards" for further information.

**Joystick Controls Alternate Patterns (9)**

If equipped, this safety message is located in the cab on the right side window.

---



Illustration 11

g01374050

 **WARNING**

**Crush Hazard. Improper joystick setting could cause possible unexpected movement of the boom, stick, or worktool which could result in serious injury or death. Confirm that the joystick settings are properly configured before you operate the machine. Read the Operation and Maintenance Manual.**

Refer to Operation and Maintenance Manual, "Joystick Controls Alternate Patterns" for further information.

**Rotating Fan (10)**

This safety message is located near the engine fan.

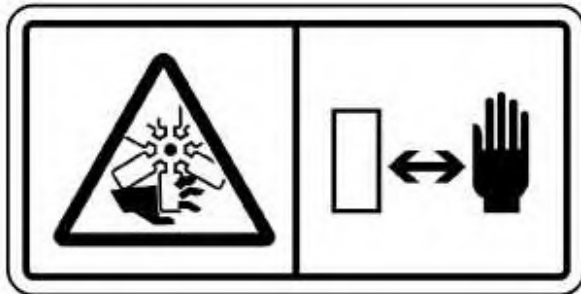

Illustration 12

g01385578

 **WARNING**

**Cutting Hazard! Keep hands clear of fan while engine is running. May cause serious injury or death.**

---

### Pressurized System (11)

This safety message is located on top of the radiator, next to the filler cap.

---



Illustration 13

g01371640



**Pressurized system! Hot coolant can cause serious burns, injury or death. To open the cooling system filler cap, stop the engine and wait until the cooling system components are cool. Loosen the cooling system pressure cap slowly in order to relieve the pressure. Read and understand the Operation and Maintenance Manual before performing any cooling system maintenance.**

---

### Aerosol Starting Aid (12)

This safety message is located inside the left front compartment on the engine air filter.

---





**Explosion hazard! Do not use ether! This machine is equipped with an air inlet heater. Using ether can create explosions or fires that can cause personal injury or death. Read and follow the starting procedure in the Operation and Maintenance Manual.**

---

Refer to Operation and Maintenance Manual, "Engine Starting" for further information.

### **Vapor Explosion (13)**

If equipped, this safety message is located on the storage compartment for the fuel transfer pump.

---

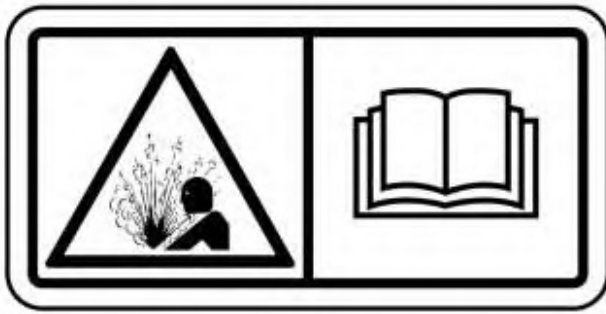

**Explosion hazard! Fuel vapors can accumulate in the refueling pump compartment and can be ignited by improper operation of the refueling pump. Failure to follow the operating instructions for the refueling pump could result in personal injury or death. Read and follow the operating instructions for the refueling pump in the Operation and Maintenance Manual.**

---

Refer to Operation and Maintenance Manual, "Fuel Transfer Pump (Refueling)" for further information.

### **High Pressure Gas (14)**

This safety message is located on the accumulator in the right back compartment.

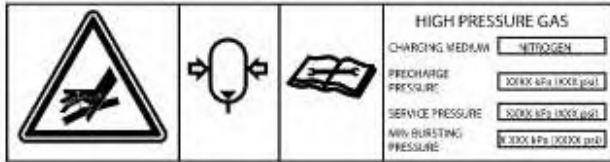

Illustration 16

g01374065



### **Pressurized System!**

**Hydraulic accumulators contain gas and oil under high pressure. DO NOT disconnect lines or disassemble any component of a pressurized accumulator. All gas pre-charge must be removed from the accumulator as instructed by the service manual before servicing the accumulator or any accumulator component.**

**Failure to follow the instructions and warnings could result in personal injury or death.**

**Only use dry nitrogen gas to recharge accumulators. See your Cat dealer for special equipment and detailed information for accumulator service and charging.**

---

Refer to Operation and Maintenance Manual, "Equipment Lowering with Engine Stopped" for further information.

### **Jump Start Cables (15)**

This safety message is located inside the left front compartment.

---



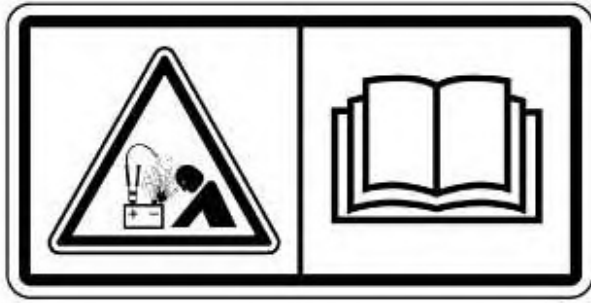

Illustration 17

g01370909

 **WARNING**

**Explosion Hazard! Improper jumper cable connections can cause an explosion resulting in serious injury or death. Batteries may be located in separate compartments. Refer to the Operation and Maintenance Manual for the correct jump starting procedure.**

Refer to Operation and Maintenance Manual, "Engine Starting with Jump Start Cables" for further information.

**Crushing Hazard (16)**

This safety message is located on both sides of the back end of the machine.

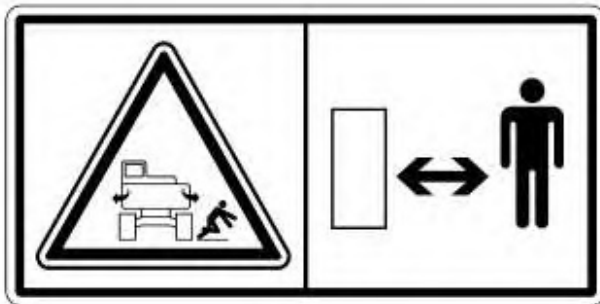

Illustration 18

g01374060

 **WARNING**

**Machine swings. Stay back. Crushing hazard could cause serious injury or death.**

---

### Crushing Hazard (17)

This safety message is located on both sides of the stick.

---

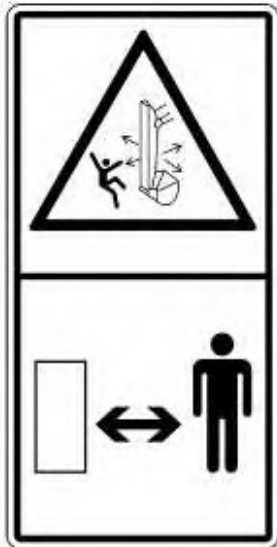

---

Illustration 19

g01385579

 **WARNING**

**A crushing hazard exists when the stick and boom are in motion and when the machine is being used in object handling applications. Failure to stay clear of the stick and boom when the machine is in operation can result in personal injury or death. Stay clear of the stick and boom when the machine is in operation.**

---

### High Pressure Cylinder (18)

This safety message is located on the track adjuster.

---

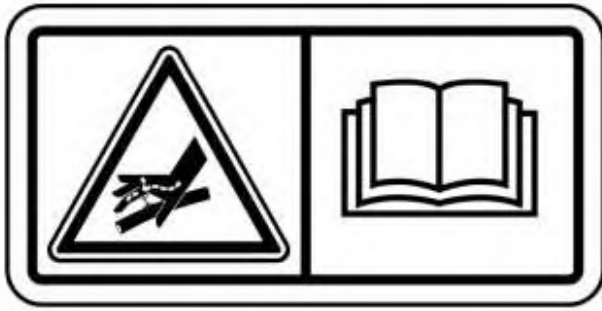

Illustration 20

g01371642

 **WARNING**

**High Pressure Cylinder. Do not remove any parts from the cylinder until all of the pressure has been relieved. This will prevent possible personal injury or death.**

Refer to Operation and Maintenance Manual , "Track Adjustment - Adjust" for the proper service procedure.

**Relieve Hydraulic Tank Pressure (19)**

This safety message is located on top of the hydraulic tank.



Illustration 21

g01371640

 **WARNING**

**HYDRAULIC TANK**

**RELIEVE TANK PRESSURE WITH ENGINE OFF BY REMOVING  
CAP SLOWLY TO PREVENT BURNS FROM HOT OIL.**

---

**Hot Surface (20)**

This safety message is located in two locations on the engine hood.

---



Illustration 22

g01372256



**Hot parts or hot components can cause burns or personal injury. Do not allow hot parts or components to contact your skin. Use protective clothing or protective equipment to protect your skin.**

---

---

Product: EXCAVATOR

Model: 320D2 EXCAVATOR XCC

Configuration: 320D2 L Excavator XCC00001-UP (MACHINE) POWERED BY C7.1 Engine

## Operation and Maintenance Manual 320D2 Excavator

Media Number -SEBU9247-08

Publication Date -01/09/2015

Date Updated -24/08/2018

i05199048

### Additional Messages

SMCS - 7000; 7405

There are several specific messages on this machine. The exact location of the messages and the description of the information are reviewed in this section. Please become familiar with all messages.

Make sure that all of the messages are legible. Clean the messages or replace the messages if you cannot read the words. Replace the illustrations if the illustrations are not legible. When you clean the messages, use a cloth, water, and soap. Do not use solvent, gasoline, or other harsh chemicals to clean the messages. Solvents, gasoline, or harsh chemicals could loosen the adhesive that secures the messages. Loose adhesive will allow the messages to fall.

Replace any message that is damaged, or missing. If a message is attached to a part that is replaced, install a message on the replacement part. Any Caterpillar dealer can provide new messages.

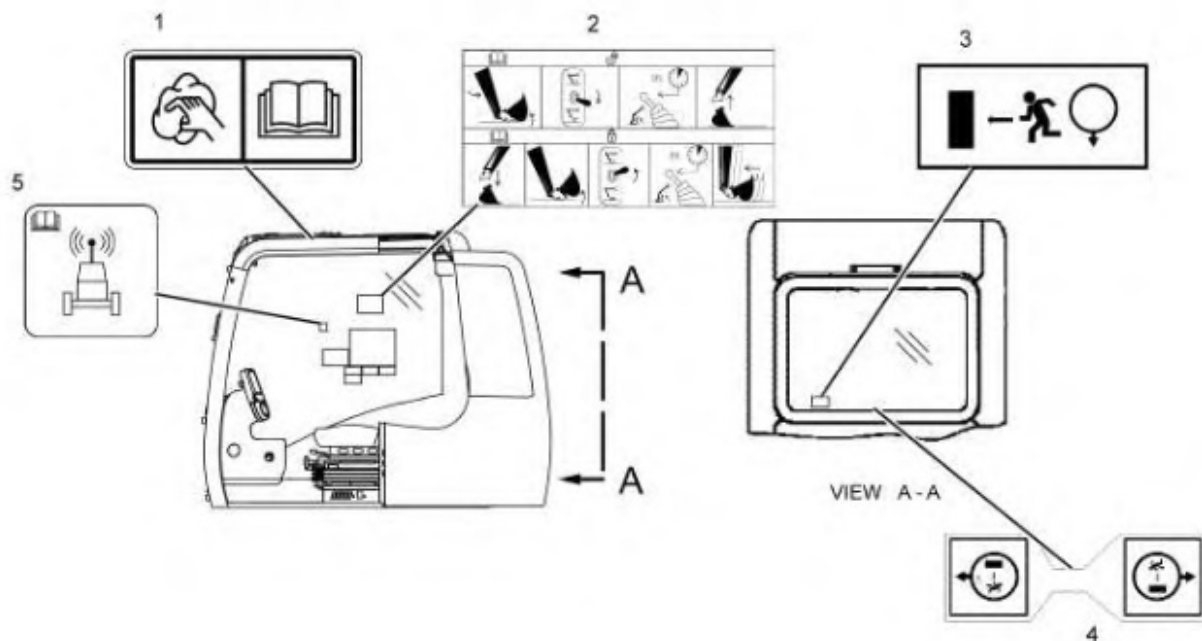

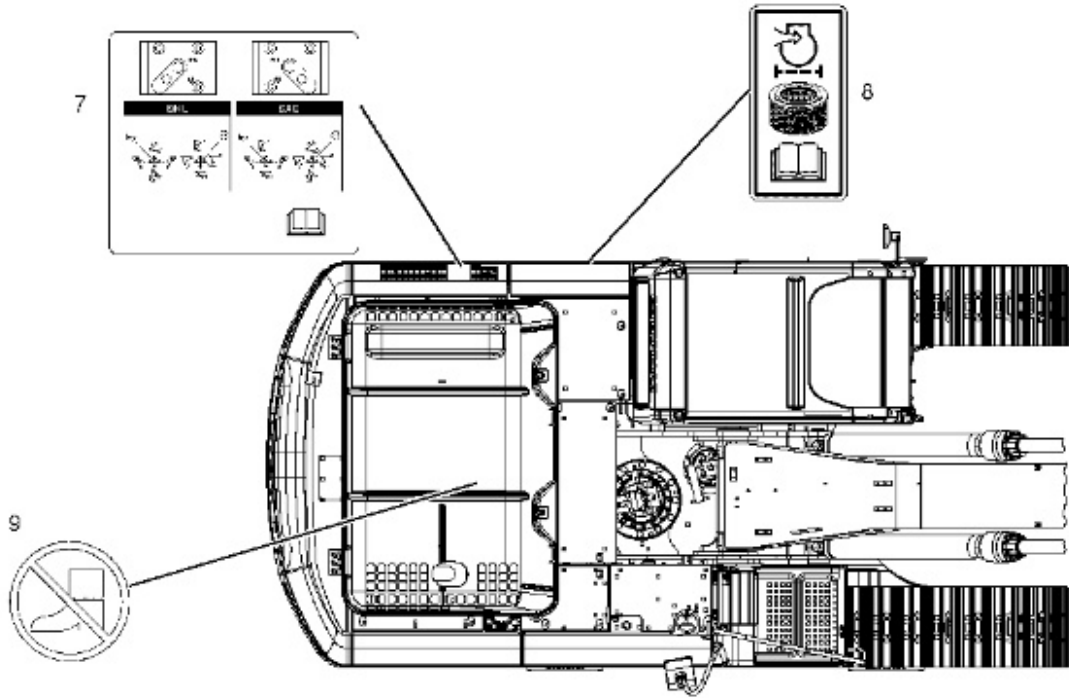

Illustration 2

**(1) Cleaning Windows**

This message is located on the overhead window in the cab.

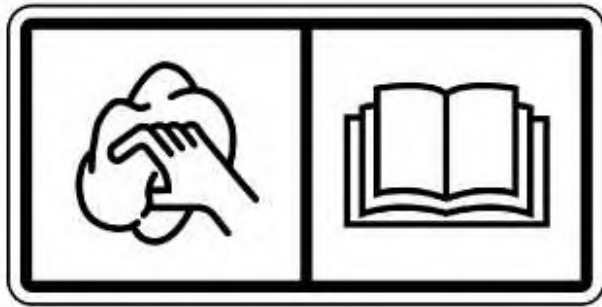

Illustration 3

**NOTICE**

**Clean windows with a wet cloth or sponge. Dry cloth or sponge may scratch window material.**

## (2) Quick Coupler

This message is located in the cab on the right side window.

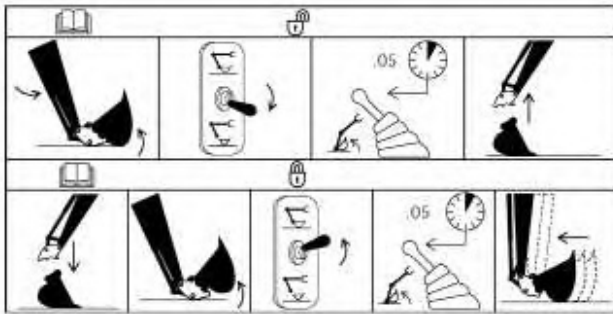

Illustration 4

g01231702

Read the Operation and Maintenance Manual.

Perform the steps that are illustrated on the message in order to unlock the coupler.

Perform the steps that are illustrated on the message in order to lock the coupler.

When the coupler is installed, use care when you move the stick or the bucket.

Refer to Operation and Maintenance Manual, "Quick Coupler Operation" for further information.

## (3) Alternate Exit

This message is located on the rear window in the cab.

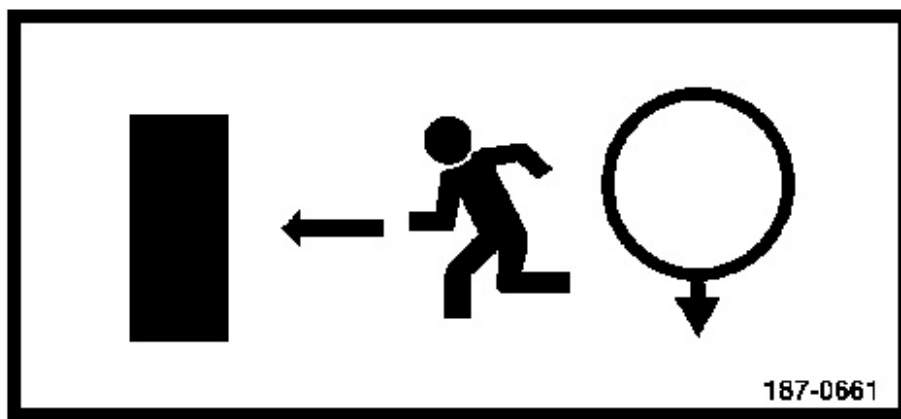

Illustration 5

g00915906

If the primary exits are blocked, pull the ring in order to open the rear window. Exit the machine through the window.

Refer to Operation and Maintenance Manual, "Alternate Exit" for further information.

#### (4) Ring for the Alternate Exit

This message is located on the ring for the alternate exit.

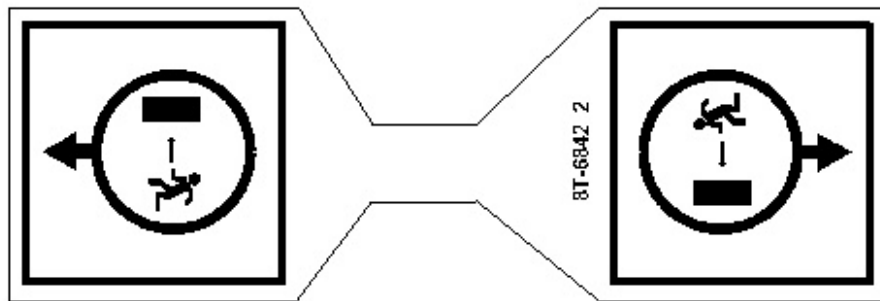

Illustration 6

g00915912

Pull the ring in order to open the alternate exit.

Refer to Operation and Maintenance Manual, "Alternate Exit" for further information.

#### (5) Data Privacy

This message is located on the window.



Illustration 7

g01418953



The Product Link System is a satellite communication device that transmits information regarding the machine back to Caterpillar and Caterpillar dealers and customers. All logged events and diagnostic codes that are available to the Caterpillar Electronic Technician (ET) on the CAT data link can be sent to the satellite. Information can also be sent to the Product Link System. The information is used to improve Caterpillar products and Caterpillar services.

Refer to Operation and Maintenance Manual, "Product Link" for more information.

### (6) Alternate Joystick Control Patterns

This message is located behind the left side rear access door.

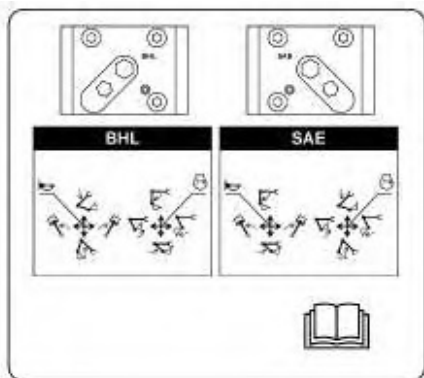

Illustration 8

g01233974

The machine control pattern can easily be changed to the SAE system or to the standard backhoe loader hydraulic system (BHL) by changing the position of the two-way valve (if equipped).

Refer to Operation and Maintenance Manual, "Joystick Controls Alternate Patterns" for further information.

### (7) Radial Seal Air Filters

This message is located on the air cleaner.



Thank you so much for reading.  
Please click the “Buy Now!”  
button below to download the  
complete manual.



After you pay.

You can download the most  
perfect and complete manual in  
the world immediately.

Our support email:

[ebooklibonline@outlook.com](mailto:ebooklibonline@outlook.com)