

Product: BACKHOE LOADER

Model: 416C BACKHOE LOADER 1XR

Configuration: 416C Backhoe Loader Center Pivot, Parallel Lift 1XR02250-02261 (MACHINE) POWERED BY 3054 Engine

Operation and Maintenance Manual 416C, 426C, 428C, 436C and 438C Backhoe Loaders

Media Number -SEBU6873-05

Publication Date -01/07/2008

Date Updated -14/07/2008

s00037320

Foreword

SMCS - 7606

Literature Information

This manual should be stored in the operator's compartment in the literature holder or seat back literature storage area.

This manual contains safety information, operation instructions, transportation information, lubrication information and maintenance information.

Some photographs or illustrations in this publication show details or attachments that can be different from your machine. Guards and covers might have been removed for illustrative purposes.

Continuing improvement and advancement of product design might have caused changes to your machine which are not included in this publication. Read, study and keep this manual with the machine.

Whenever a question arises regarding your machine, or this publication, please consult your Cat dealer for the latest available information.

Safety

The safety section lists basic safety precautions. In addition, this section identifies the text and locations of warning signs and labels used on the machine.

Read and understand the basic precautions listed in the safety section before operating or performing lubrication, maintenance and repair on this machine.

Operation

The operation section is a reference for the new operator and a refresher for the experienced operator. This section includes a discussion of gauges, switches, machine controls, attachment controls, transportation and towing information.

Photographs and illustrations guide the operator through correct procedures of checking, starting, operating and stopping the machine.

Operating techniques outlined in this publication are basic. Skill and techniques develop as the operator gains knowledge of the machine and its capabilities.

Maintenance

The maintenance section is a guide to equipment care. The Maintenance Interval Schedule (MIS) lists the items to be maintained at a specific service interval. Items without specific intervals are listed under the "When Required" service interval. The Maintenance Interval Schedule lists the page number for the step-by-step instructions required to accomplish the scheduled maintenance. Use the Maintenance Interval Schedule as an index or "one safe source" for all maintenance procedures.

Maintenance Intervals

Use the service hour meter to determine servicing intervals. Calendar intervals shown (daily, weekly, monthly, etc.) can be used instead of service hour meter intervals if they provide more convenient servicing schedules and approximate the indicated service hour meter reading. Recommended service should always be performed at the interval that occurs first.

Under extremely severe, dusty or wet operating conditions, more frequent lubrication than is specified in the maintenance intervals chart might be necessary.

Perform service on items at multiples of the original requirement. For example, at every 500 service hours or 3 months, also service those items listed under every 250 service hours or monthly and every 10 service hours or daily.

California Proposition 65 Warning

Diesel engine exhaust and some of its constituents are known to the State of California to cause cancer, birth defects, and other reproductive harm.

Battery posts, terminals and related accessories contain lead and lead compounds. **Wash hands after handling.**

Certified Engine Maintenance

Proper maintenance and repair is essential to keep the engine and machine systems operating correctly. As the heavy duty off-road diesel engine owner, you are responsible for the performance of the required maintenance listed in the Owner Manual, Operation and Maintenance Manual, and Service Manual.

It is prohibited for any person engaged in the business of repairing, servicing, selling, leasing, or trading engines or machines to remove, alter, or render inoperative any emission related device or element of design installed on or in an engine or machine that is in compliance with the

regulations (40 CFR Part 89). Certain elements of the machine and engine such as the exhaust system, fuel system, electrical system, intake air system and cooling system may be emission related and should not be altered unless approved by Caterpillar.

Machine Capacity

Additional attachments or modifications may exceed machine design capacity which can adversely affect performance characteristics. Included would be stability and system certifications such as brakes, steering, and rollover protective structures (ROPS). Contact your Cat dealer for further information.

Cat Product Identification Number

Effective First Quarter 2001 the Cat Product Identification Number (PIN) has changed from 8 to 17 characters. In an effort to provide uniform equipment identification, Caterpillar and other construction equipment manufacturers are moving to comply with the latest version of the product identification numbering standard. Non-road machine PINs are defined by ISO 10261. The new PIN format will apply to all Cat machines and generator sets. The PIN plates and frame marking will display the 17 character PIN. The new format will look like the following:



Illustration 1

g00751314

Where:

1. Caterpillar's World Manufacturing Code (characters 1-3)
2. Machine Descriptor (characters 4-8)
3. Check Character (character 9)
4. Machine Indicator Section (MIS) or Product Sequence Number (characters 10-17). These were previously referred to as the Serial Number.

Machines and generator sets produced before First Quarter 2001 will maintain their 8 character PIN format.

Components such as engines, transmissions, axles, etc. and work tools will continue to use an 8 character Serial Number (S/N).

Product: BACKHOE LOADER

Model: 416C BACKHOE LOADER 1XR

Configuration: 416C Backhoe Loader Center Pivot, Parallel Lift 1XR02250-02261 (MACHINE) POWERED BY 3054 Engine

Operation and Maintenance Manual 416C, 426C, 428C, 436C and 438C Backhoe Loaders

Media Number -SEBU6873-05

Publication Date -01/07/2008

Date Updated -14/07/2008

i03150003

Safety Messages

SMCS - 7000; 7405

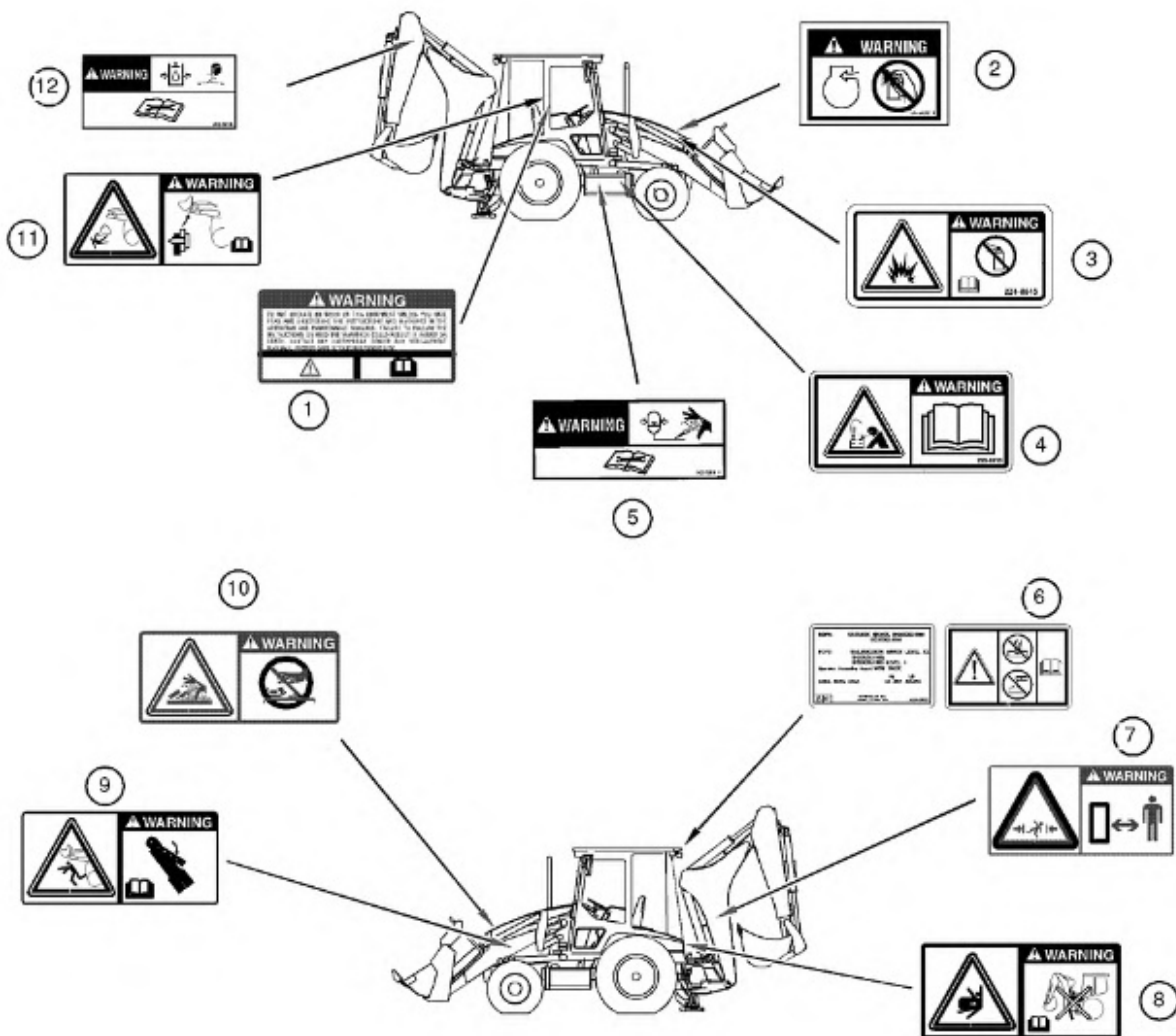

There are several specific safety messages on this machine. The exact location of the hazards and the description of the hazards are reviewed in this section. Please become familiarized with all safety messages.

Make sure that all of the safety messages are legible. Clean the safety messages or replace the safety messages if you cannot read the words. Replace the illustrations if the illustrations are not legible. When you clean the safety messages, use a cloth, water and soap. Do not use solvent, gasoline, or other harsh chemicals to clean the safety messages. Solvents, gasoline, or harsh chemicals could loosen the adhesive that secures the safety message. Loose adhesive will allow the safety message to fall.

Replace any safety message that is damaged, or missing. If a safety message is attached to a part that is replaced, install a safety message on the replacement part. Any Caterpillar dealer can provide new safety messages.

Do Not Operate (1)



Illustration 2

g00930652

This safety message is located above the right side console.



Do not operate or work on this machine unless you have read and understand the instructions and warnings in the Operation and Maintenance Manuals. Failure to follow the instructions or heed the warnings could result in injury or death. Contact your Caterpillar dealer for replacement manuals. Proper care is your responsibility.

No Ether In Air Inlet (2)



Illustration 3

g00924889

This safety message is located on the valve cover.



If equipped with an air inlet heater (AIH) for cold weather starting, do not use aerosol types of starting aids such as ether. Such use could result in an explosion and personal injury.

Ether (3)



Illustration 4

g00931562

This safety message is located under the hood for the engine compartment.



Explosion hazard! Do not use ether! This machine is equipped with an air inlet heater. Using ether can create explosions or fires that can cause personal injury or death. Read and follow the starting procedure in the Operation and Maintenance Manual.

Batteries (4)



This safety message is located on the inside of the door for the battery compartment.



Explosion Hazard! Improper jumper cable connections can cause an explosion resulting in serious injury or death. Batteries may be located in separate compartments. When using jump start cables, always connect the positive (+) cable from the source to the positive (+) terminal of the battery that is connected to the starter solenoid. Connect the negative (-) cable from the source to the negative (-) terminal of the starter. If the machine is not equipped with a starter negative terminal, connect the negative (-) cable to the engine block. Follow the procedure in the Operation and Maintenance Manual.

High Pressure Accumulator (5)

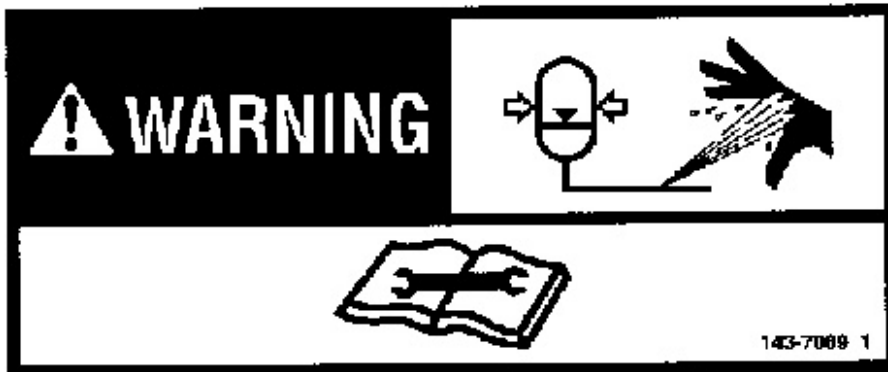

This safety message is located on the accumulator for the loader. This accumulator is located behind the battery compartment.



Hydraulic accumulator contains gas and oil under high pressure. Improper removal or repair procedures could cause severe injury. To

remove or repair, instructions in the service manual must be followed. Special equipment is required for testing and charging.

ROPS (6)



Illustration 7

g01033008

This safety message is located on the back of the cab.

WARNING

Structural damage, an overturn, modification, alteration, or improper repair can impair this structure's protection capability thereby voiding this certification. Do not weld on or drill holes in the structure. Consult a Caterpillar dealer to determine this structure's limitations without voiding its certification.

Crush Hazard (7)



Illustration 8

g00930663

This safety message is located on the boom above the boom foot pin and sideways from the bottom wrapper plate.



Crushing Hazard! Stay back a safe distance. There is no clearance for a person in this area when the machine turns. Failure to follow these instructions could cause serious injury or death.

Keep Clear (8)



This safety message is located on the back of the cab.



Crush hazard; This is not an entrance or exit. Stay clear of this area when the machine is operating. Start and operate the backhoe from the operator seat only. Failure to follow these warnings could result in injury or death.

Brace The Lift Cylinder (9)



This safety message (if equipped) is located on the loader lift arm by the brace for the loader lift arm.



When performing any work underneath a raised loader lift arm, the loader lift arm brace must be in place. Install the loader lift arm brace as follows.

- 1. Empty loader bucket. Remove pin that secures loader lift arm brace to left loader arm. Raise loader arms to maximum height with the bucket in the dump position.**

2. Position service brace over left lift cylinder with flat end against cylinder end.
3. Push pin through holes of loader lift arm brace and install cotter pin.
4. Slowly lower loader arms until brace contacts the top of the lift cylinder and bosses on loader arm.
5. To remove loader lift arm brace, reverse procedure.

Failure to follow this procedure can result in death or serious injury if the loader arms are accidentally lowered.

Pressurized System (10)



Illustration 11

g00930639

This safety message is located in two locations by the cooling system filler cap.



Pressurized system: Hot coolant can cause serious burn. To open cap, stop engine, wait until radiator is cool. Then loosen cap slowly to relieve the pressure.

Improper Attachment of Work Tools (11)



Illustration 12

g01032986

This safety message is located above the right side console.



Improper attachment of implements could result in injury or death.

Do not operate this machine until you have positive indication that the coupler pins are fully engaged. Follow recommended procedure in Operation and Maintenance Manual.

High Cylinder Pressure (12)



Illustration 13

g00997730

This safety message is located on the right side of the boom near the connection with the stick.



High Pressure Cylinder. Failure to read and follow these instructions can cause rapidly discharging gas and/or hydraulic fluid which can result in death, personal injury and property damage.

Product: BACKHOE LOADER

Model: 416C BACKHOE LOADER 1XR

Configuration: 416C Backhoe Loader Center Pivot, Parallel Lift 1XR02250-02261 (MACHINE) POWERED BY 3054 Engine

Operation and Maintenance Manual 416C, 426C, 428C, 436C and 438C Backhoe Loaders

Media Number -SEBU6873-05

Publication Date -01/07/2008

Date Updated -14/07/2008

i03150004

Additional Messages

SMCS - 7000; 7405

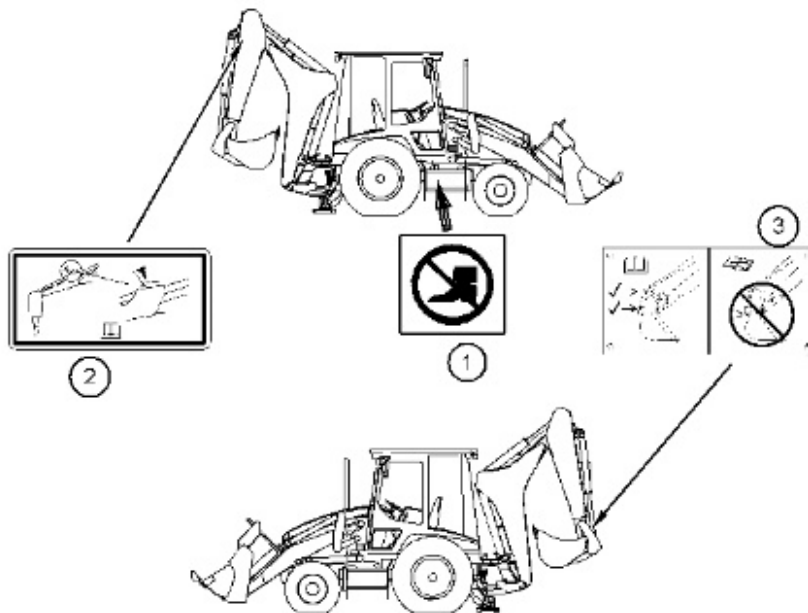

Illustration 1

g01190217

No Step (1)



Illustration 2

g00936182

This message is located inside the battery box.



Do not step here. Stepping here could cause damage to the work tool and personal injury.

Pin the Extendable Stick (2)



This message is located on the stick.



The E-Stick must be pinned before using attachments, to prevent movement which could cause personal injury.

Improper Location of the Backhoe Bucket (3)



This message is located by the linkage for the backhoe bucket.



Improper bucket pin connection can cause machine damage. Make sure the bucket pins are connected properly.

Product: BACKHOE LOADER

Model: 416C BACKHOE LOADER 1XR

Configuration: 416C Backhoe Loader Center Pivot, Parallel Lift 1XR02250-02261 (MACHINE) POWERED BY 3054 Engine

Operation and Maintenance Manual 416C, 426C, 428C, 436C and 438C Backhoe Loaders

Media Number -SEBU6873-05

Publication Date -01/07/2008

Date Updated -14/07/2008

i00609983

General Hazard Information

SMCS - 7000



Illustration 1

g00037327

Before you service the machine or before you repair the machine, attach a "Do Not Operate" warning tag or a similar warning tag to the start switch or to the controls. These warning tags Special Instruction, SEHS7332 are available from your Caterpillar dealer.

Know the width of your equipment in order to maintain proper clearance near fences, boundary obstacles, etc.

Wear a hard hat, protective glasses and other protective equipment in order to accommodate job conditions.

Do not wear loose clothing or jewelry that can catch on controls or on other parts of the machine.

Ensure that all protective guards and all covers are secured in place on the machine.

Keep the machine free from foreign material. Check the deck, the walkways and the steps. Remove debris, oil, tools and other items.

Secure all loose items that are not a part of the machine. Secure lunch boxes, tools and other items.

Know the appropriate work site hand signals. Also, know the personnel that are authorized to give the hand signals. Accept signals from one person only.

Do not smoke when you service an air conditioner. Also, do not smoke if refrigerant gas may be present. Inhaling the fumes that are emitted from a flame that contacts air conditioner refrigerant can cause bodily harm or death. Inhaling gas from air conditioner refrigerant through a lighted cigarette can cause bodily harm or death.

Never put maintenance fluids into glass containers. Drain all liquids into a suitable container.

When you discard liquids, obey all local regulations.

Use all cleaning solutions with care.

Report all necessary repairs.

Do not allow unauthorized personnel on the machine.

Unless you are instructed otherwise, perform the maintenance with the following conditions:

- The machine is parked on level ground.
- The attachment controls are in HOLD position.
- The transmission control is in NEUTRAL position and the neutral lock is in the ON position.
- The parking brake is engaged.
- Lower the loader bucket until the loader bucket exerts a slight downward pressure onto the ground.
- The engine is stopped.
- The engine start switch in the OFF position and the key is removed.

Pressure Air

Pressure air can cause personal injury. When pressure air is used for cleaning, wear a protective face shield, protective clothing and protective shoes.

The maximum air pressure must be below 205 kPa (30 psi) for cleaning purposes.

Trapped Pressure

Pressure can be trapped in a hydraulic system. Trapped pressure can cause sudden machine movement or attachment movement. Use caution if you disconnect hydraulic lines or fittings. High pressure oil that is released can cause a hose to whip. High pressure oil that is released can cause oil to spray. Fluid penetration can cause serious injury and possible death.

Fluid Penetration

When you check for a leak, use a board or cardboard. Leaking fluid that is under pressure can penetrate body tissue. Fluid penetration can cause serious injury and possible death. A pin hole leak can cause severe injury. If fluid is injected into your skin, you must obtain treatment immediately. Seek treatment from a doctor that is familiar with this type of injury.

Asbestos Information

Caterpillar equipment and replacement parts that are shipped from Caterpillar are asbestos free. Caterpillar recommends the use of only genuine Caterpillar replacement parts. If any replacement parts that contain asbestos are used, the following guidelines should be used in handling these parts and asbestos debris.

Use caution. Avoid inhaling dust that might be generated when you handle components that contain asbestos fibers. If this dust is inhaled, it can be hazardous to your health. The components that may contain asbestos fibers are brake pads, brake bands, lining material, clutch plates, and some gaskets. The asbestos that is used in these components is usually bound in a resin or sealed in some way. Normal handling is not hazardous, unless airborne dust that contains asbestos is generated.

If dust which can contain asbestos is present, there are several guidelines that should be followed:

- Never use compressed air for cleaning.
 - Avoid sweeping materials that contain asbestos.
 - Also avoid grinding materials that contain asbestos.
 - Use a wet method in order to clean up asbestos materials.
 - You may also use a vacuum that is equipped with a highly efficient filter that cleans particulate air.
 - Use exhaust ventilation on permanent machining jobs.
 - Wear an approved respirator if there is no other way to control the dust.
 - Comply with applicable rules and regulations for the work place. In the USA, use Occupational Safety and Health Administration requirements. These OSHA requirements can be found in "29 CFR 1910.1001".
 - Obey environmental rules for the disposal of asbestos and obey environmental regulations for the disposal of asbestos.
 - Stay away from areas that might have asbestos particles in the air.
-

Thank you so much for reading.
Please click the “Buy Now!”
button below to download the
complete manual.



After you pay.

You can download the most
perfect and complete manual in
the world immediately.

Our support email:

ebooklibonline@outlook.com