

Product: BACKHOE LOADER
Model: 424B HD BACKHOE LOADER JRY
Configuration: 424B HD Backhoe Loader JRY00001-UP (MACHINE)

Operation and Maintenance Manual 424B HD Backhoe Loader

Media Number -SEBU9921-04

Publication Date -01/01/2015

Date Updated -11/10/2018

s03548206

Foreword

California Proposition 65 Warning

Diesel engine exhaust and some of its constituents are known to the State of California to cause cancer, birth defects, and other reproductive harm.



WARNING - This product can expose you to chemicals including ethylene glycol, which is known to the State of California to cause birth defects or other reproductive harm. For more information go to:

www.P65Warnings.ca.gov

Do not ingest this chemical. Wash hands after handling to avoid incidental ingestion.



WARNING - This product can expose you to chemicals including lead and lead compounds, which are known to the State of California to cause cancer, birth defects, or other reproductive harm. For more information go to:

www.P65Warnings.ca.gov

Wash hands after handling components that may contain lead.

Literature Information

This manual should be stored in the operator's compartment in the literature holder or seat back literature storage area.

This manual contains safety information, operation instructions, transportation information, lubrication information, and maintenance information.

Some photographs or illustrations in this publication show details or attachments that can be different from your machine. Guards and covers might have been removed for illustrative purposes.

Continuing improvement and advancement of product design might have caused changes to your machine which are not included in this publication. Read, study, and keep this manual with the machine.

Whenever a question arises regarding your machine, or this publication, please consult your Cat dealer for the latest available information.

Safety

The safety section lists basic safety precautions. In addition, this section identifies the text and locations of warning signs and labels used on the machine.

Read and understand the basic precautions listed in the safety section before operating or performing lubrication, maintenance, and repair on this machine.

Operation

The operation section is a reference for the new operator and a refresher for the experienced operator. This section includes a discussion of gauges, switches, machine controls, attachment controls, transportation, and towing information.

Photographs and illustrations guide the operator through correct procedures of checking, starting, operating, and stopping the machine.

Operating techniques outlined in this publication are basic. Skill and techniques develop as the operator gains knowledge of the machine and its capabilities.

Maintenance

The maintenance section is a guide to equipment care. The Maintenance Interval Schedule (MIS) lists the items to be maintained at a specific service interval. Items without specific intervals are listed under the "When Required" service interval. The Maintenance Interval Schedule lists the page number for the step-by-step instructions required to accomplish the scheduled maintenance. Use the Maintenance Interval Schedule as an index or "one safe source" for all maintenance procedures.

Maintenance Intervals

Use the service hour meter to determine servicing intervals. Calendar intervals shown (daily, weekly, monthly, etc.) can be used instead of service hour meter intervals if the calendar intervals

provide more convenient servicing schedules and approximate the indicated service hour meter reading. Perform the recommended service at the interval that occurs first.

Under severe, dusty, or wet operating conditions, more frequent lubrication than is specified in the maintenance intervals chart might be necessary.

Perform service on items at multiples of the original requirement. For example, at every 500 service hours or 3 months, also service those items listed under every 250 service hours or monthly and every 10 service hours or daily.

Certified Engine Maintenance

Proper maintenance and repair are essential to keep the engine and machine systems operating correctly. As the heavy-duty off-road diesel engine owner, you are responsible for the performance of the required maintenance listed in the Owner Manual, Operation and Maintenance Manual, and Service Manual.

It is prohibited for any person engaged in the business of repairing, servicing, selling, leasing, or trading engines or machines to remove, alter, or to render inoperative, any emission-related device or element of design installed on or in an engine or machine that is in compliance with all applicable regulations of the intended country to which it has been shipped. Certain elements of the machine and engine such as the exhaust system, fuel system, electrical system, intake air system, and cooling system may be emission-related and should not be altered unless approved by Caterpillar.

Machine Capacity

Additional attachments or modifications may exceed machine design capacity which can adversely affect performance characteristics. Included would be stability and system certifications such as brakes, steering, and rollover protective structures (ROPS). Contact your Cat dealer for further information.

Product Identification Number

Effective First Quarter 2001 the Product Identification Number (PIN) has changed from 8 to 17 characters. To provide uniform equipment identification, construction equipment manufacturers are moving to comply with the latest version of the product identification numbering standard. Non-road machine PINs are defined by ISO 10261. The new PIN format will apply to all machines and generator sets. The PIN plates and frame marking will display the 17 character PIN. The new format will look like the following:



Where:

1. World Manufacturing Code (characters 1-3)
2. Machine Descriptor (characters 4-8)
3. Check Character (character 9)
4. Machine Indicator Section (MIS) or Product Sequence Number (characters 10-17). These were previously referred to as the Serial Number.

Machines and generator sets produced before First Quarter 2001 will maintain their 8 character PIN format.

Components such as engines, transmissions, axles, and work tools will continue to use an 8 character Serial Number (S/N).

Product: BACKHOE LOADER
Model: 424B HD BACKHOE LOADER JRY
Configuration: 424B HD Backhoe Loader JRY00001-UP (MACHINE)

Operation and Maintenance Manual

424B HD Backhoe Loader

Media Number -SEBU9921-04

Publication Date -01/01/2015

Date Updated -11/10/2018

i06986646

Safety Messages

SMCS - 7000; 7405

There are several specific warning signs on this machine. The exact location of the hazards and the description of the hazards are reviewed in this section. Please become familiarized with all warning signs.

Make sure that all of the warning signs are legible. Clean the warning signs or replace the warning signs if you cannot read the words. Replace the illustrations if the illustrations are not legible. When you clean the warning signs, use a cloth, water, and soap. Do not use solvent, gasoline, or other harsh chemicals to clean the safety signs. Solvents, gasoline, or harsh chemicals could loosen the adhesive that secures the warning sign. Loose adhesive will allow the warning sign to fall.

Replace any safety sign that is damaged, or missing. If a safety sign is attached to a part that is replaced, install a safety sign on the replacement part. Any Cat dealer can provide new safety signs.

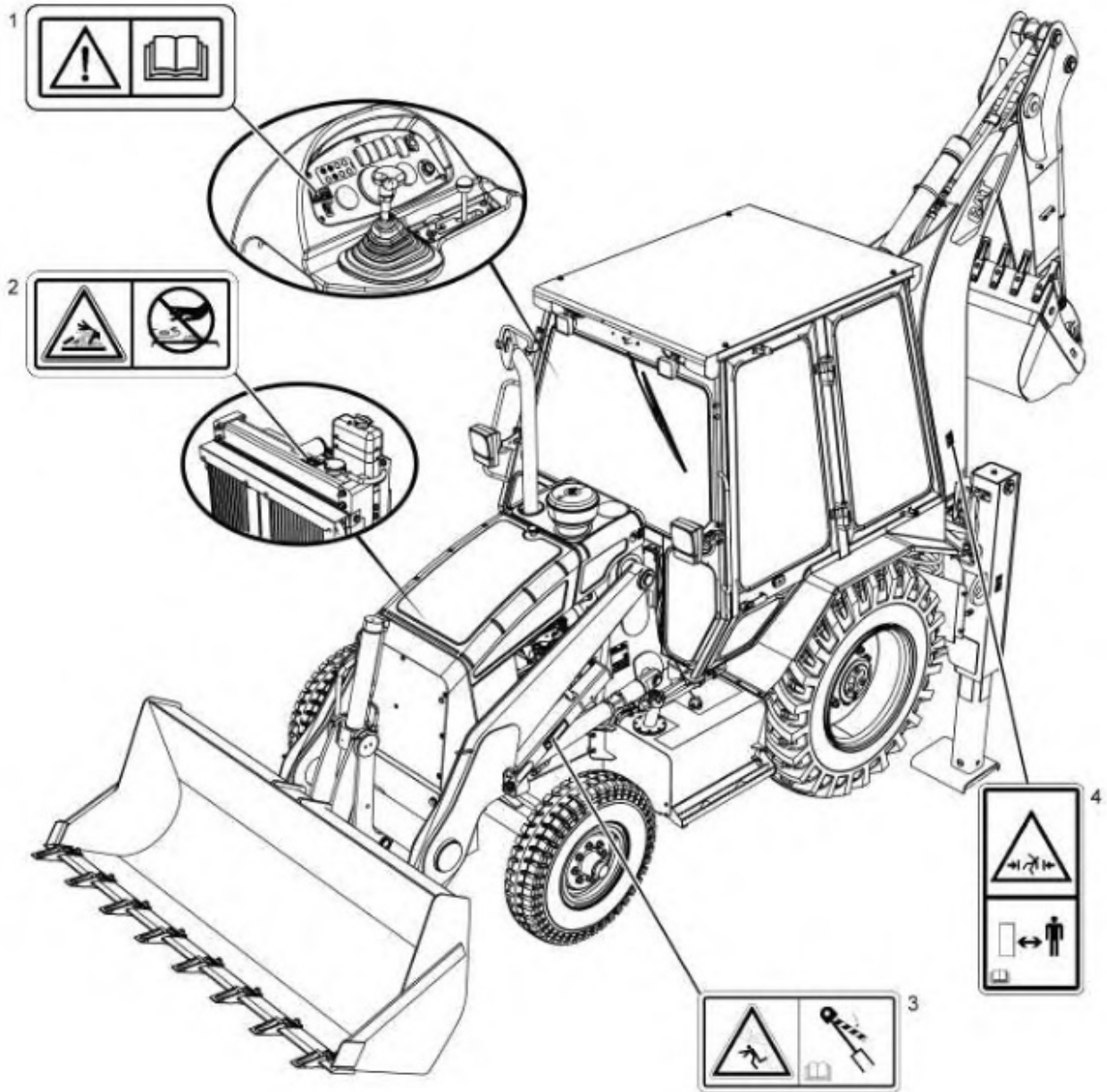

Illustration 1

g03778483

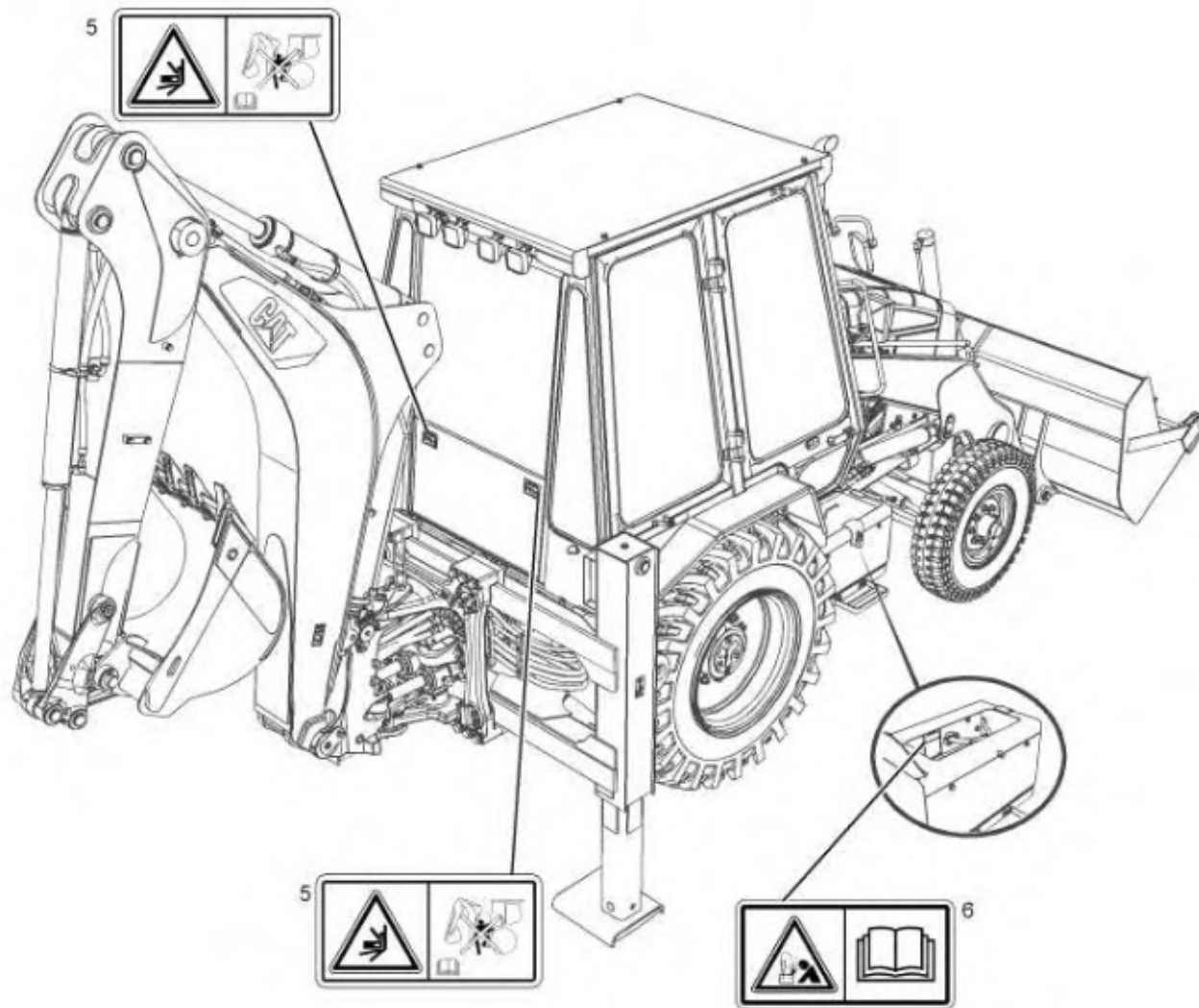
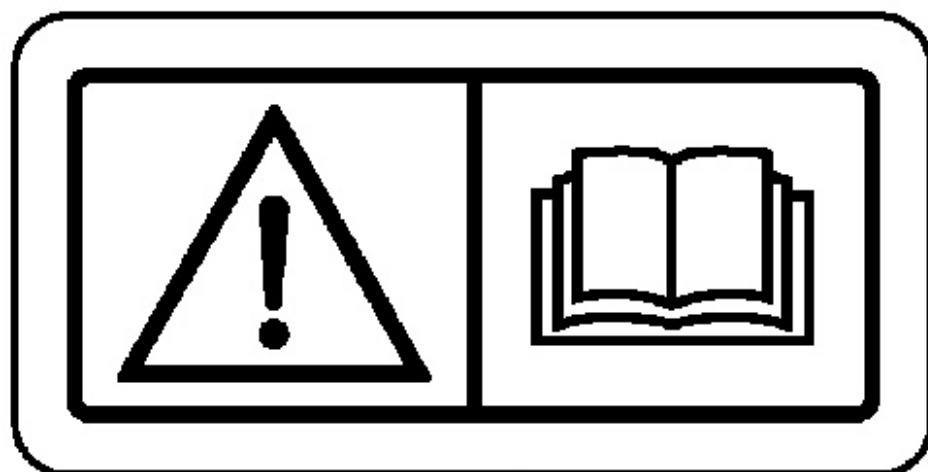

Illustration 2

g06187876

Do Not Operate (1)



This warning label is located inside the cab on the right side console.



Do not operate or work on this machine unless you have read and understand the instructions and warnings in the Operation and Maintenance Manuals. Failure to follow the instructions or heed the warnings could result in injury or death. Contact your Cat dealer for replacement manuals. Proper care is your responsibility.

Pressurized System (2)

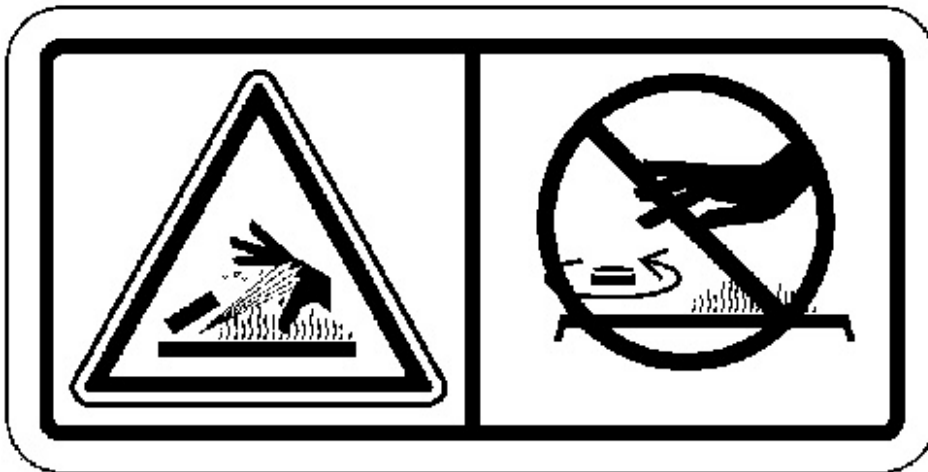

This warning label is located on Radiator top flange rear cap.



Pressurized system: Hot coolant can cause serious burn. To open cap, stop engine, wait until radiator is cool. Then loosen cap slowly to relieve the pressure.

Refer to Operation and Maintenance Manual, "Cooling System Coolant Level - Check" for further information.

Brace The Lift Cylinder on Single Tilt Machines (3)



Illustration 5

g03778487

This warning label is located on the safety brace attached to the loader lift arm.

WARNING

When performing any work underneath a raised loader lift arm, the loader lift arm brace must be in place. Install the loader lift arm brace as follows.

1. Empty loader bucket. Remove pin that secures loader lift arm brace to left loader arm. Raise the loader arms with the bucket in the dump position.
2. Position service brace over left lift cylinder with flat end against cylinder end.
3. Push pin through holes of loader lift arm brace and install cotter pin.
4. Slowly lower loader arms until brace contacts the top of the lift cylinder and bosses on loader arm.
5. To remove loader lift arm brace, reverse procedure.

Failure to follow this procedure can result in death or serious injury if the loader arms are accidentally lowered.

Crush Hazard (4)

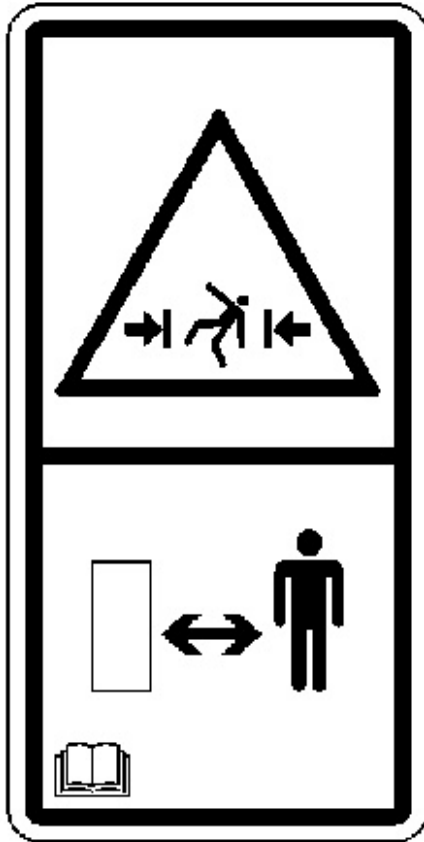

Illustration 6

g03778488

This warning label is located on both sides of the boom.



Crushing Hazard! Stay back a safe distance. There is no clearance for a person in this area when the machine turns. Failure to follow these instructions could cause serious injury or death.

Keep Clear (5)



Illustration 7

g03778491

This warning label is located outside the cab structure on either sides of the rear window at the bottom fixed glass.



Crush hazard; This is not an entrance or exit. Stay clear of this area when the machine is operating. Start and operate the backhoe from the operator seat only. Failure to follow these warnings could result in injury or death.

Batteries (6)

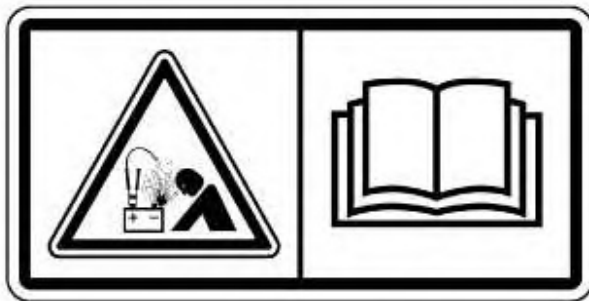

Illustration 8

g03778490

This warning label is located on the inside of the battery compartment.



Explosion Hazard! Improper jumper cable connections can cause an explosion resulting in serious injury or death. Batteries may be located in separate compartments. When using jump start cables, always connect the positive (+) cable from the source to the positive (+) terminal of the battery that is connected to the starter solenoid. Connect the negative (-) cable from the source to the negative (-) terminal of the starter. If the machine is not equipped with a starter negative terminal, connect the negative (-) cable to the engine block. Follow the procedure in the Operation and Maintenance Manual.

Refer to Operation and Maintenance Manual, "Engine Starting with Jump Start Cables" for further information.

Product: BACKHOE LOADER
Model: 424B HD BACKHOE LOADER JRY
Configuration: 424B HD Backhoe Loader JRY00001-UP (MACHINE)

Operation and Maintenance Manual 424B HD Backhoe Loader

Media Number -SEBU9921-04

Publication Date -01/01/2015

Date Updated -11/10/2018

i04923817

General Hazard Information

SMCS - 7000



Illustration 1

g03090918

Attach a “Do Not Operate” warning tag or a similar warning tag to the start switch or to the controls before you service the equipment or before you repair the equipment. These warning tags (Special Instruction, SEHS7332) are available from your Cat dealer.

Know the width of your equipment in order to maintain proper clearance when you operate the equipment near fences or near boundary obstacles.

Be aware of high voltage power lines and power cables that are buried. If the machine comes in contact with these hazards, serious injury or death may occur from electrocution.



Illustration 2

g03090920

Wear a hard hat, protective glasses, and other protective equipment, as required.

Do not wear loose clothing or jewelry that can snag on controls or on other parts of the equipment.

Make sure that all protective guards and all covers are secured in place on the equipment.

Keep the equipment free from foreign material. Remove debris, oil, tools, and other items from the deck, from walkways, and from steps.

Secure all loose items such as lunch boxes, tools, and other items that are not a part of the equipment.

Know the appropriate work site hand signals and the personnel that are authorized to give the hand signals. Accept hand signals from one person only.

Do not smoke when you service an air conditioner. Also, do not smoke if refrigerant gas may be present. Inhaling the fumes that are released from a flame that contacts air conditioner refrigerant can cause bodily harm or death. Inhaling gas from air conditioner refrigerant through a lighted cigarette can cause bodily harm or death.

Never put maintenance fluids into glass containers. Drain all liquids into a suitable container.

Obey all local regulations for the disposal of liquids.

Use all cleaning solutions with care. Report all necessary repairs.

Do not allow unauthorized personnel on the equipment.

Unless you are instructed otherwise, perform maintenance with the equipment in the servicing position. Refer to Operation and Maintenance Manual for the procedure for placing the equipment in the servicing position.

Pressure Air and Water

Pressurized air and/or water can cause debris and/or hot water to be blown out. This could result in personal injury.

When pressure air and/or pressure water is used for cleaning, wear protective clothing, protective shoes, and eye protection. Eye protection includes goggles or a protective face shield.

The maximum air pressure for cleaning purposes must be below 205 kPa (30 psi). The maximum water pressure for cleaning purposes must be below 275 kPa (40 psi).

Trapped Pressure

Pressure can be trapped in a hydraulic system. Releasing trapped pressure can cause sudden machine movement or attachment movement. Use caution if you disconnect hydraulic lines or fittings. High-pressure oil that is released can cause a hose to whip. High-pressure oil that is released can cause oil to spray. Fluid penetration can cause serious injury and possible death.

Fluid Penetration

Pressure can be trapped in the hydraulic circuit long after the engine has been stopped. The pressure can cause hydraulic fluid or items such as pipe plugs to escape rapidly if the pressure is not relieved correctly.

Do not remove any hydraulic components or parts until pressure has been relieved or personal injury may occur. Do not disassemble any hydraulic components or parts until pressure has been relieved or personal injury may occur. Refer to the Service Manual for any procedures that are required to relieve the hydraulic pressure.

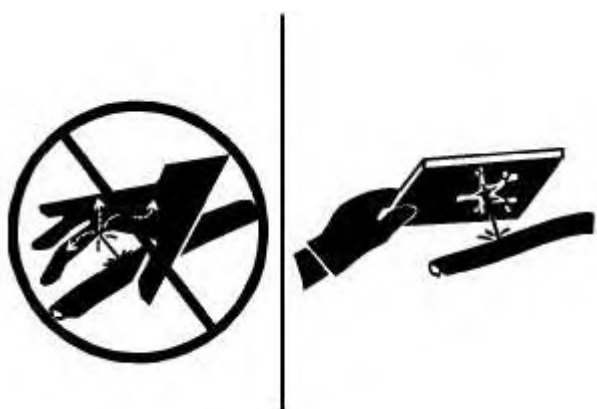

Illustration 3

g03090925

Always use a board or cardboard when you check for a leak. Leaking fluid that is under pressure can penetrate body tissue. Fluid penetration can cause serious injury and possible death. A pin hole leak can cause severe injury. If fluid is injected into your skin, you must get treatment immediately. Seek treatment from a doctor that is familiar with this type of injury.

Containing Fluid Spillage

Care must be taken in order to ensure that fluids are contained during performance of inspection, maintenance, testing, adjusting, and repair of the equipment. Prepare to collect the fluid with suitable containers before opening any compartment or disassembling any component containing fluids.

Refer to Special Publication, NENG2500, "Tools and Shop Products Guide" for the following items:

- Tools that are suitable for collecting fluids and equipment that is suitable for collecting fluids
- Tools that are suitable for containing fluids and equipment that is suitable for containing fluids

Obey all local regulations for the disposal of liquids.



Illustration 4

g03090926

Cat equipment and replacement parts that are shipped from Caterpillar are asbestos free. Caterpillar recommends the use of only genuine Cat replacement parts. Use the following guidelines when you handle any replacement parts that contain asbestos or when you handle asbestos debris.

Use caution. Avoid inhaling dust that might be generated when you handle components that contain asbestos fibers. Inhaling this dust can be hazardous to your health. The components that may contain asbestos fibers are brake pads, brake bands, lining material, clutch plates, and some gaskets. The asbestos that is used in these components is bound in a resin or sealed in some way. Normal handling is not hazardous unless airborne dust that contains asbestos is generated.

If dust that may contain asbestos is present, there are several guidelines that should be followed:

- Never use compressed air for cleaning.
- Avoid brushing materials that contain asbestos.
- Avoid grinding materials that contain asbestos.
- Use a wet method in order to clean up asbestos materials.
- A vacuum cleaner that is equipped with a high efficiency particulate air filter (HEPA) can also be used.
- Use exhaust ventilation on permanent machining jobs.
- Wear an approved respirator if there is no other way to control the dust.

- Comply with applicable rules and regulations for the work place. In the United States, use Occupational Safety and Health Administration (OSHA) requirements. These OSHA requirements can be found in "29 CFR 1910.1001".
- Obey environmental regulations for the disposal of asbestos.
- Stay away from areas that might have asbestos particles in the air.

Dispose of Waste Properly

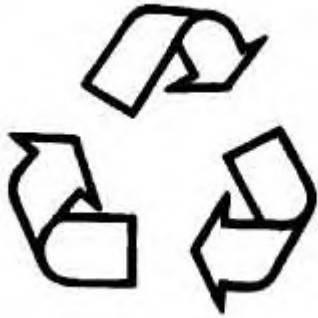

Illustration 5

g03090929

Care must be taken in order to ensure that fluids are contained during performance of inspection, maintenance, testing, adjusting, and repair of the equipment. Prepare to collect the fluid with suitable containers before opening any compartment or disassembling any component containing fluids.

Refer to Special Publication, NENG2500, "Tools and Shop Products Guide" for the following items:

- Tools that are suitable for collecting fluids and equipment that is suitable for collecting fluids.
- Tools that are suitable for containing fluids and equipment that is suitable for containing fluids.

Obey all local regulations for the disposal of liquids.

Product: BACKHOE LOADER
Model: 424B HD BACKHOE LOADER JRY
Configuration: 424B HD Backhoe Loader JRY00001-UP (MACHINE)

Operation and Maintenance Manual 424B HD Backhoe Loader

Media Number -SEBU9921-04

Publication Date -01/01/2015

Date Updated -11/10/2018

i04923821

Crushing Prevention and Cutting Prevention

SMCS - 7000

Support the equipment properly before you perform any work or maintenance beneath that equipment. Do not depend on the hydraulic cylinders to hold up the equipment. Equipment can fall if a control is moved, or if a hydraulic line break.

Do not work beneath the cab of the machine unless the cab is properly supported.

Unless you are instructed otherwise, never attempt adjustments while the machine is moving or while the engine is running.

Never jump across the starter solenoid terminals in order to start the engine. Unexpected machine movement could result.

Whenever there are equipment control linkages the clearance in the linkage area will change with the movement of the equipment or the machine. Stay clear of areas that may have a sudden change in clearance with machine movement or equipment movement.

Stay clear of all rotating and moving parts.

If there is a need to remove guards in order to perform maintenance, always install the guards after the maintenance is performed.

Keep objects away from moving fan blades. The fan blade will throw objects or cut objects.

Do not use a kinked wire cable or a frayed wire cable. Wear gloves when you handle wire cable. When you strike a retainer pin with force, the retainer pin can fly out. The loose retainer pin can injure personnel. Make sure that the area is clear of people when you strike a retainer pin. To avoid injury to your eyes, wear protective glasses when you strike a retainer pin.

Chips or other debris can fly off an object when you strike the object. Make sure that no one can be injured by flying debris before striking any object.

Thank you so much for reading.
Please click the “Buy Now!”
button below to download the
complete manual.



After you pay.

You can download the most
perfect and complete manual in
the world immediately.

Our support email:

ebooklibonline@outlook.com