

Product: EXCAVATOR

Model: E200B EXCAVATOR 6KF

Configuration: E200B, EL200B TRACK-TYPE EXCAVATORS 6KF00001-UP (MACHINE) POWERED BY 3116 ENGINE

Operation and Maintenance Manual E200B AND EL200B TRACK-TYPE EXCAVATORS

Media Number -XEBU9639-02

Publication Date -01/09/1990

Date Updated -30/01/2002

Foreword

SMCS - 7606

This manual contains safety, operation, transportation, lubrication and maintenance information.

Some photographs or illustrations in this publication show details or attachments that may be different from your machine. Guards and covers may have been removed for illustrative purposes.

Continuing improvement and advancement of product design may have caused changes to your machine which are not included in this publication. Read - study - and keep it with the machine.

Whenever a question arises regarding your machine, or this publication, please consult your Caterpillar dealer for the latest available information.

Safety

The safety section lists basic safety precautions. In addition, this section identifies the text and locations of warning labels used on the machine.

Read and understand the basic precautions listed in the safety section before operating or performing lubrication, maintenance and repair on this product.

Operation

The operation section is a reference for the new operator and a refresher for the experienced one. This section includes a discussion of gauges, switches, machine controls, attachment controls, transportation and towing information.

Photographs and illustrations guide the operator through correct procedures of checking, starting, operating and stopping the machine.

Operating techniques outlined in this publication are basic. Skill and techniques develop as the operator gains knowledge of the machine and its capabilities.

Maintenance

The maintenance section is a guide to equipment care. The illustrated, step - by - step instructions are grouped by servicing intervals. Items without specific intervals are listed under "When

Required" topics. Items in the "Maintenance Intervals" chart are referenced to detailed instructions that follow.

Maintenance Intervals

Use the service hour meter to determine servicing intervals. Calendar intervals shown (daily, weekly, monthly, etc.) may be used instead of service hour meter intervals if they provide more convenient servicing schedules and approximate the indicated service hour meter reading.

Recommended service should always be performed at the interval that occurs first.

Under extremely severe, dusty or wet operating conditions, more frequent lubrication than is specified in the "Maintenance Interval" chart may be necessary.

Perform service on items at multiples of the original requirement. For example, at "Every 500 Service Hours or 3 Months", also service those items listed under "Every 250 Service Hours or Monthly", "Every 50 Service Hours or Weekly" and "Every 10 Service Hours or Daily."

Machine Description

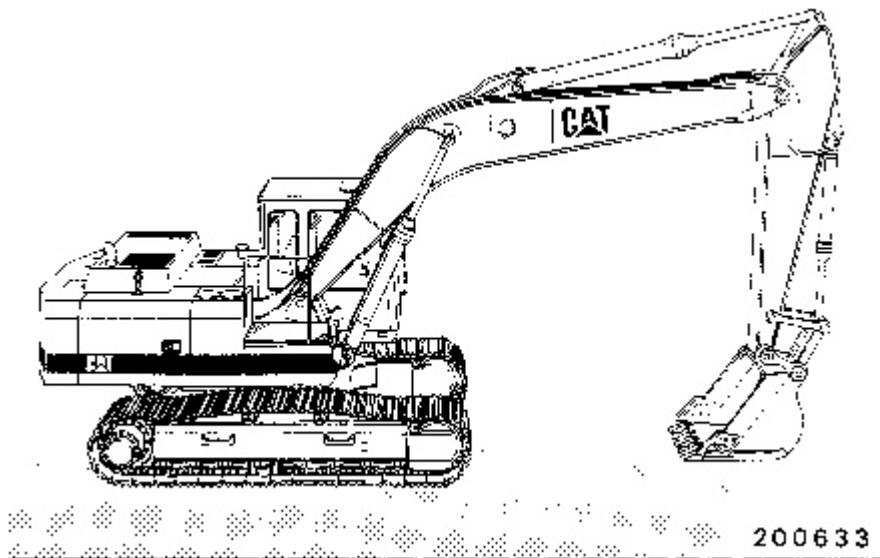

This machine is equipped with a direct injection 3116T turbocharged engine and other specifically developed systems and components such as electronic power unit control system, work mode choice system, 2 - speed travel motor, etc.

Product: EXCAVATOR

Model: E200B EXCAVATOR 6KF

Configuration: E200B, EL200B TRACK-TYPE EXCAVATORS 6KF00001-UP (MACHINE) POWERED BY 3116 ENGINE

Operation and Maintenance Manual E200B AND EL200B TRACK-TYPE EXCAVATORS

Media Number -XEBU9639-02

Publication Date -01/09/1990

Date Updated -30/01/2002

Safety

SMCS - 7606

Warning Signs and Labels

There are several specific safety signs on your machine. Their exact location and description of the hazard are reviewed in this section. Please take the time to familiarize yourself with these safety signs.

Make sure that you can read all safety signs. Clean or replace these if you cannot read the words or see the pictures. When cleaning the labels, use a cloth, water and soap. Do not use solvent, gasoline, etc.

You must replace a label if it is damaged, missing or cannot be read. If a label is on a part that is replaced, make sure a new label is installed on the replaced part. See your Caterpillar dealer for new labels.



Do not operate or work on this machine unless you have read and understand the instructions and warnings in the Operation and Maintenance manual. Failure to follow the instructions or heed the warning could result in injury or death. Contact any Caterpillar dealer for replacement guides. Proper care is your responsibility.

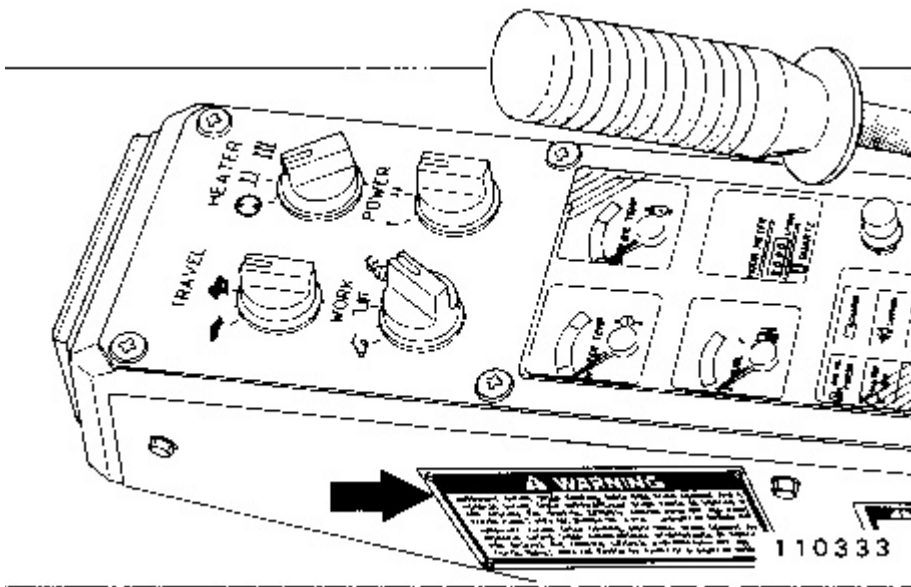

Located in the cab.

⚠ WARNING

Know the maximum height and reach of your machine. Serious injury or death by electrocution can occur if machine or attachments are not kept a safe distance from electrical power lines. Keep distance at least 3 m (10 feet) plus additional 10 mm (0.4 inch) for each 1,000 volts over 50,000 volts.

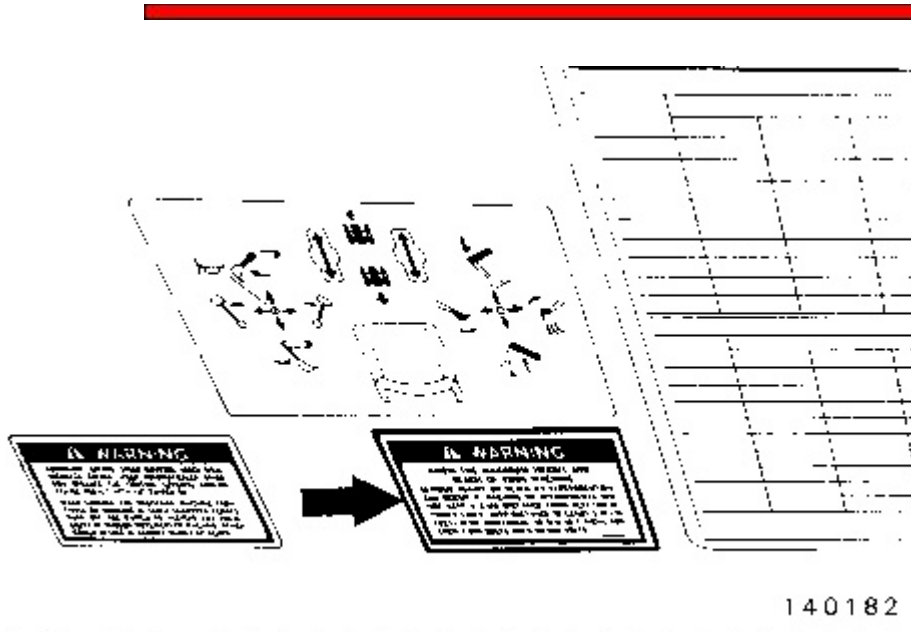

Located in the cab.

⚠ WARNING

Improper jumper cable connections can cause an explosion resulting in personal injury. When using jumper cables always connect positive (+) cable to positive (+) terminal of battery connected to starter solenoid and negative (-) cable from external source to starter negative (-) terminal. (If not equipped with starter negative terminal, connect to engine block.)

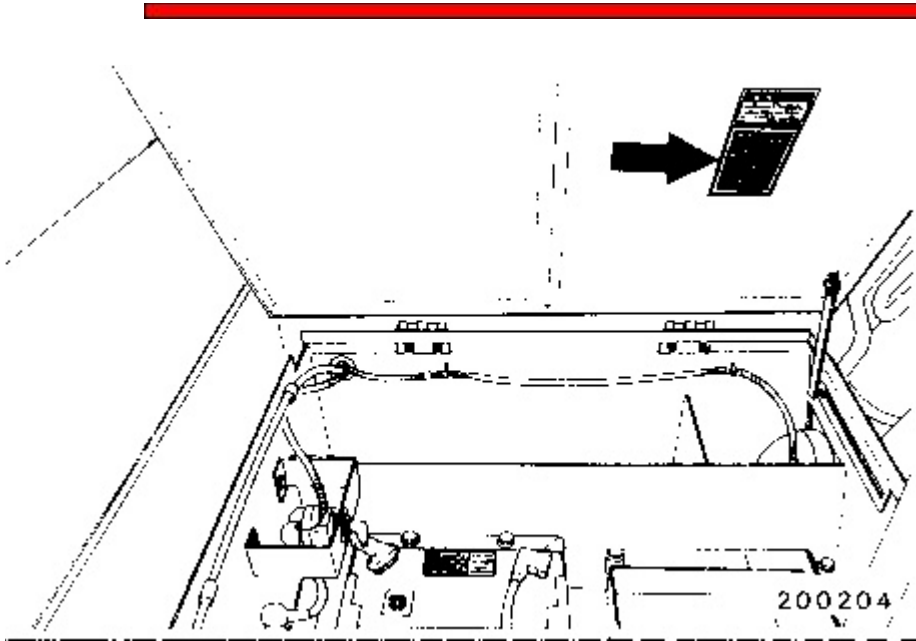

Located on the tool box door.

⚠ WARNING

Relieve tank pressure with engine off by removing cap slowly to prevent burns from hot oil.

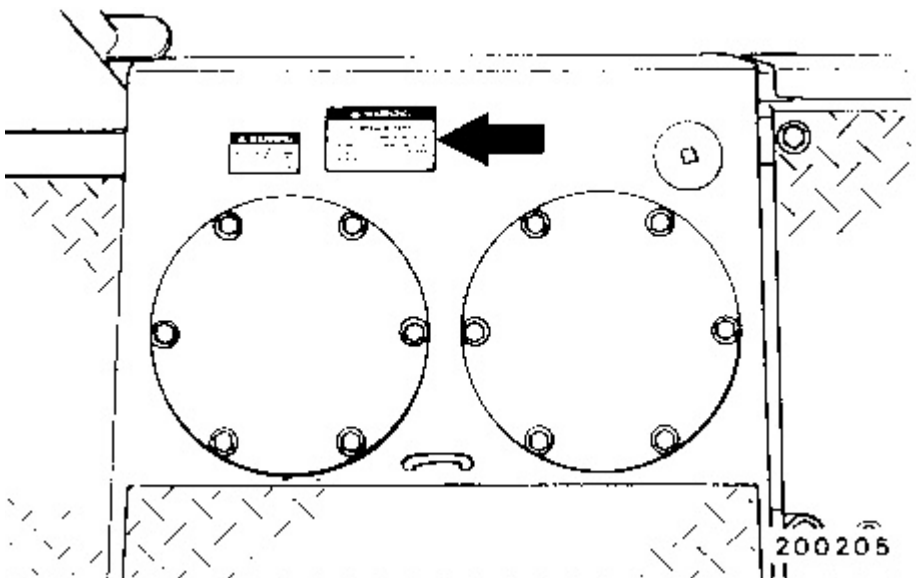

Located on the hydraulic tank.

 **WARNING**

Lift eyes or tank can fail when lifting tank containing fluids resulting in possible personal injury. Drain tank of all fluids before lifting.

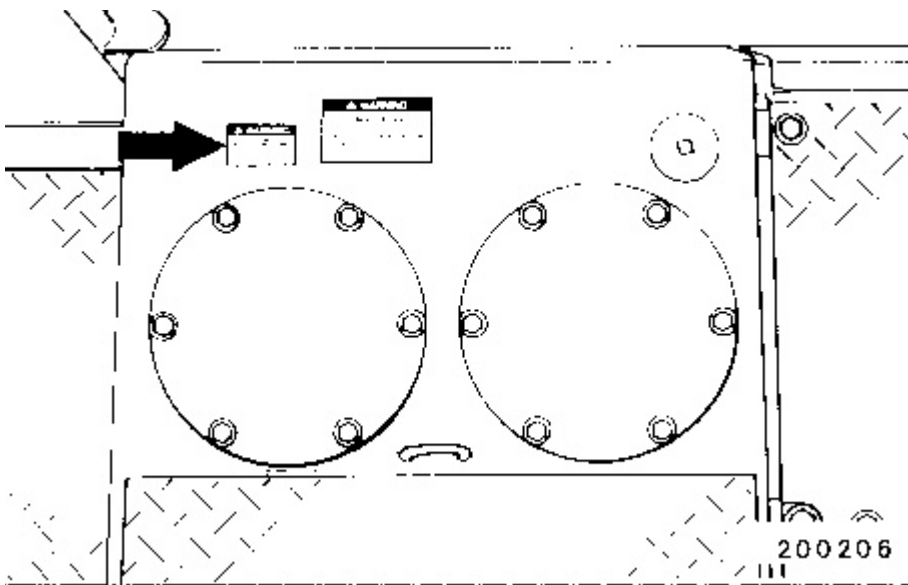

Located on the hydraulic tank.

 **WARNING**

Lift eyes or tank can fail when lifting tank containing fluids resulting in possible personal injury. Drain tank of all fluids before lifting.

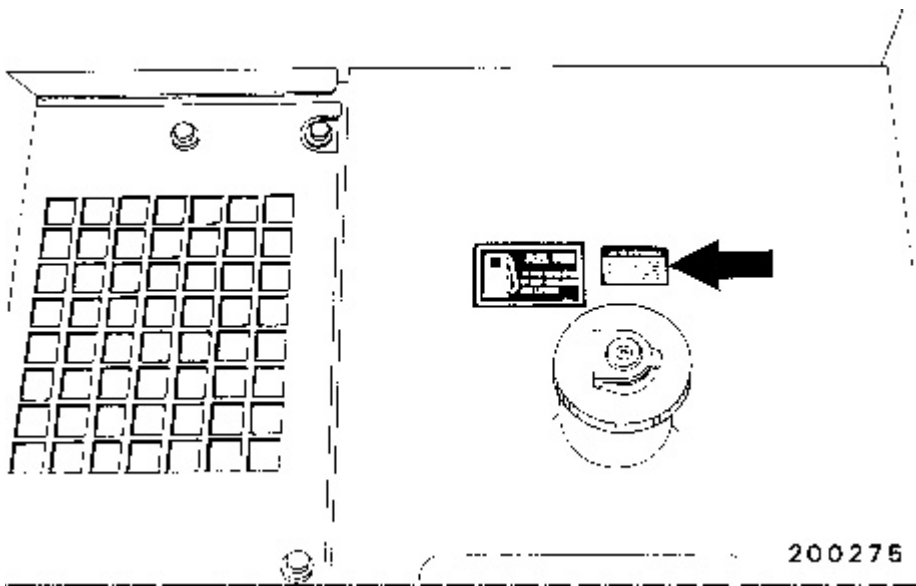

Located on the fuel tank.

 **WARNING**

Do not remove or disassemble any hydraulic components or parts until pressure has been relieved or personal injury may occur.

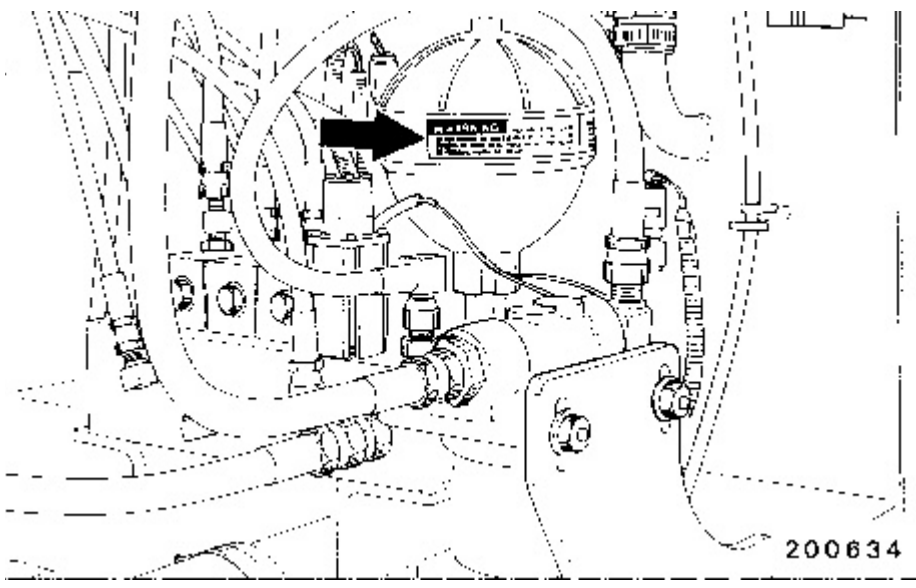

Located on the accumulator.

 **WARNING**

Track Adjuster; Do not remove any parts until all pressure has been relieved to avoid possible personal injury. Relieve pressure by opening relief valve 1 turn maximum.

See Maintenance section for track adjustment procedure.

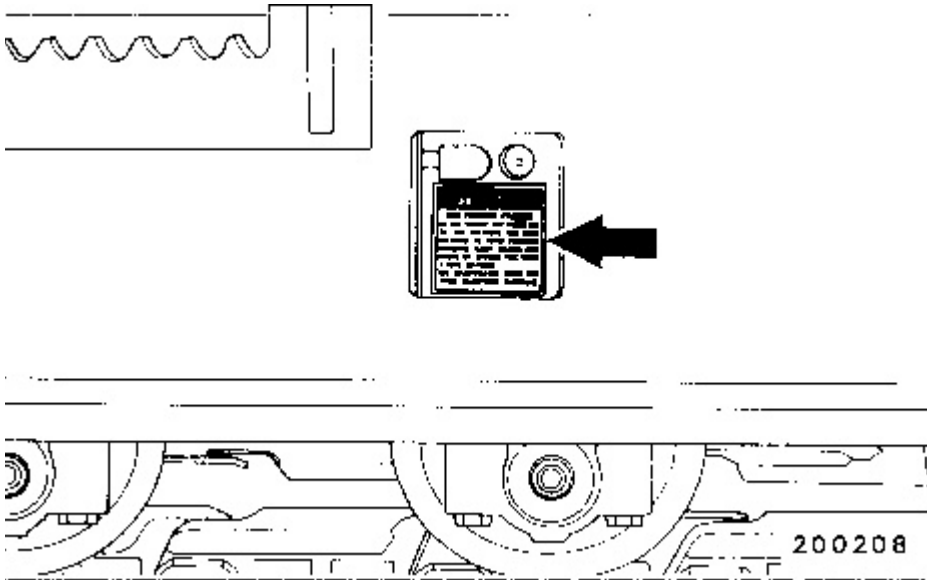

Located on both track frames.



WARNING

Automatic Engine Speed Control (AEC) will increase engine speed automatically when you operate the control lever(s) and/or travel pedals with AEC switch ON.

When loading and unloading machine from truck or working in close quarters always turn off AEC switch to prevent any possibility of sudden movement of machine, which could result in serious injury or death.

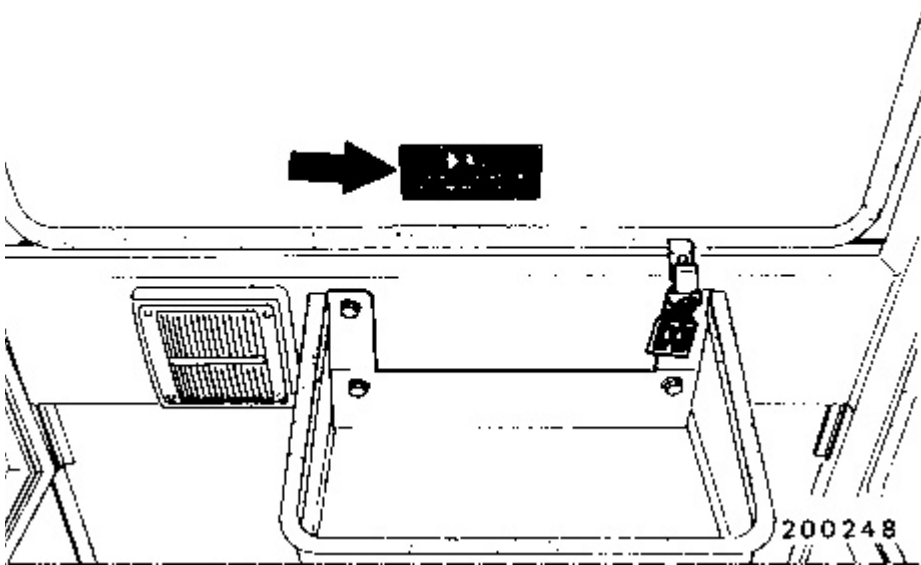

Located above the rear window.

General Hazard Information

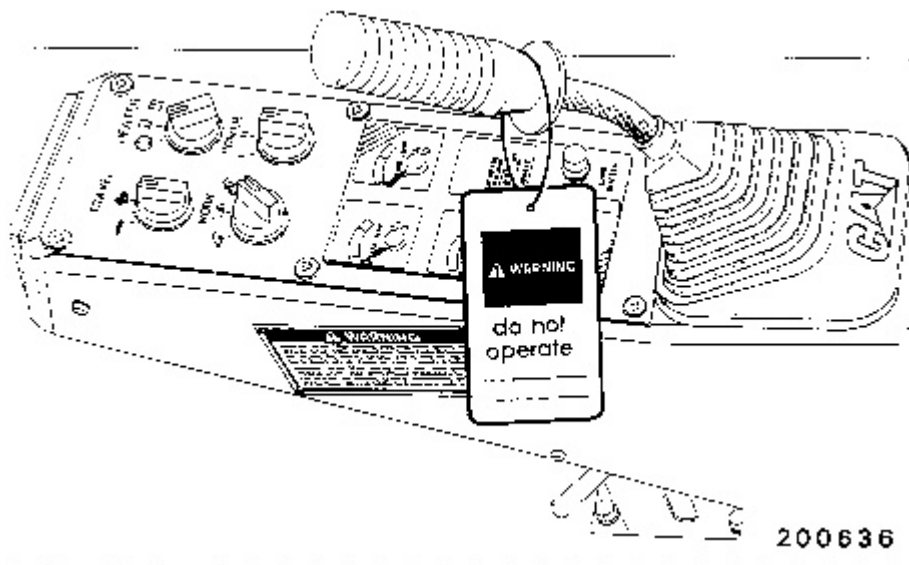

Attach a "DO NOT OPERATE" or similar warning tag to start switch or controls before servicing or repairing the machine. These tags, Form SEHS 7332 are available from your Caterpillar dealer.

Wear a hard hat, protective glasses and other protective equipment as required by job conditions.

Do not wear loose clothing or jewelry that can catch on controls or other parts of the machine.

Make certain all protective guards and covers are secured in place on the machine.

Keep the machine, especially the deck, walkways and steps, free of foreign material, such as debris, oil, tools and other items which are not part of the machine.

Secure all loose items such as lunch boxes, tools and other items which are not part of the machine.

Know the hand signals and who gives them. Accept signals from one person only.

Never put maintenance fluids into glass containers.

Report all needed repairs.

Do not allow unauthorized personnel on the machine.

- * Park the machine on level ground.
- * The attachments lowered to the ground.
- * Move all attachment controls to HOLD.
- * The hydraulic activation control lever in the locked position.
- * Turn the start key switch to the OFF position, to stop the engine.
- * Remove the start switch key.
- * The disconnect switch off and the key removed.

Follow the lift capacity sign in the cab for lifting.

To avoid possible weakening of the FOPS (if equipped), consult a Caterpillar dealer before altering FOPS in any way. The protection offered by this FOPS will be impaired if it has been subjected to structural damage or has been involved in an overturn accident.

The upper structure can swing and cause personal injury during shipping or loading, if the swing lock pin is not engaged.

Lower the clamshell (if equipped) in the open position.

Use the front windshield or rear window as a secondary exit if the door is blocked.

Pressure Air

Pressure air can cause personal injury.

When using pressure air for cleaning, wear a protective face shield, protective clothing and protective shoes.

The maximum air pressure must be less than 205 kPa (30 psi) for cleaning purposes.

Fluid Penetration

Always use a board or cardboard when checking for a leak. Escaping fluid under pressure, even a pin-hole size leak, can penetrate body tissue, causing serious injury, and possible death. If fluid is injected into your skin, it must be removed and treated by a doctor familiar with this type of injury immediately.

Asbestos Information

Caution should be used to avoid breathing dust that may be generated when handling components containing asbestos fibers. If this dust is inhaled, it can be hazardous to your health. Components in Caterpillar products that may contain asbestos fibers are brake pads, brake band and lining assemblies, clutch plates and some gaskets. The asbestos used in these components is usually bound in a resin or sealed in some way. Normal handling is not hazardous as long as airborne dust which contains asbestos is not generated.

If dust which may contain asbestos is present, there are several common sense guidelines that should be followed.

1. Never use compressed air for cleaning.
2. Avoid brushing or grinding of materials containing asbestos.
3. For clean up, use wet methods or a vacuum equipped with a high efficiency particulate air (HEPA) filter.
4. Use exhaust ventilation on permanent machining jobs.
5. Wear an approved respirator if there is no other way to control the dust.
6. Comply with applicable rules and regulations for the work place (for example in the U.S.A., OSHA requirements as set forth in 29 CFR 1910.1001).
7. Follow environmental rules and regulations for disposal of asbestos.
8. Avoid areas where asbestos particles may be in the air.

Crushing or Cutting Prevention

Support equipment and implements properly when working beneath them. Do not depend on hydraulic cylinders to hold implements up. Any implement can fall if a control is moved, or if a hydraulic line breaks.

Never attempt adjustments while the machine is moving or the engine is running unless otherwise specified.

Where there are implement linkages, the clearance in the linkage area will increase or decrease with movement of the implement.

Stay clear of all rotating and moving parts.

Keep objects away from moving fan blades. They will throw or cut any object or tool that falls or is pushed into them.

Do not use a kinked or frayed wire rope cable. Wear gloves when handling the wire rope cable.

Retainer pins, when struck with force, can fly out and injure nearby persons.

Wear protective glasses when striking a retainer pin to avoid injury to your eyes.

Chips or other debris can fly off objects when struck. Make sure no one can be injured by flying debris before striking any object.

Do not attempt to lift the machine with the lift eyes on the cab or counterweight. Consult your Caterpillar dealer for lifting instructions.

Track adjusting grease is under high pressure. Grease coming out of the relief valve under pressure can penetrate the body causing injury or death.

Do not watch the relief valve to see if grease is escaping. Watch the track or track adjustment cylinder to see if the track is being loosened. Loosen the relief valve one turn only.

Burn Prevention

Coolant

At operating temperature, the engine coolant is hot and under pressure. The radiator and all lines to heaters or the engine contain hot water or steam. Any contact can cause severe burns.

Steam can cause personal injury.

Check the coolant level only after the engine has been stopped and the filler cap is cool enough to remove with your bare hand.

Remove the cooling system filler cap slowly to relieve pressure.

Cooling system conditioner contains alkali that can cause personal injury. Avoid contact with the skin and eyes and do not drink.

Allow cooling system components to cool before draining.

Oils



Hot oil and components can cause personal injury. Do not allow hot oil or components to contact the skin.

At operating temperature, the hydraulic tank is hot and can be under pressure.

Remove the hydraulic tank filler cap only after the engine has been stopped and the filler cap is cool enough to remove with your bare hand.

Remove the hydraulic tank cap slowly to relieve pressure.

Relieve all pressure in air, oil, fuel or cooling systems before any lines, fittings or related items are disconnected or removed.

Batteries

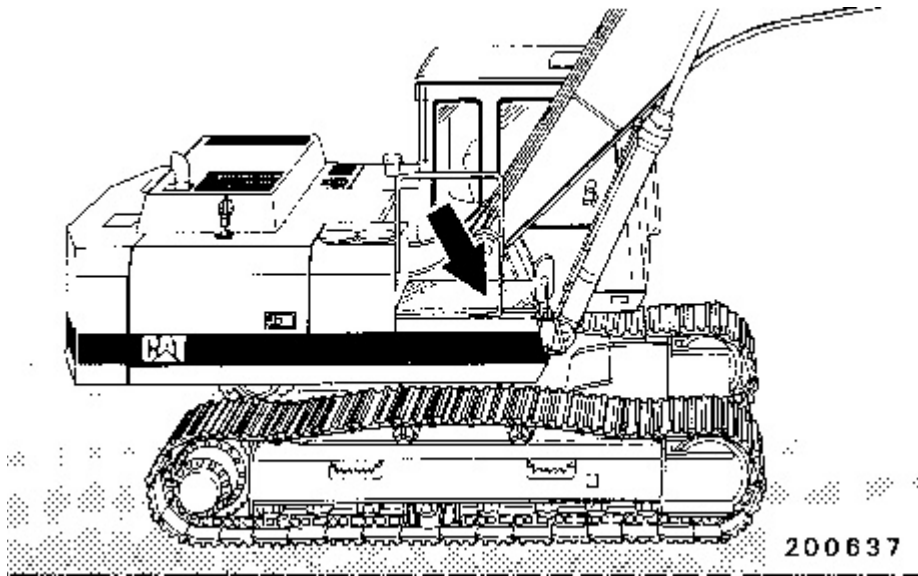

Batteries give off flammable fumes which can explode. Do not smoke when observing the battery electrolyte levels. Electrolyte is an acid and can cause personal injury if it contacts skin or eyes.

Always wear protective glasses when working with batteries.

Fire or Explosion Prevention

All fuels, most lubricants and some coolant mixtures are flammable.

Fuel leaked or spilled onto hot surfaces or electrical components can cause a fire.

Do not smoke while refueling or in a refueling area.

Do not smoke in areas where batteries are charged, or where flammable materials are stored.

Batteries in series may be located in separate compartments. When using jumper cables always connect positive (+) cable to positive (+) terminal of battery connected to starter solenoid and negative (-) cable from external source to starter negative (-) terminal. (If not equipped with starter negative terminal, connect to engine block.)

See the "Operation Section" of the manual for specific instructions.

Clean and tighten all electrical connections. Check daily for loose or frayed electrical wires. Have all loose or frayed electrical wires tightened, repaired or replaced before operating the machine.

Keep all fuels and lubricants stored in properly marked containers and away from all unauthorized persons.

Store all oily rags or other flammable material in a protective container, in a safe place.

Do not weld or flame cut on pipes or tubes that contain flammable fluids. Clean them thoroughly with nonflammable solvent before welding or flame cutting on them.

Remove all flammable materials such as fuel, oil and other debris before they accumulate on the machine.

Do not expose the machine to flames, burning brush, etc., if at all possible.

Shields, which protect hot exhaust components from oil or fuel spray in the event of a line, tube or seal failure, must be installed correctly.

Have a fire extinguisher available and know how to use it. Inspect and have it serviced as recommended on its instruction plate.

Ether

Read and follow ether manufacture's instruction, when using ether to start a machine.

Ether is poisonous and flammable.

Breathing ether vapors or repeated contact of ether with skin can cause personal injury.

Use ether only in well ventilated areas.

Do not smoke while changing ether cylinders.

Use ether with care to avoid fires.

Do not store replacement ether cylinders in living areas or in the operator's compartment.

Do not store ether cylinders in direct sunlight or at temperatures above 39 °C (102 °F).

Discard cylinders in a safe place. Do not puncture or burn cylinders.

Keep ether cylinders out of the reach of unauthorized personnel.

Lines, Tubes and Hoses

Do not bend or strike high pressure lines. Do not install bent or damaged lines, tubes or hoses.

Repair any loose or damaged fuel and oil lines, tubes and hoses. Leaks can cause fires. Contact your Caterpillar dealer for repair or replacement.

Check lines, tubes and hoses carefully. Do not use your bare hands to check for leaks. Use a board or cardboard to check for leaks. See "Fluid penetration" in the "Safety" section for more details. Tighten all connections to the recommended torque. Replace if any of the following conditions are found:

1. End fittings damaged, or leaking.
2. Outer covering chafed or cut and wire reinforcing exposed.
3. Outer covering ballooning locally.
4. Evidence of kinking or crushing of the flexible part of hose.
5. Armouring embedded in the outer cover.
6. End fittings displaced.

Make sure that all clamps, guards and heat shields are installed correctly to prevent vibration, rubbing against other parts and excessive heat during operation.

Mounting and Dismounting

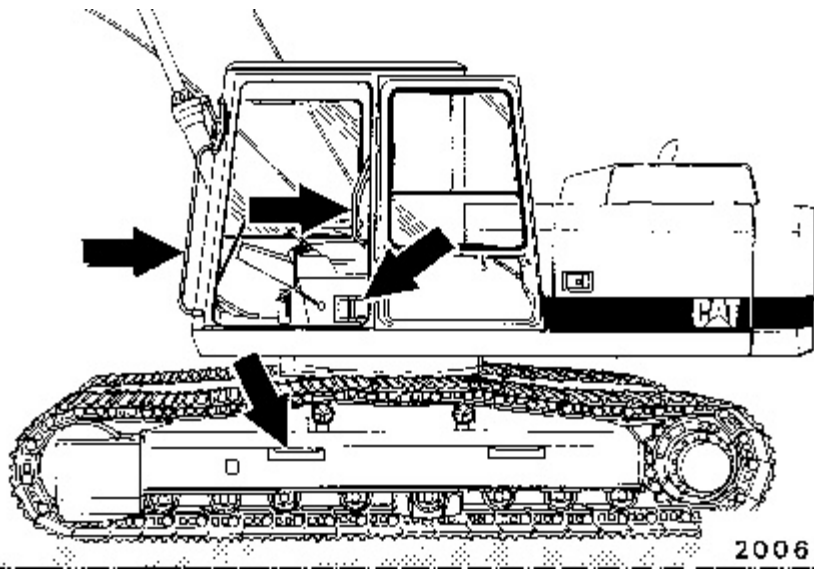

Mount and dismount the machine only where steps and/or handholds are provided.

Use both hands and face the machine, when mounting and dismounting.

Never get on or off a moving machine. Never jump off the machine.

Do not try to climb on or off the machine when carrying tools or supplies. Use a hand line to pull equipment up onto the platform.

Before Starting the Engine

Start the engine only from the operator's station. Never short across the starter terminals or across the batteries, as this could bypass the engine neutral-start system as well as damage the electrical system.

Inspect the condition of the seat belt and mounting hardware. Replace any damaged or worn parts. Replace the seat belt regardless of appearance after three years of use.

Adjust the seat so that full pedal travel can be obtained with the operator's back against the seat back.

Make sure the machine is equipped with a lighting system as required by conditions. Make sure all lights are working properly.

Make sure no one is working on, underneath or close to the machine before starting the engine or beginning to move the machine. Make sure the area is free of personnel.

Engine Starting

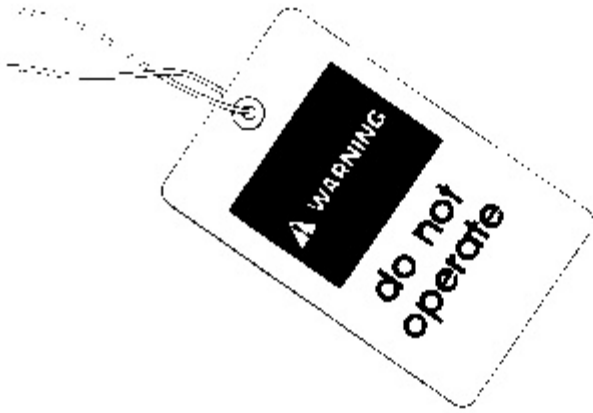

200430

Do not start the engine or move any of the controls if there is a "DO NOT OPERATE" or similar warning tag attached to the start switch or controls.

Move all hydraulic controls to the HOLD position before starting the engine.

Start and operate the engine in a well ventilated area only. In an enclosed area, vent the exhaust to the outside.

Before Operating the Machine

Clear all personnel from the machine and the area.

Clear all obstacles from the path of the machine. Beware of hazards such as wires, ditches, etc.

Be sure all windows are clean. Secure the doors and windows in either the open or shut position.

Adjust the rear view mirrors (if equipped) for best vision, especially close to the machine.

Make sure the machine horn, the travel alarm (if equipped) and all other warning devices are working properly.

Before moving the machine, check the position of the undercarriage. The normal travel position is with the idler wheels to the front under the cab and the drive sprockets to the rear. When the undercarriage is in the reversed position, the directional controls must be operated in reverse.

Fasten the seat belt securely.

Warm up the engine and the hydraulic oil before operating the machine.

Check for proper operation of all controls and protective devices while moving slowly in an open area.

Operate the machine only while seated.

Machine Operation

Operate the machine only while seated. Operate the controls only with the engine running to prevent uncontrolled implement movement.

Watch boom clearances when moving the machine. Uneven ground can cause the boom to move from side to side or up and down.

The operator must be satisfied that no one will be endangered before moving the machine.

Do not allow riders on the machine unless additional seat, seat belt and Falling Object Protective Structure (FOPS) are provided.

Report any needed repairs noted during operation.

Carry attachments close to the ground, approximately 40 cm (16 in) above ground level.

Stay a safe distance from the edge of cliffs, overhangs and slide areas.

If the machine begins to sideslip on a grade, immediately dispose of the load and turn the machine downhill.

Be careful to avoid the condition which could lead to tipping when working on hills, banks or slopes, and when crossing ditches, ridges or other obstructions.

Work up and down slopes, rather than sideways, whenever possible.

Keep the machine under control and do not work it over its capacity.

Avoid changing the direction of travel on a slope, which could result in tipping or side slipping of the machine.

Bring the load close to the machine before traveling or swinging the load.

Lifting capacity decreases as the load is moved further from the machine.

Be sure hitch points and the towing device are adequate.

Connect trailing equipment to a drawbar or hitch only.

Never straddle a wire rope cable or similar device, nor allow others to do so.

No personnel should be between the machine and trailing equipment when maneuvering to connect them. Block the tongue or hitch of trailing equipment to align it with the drawbar or hitch.

For safety, local or state codes or job site operating directives may require a greater distance from obstacles.

Do not attempt to engage the swing lock pin while the swing frame is rotating.

Check with the local utilities for the locations of buried pipes and cables before operating the machine.

Know the maximum height and reach of your machine.

Keep eye contact with the load at all times.

Always keep the Falling Object Protective Structure (FOPS) (if equipped) installed when operating the machine.

The clamshell can swing in all directions. Use hydraulic controls smoothly to avoid excessive clamshell swing. Failure to do so could cause the clamshell to swing into the cab or into a person in the work area, resulting in personal injury.

Machine Parking

The hydraulic implement and machine controls are "live" even if the engine is not running.

Sudden and unexpected machine and/or implement movement will occur if any of the controls are moved. This can cause personal injury or death.

Always move the hydraulic and directional lock lever to the LOCKED position before shutting off the engine or immediately after the engine quits running.

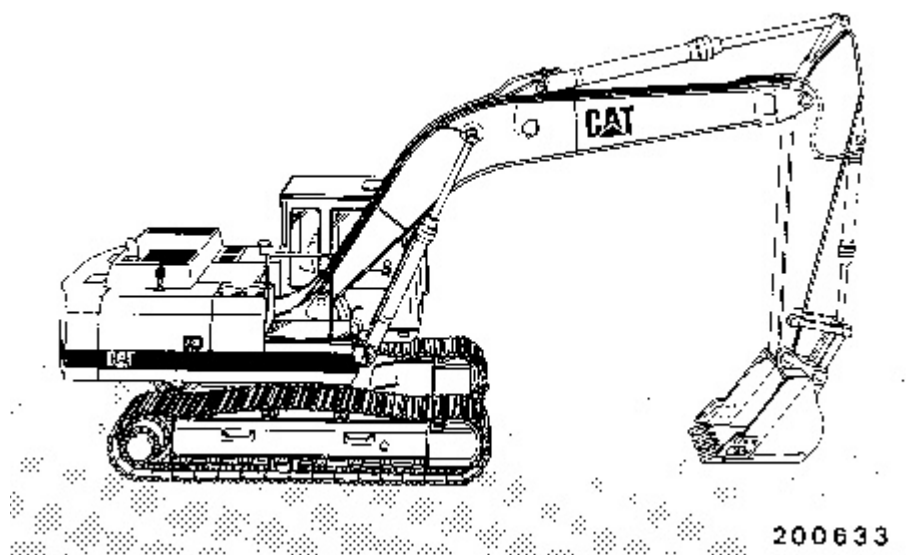

Park on a level surface. If necessary to park on a grade, block the machine.

Place the implements in the servicing position. (See illustration above.)

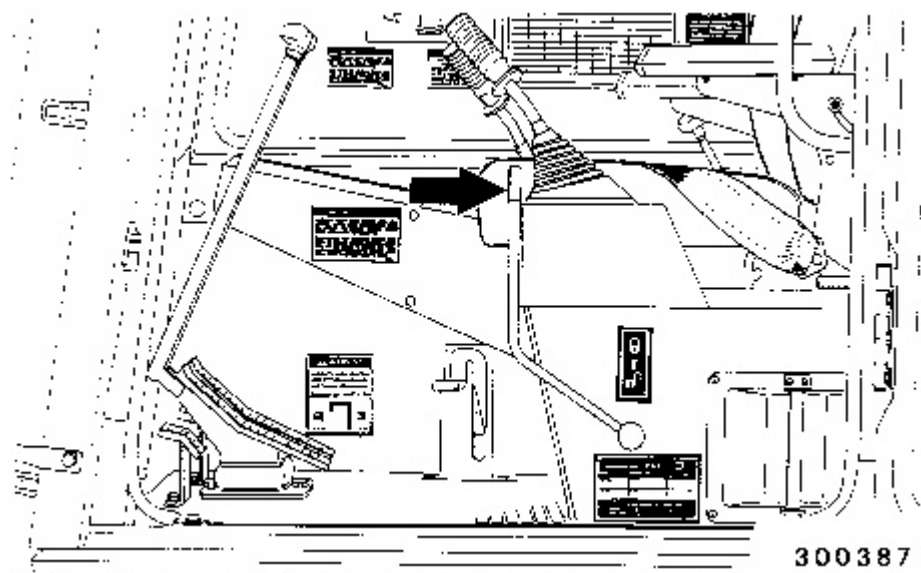

Move the hydraulic activation control lever to the locked position.

Turn the start key switch to the OFF position to stop the engine.

Remove the start switch key and the disconnect switch key.

Thank you so much for reading.
Please click the “Buy Now!”
button below to download the
complete manual.



After you pay.

You can download the most
perfect and complete manual in
the world immediately.

Our support email:

ebooklibonline@outlook.com