

Product: EXCAVATOR

Model: EL180 EXCAVATOR 4EF

Configuration: E180 EL180 HYDRAULIC EXCAVATORS 4EF00001-UP (MACHINE) POWERED BY 3204 ENGINE

Operation and Maintenance Manual E180 AND EL180 HYDRAULIC EXCAVATORS

Media Number -XEBU9537-01

Publication Date -01/04/1987

Date Updated -30/01/2002

Foreword

SMCS - 7606

This guide contains operation instructions and lubrication and maintenance information.

The operation section is a reference for the new operator and a refresher for the experienced one. Read - study - and keep it handy.

Illustrations guide the operator through correct procedures of checking, starting, operating and stopping the machine.

Operating techniques outlined in this publication are basic. Skill and techniques develop as the operator gains knowledge of the machine and its capabilities.

The maintenance section is a guide to equipment care. The illustrated, step-by-step instructions are grouped by servicing intervals. Items without specific intervals are listed under "When Required." Items in the "Lubrication and Maintenance Interval Chart" are referenced to detailed instructions that follow.

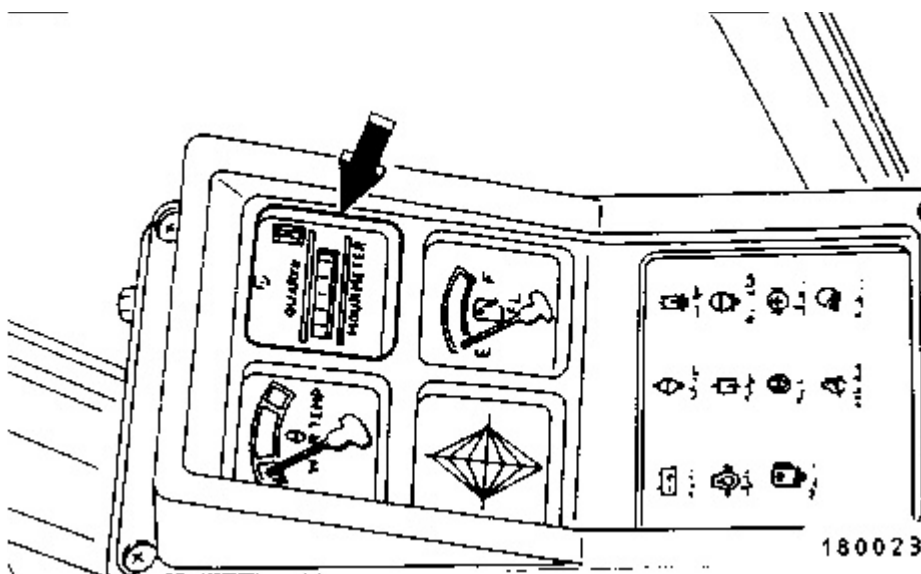

Use the service hour meter to determine servicing intervals. Calendar intervals shown (daily, weekly, monthly, etc.) may be used instead of service hour meter intervals if they provide more convenient servicing schedules and approximate the indicated service hour meter reading. Recommended service should always be performed at the interval that occurs first.

Under extremely severe, dusty or wet operating conditions, more frequent lubrication than is specified in the "Lubrication and Maintenance Interval Chart" may be necessary.

Perform service on items at multiples of the original requirement. For example, at Every 500 Service Hours or 6 Months, also service those items listed under Every 250 Service Hours or 3 Months, Every 100 Service Hours or Monthly and Every 10 Service Hours or Daily.

Some illustrations in this publication show details or attachments that may be different from your machine. Also, guards and covers may have been removed for illustrative purposes.

Continuing improvement and advancement of product design may have caused changes to your machine which are not included in this publication.

Whenever a question arises regarding your machine, or this publication, please consult your Caterpillar dealer for the latest available information.

Product: EXCAVATOR

Model: EL180 EXCAVATOR 4EF

Configuration: E180 EL180 HYDRAULIC EXCAVATORS 4EF00001-UP (MACHINE) POWERED BY 3204 ENGINE

Operation and Maintenance Manual E180 AND EL180 HYDRAULIC EXCAVATORS

Media Number -XEBU9537-01

Publication Date -01/04/1987

Date Updated -30/01/2002

Safety

SMCS - 7606

Warning Signs and Labels

There are several specific safety signs on your machine. Their exact location and description of the hazard are reviewed in this section. Please take the time to familiarize yourself with these safety signs.

Make sure that you can read all safety signs. Clean or replace these if you cannot read the words or see the pictures. When cleaning the labels use a cloth, water and soap. Do not use solvent, gasoline, etc.

You must replace a label if it is damaged, missing or cannot be read. If a label is on a part that is replaced, make sure a new label is installed on the replaced part. See your Caterpillar dealer for new labels.



Do not operate or work on this machine unless you have read and understand the instructions and warnings in the Operation and Maintenance guide. Failure to follow the instructions or heed the warnings could result in injury or death. Contact any Caterpillar dealer for replacement guides. Proper care is your responsibility.

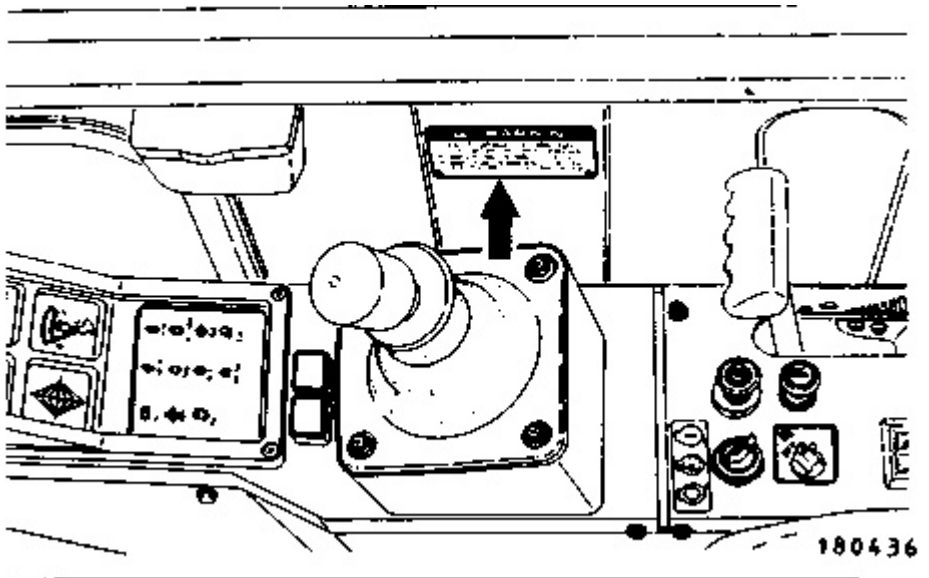

Located in the Cab.

 **WARNING**

Know the maximum height and reach of your machine. Serious injury or death by electrocution can occur if machine or attachments are not kept a safe distance from electrical power lines. Keep distance at least 3 m (10 feet) plus additional 10 mm (0.4 inch) for each 1,000 volts over 50,000 volts.

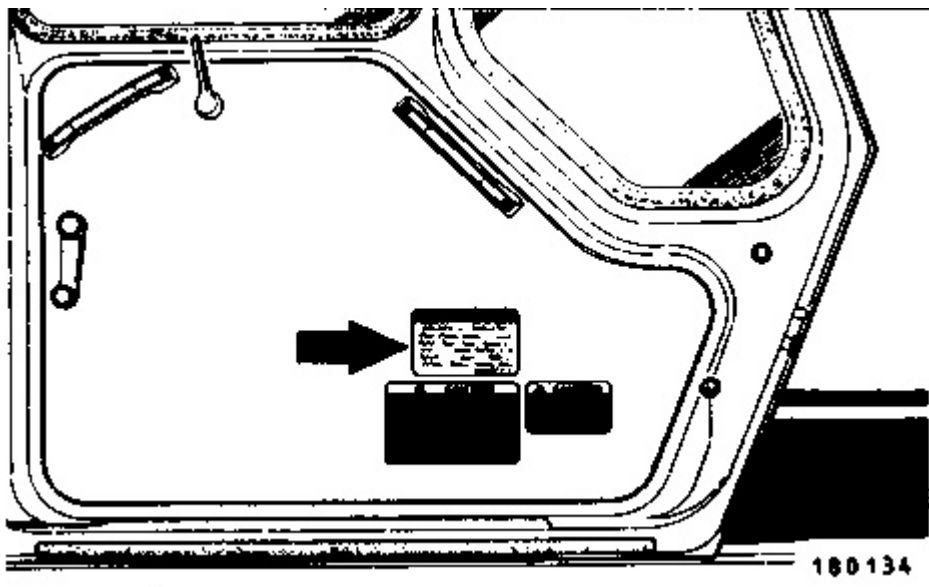

Located on the cab door.

 **WARNING**

Improper jumper cable connections can cause an explosion resulting in personal injury. When using jumper cables always connect positive (+) cable to positive (+) terminal of battery connected to starter solenoid and negative (-) cable from external source to starter negative (-) terminal. (If not equipped with starter negative terminal, connect to engine block.)

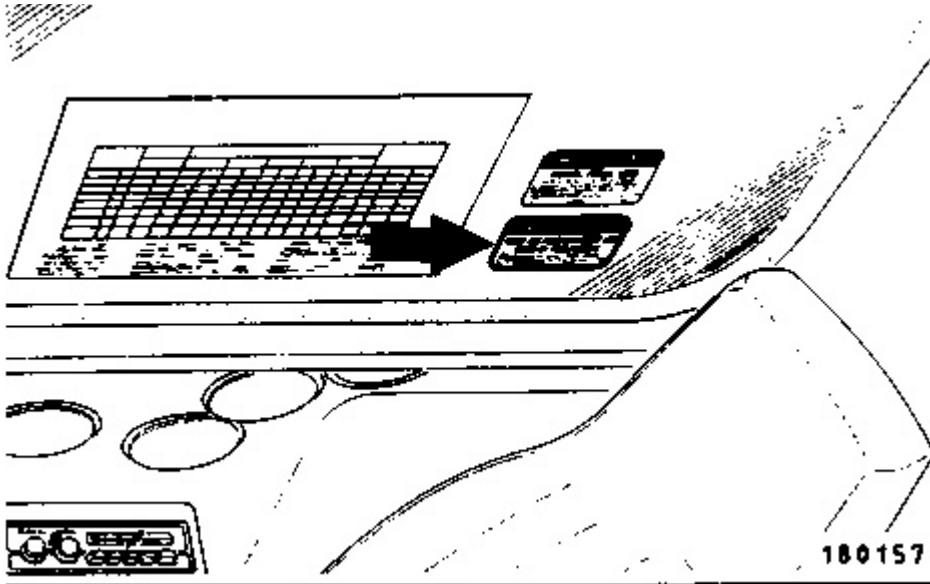

Located in the cab.

Poison/Danger Causes Severe Burns

Contains sulfuric acid. Avoid contact with skin, eyes or clothing. Antidote: EXTERNAL - Flush with water. INTERNAL - Drink large quantities water or milk. Follow with milk of magnesia, beaten egg or vegetable oil. Call physician immediately. Eyes: Flush with water for 15 minutes and get prompt medical attention. Batteries produce explosive gases. Keep sparks, flame, cigarettes away. Ventilate when charging or using in enclosed space. Always shield eyes when working near batteries.

Keep Out Of Reach Of Children

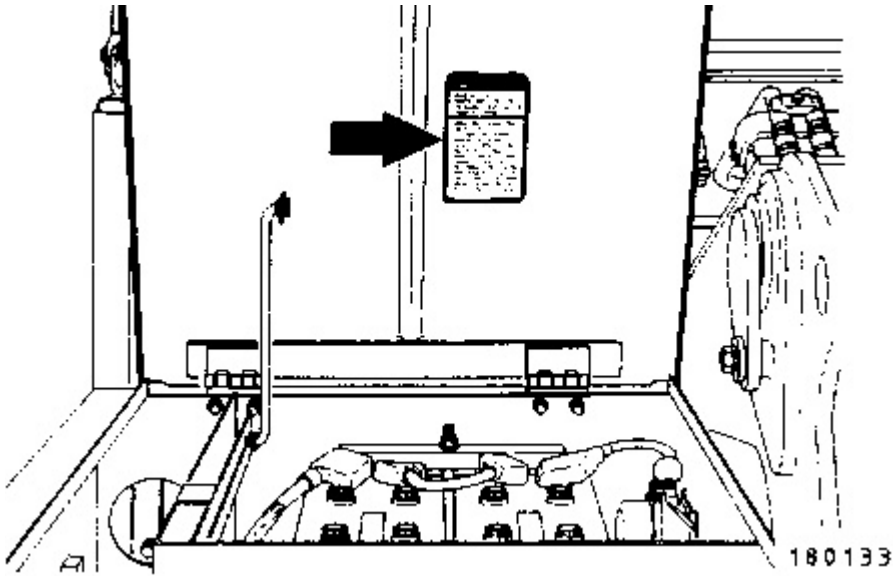

Located on the tool box door.

 **WARNING**

HYDRAULIC TANK

Relieve tank pressure with engine off by removing cap slowly to prevent burns from hot oil.

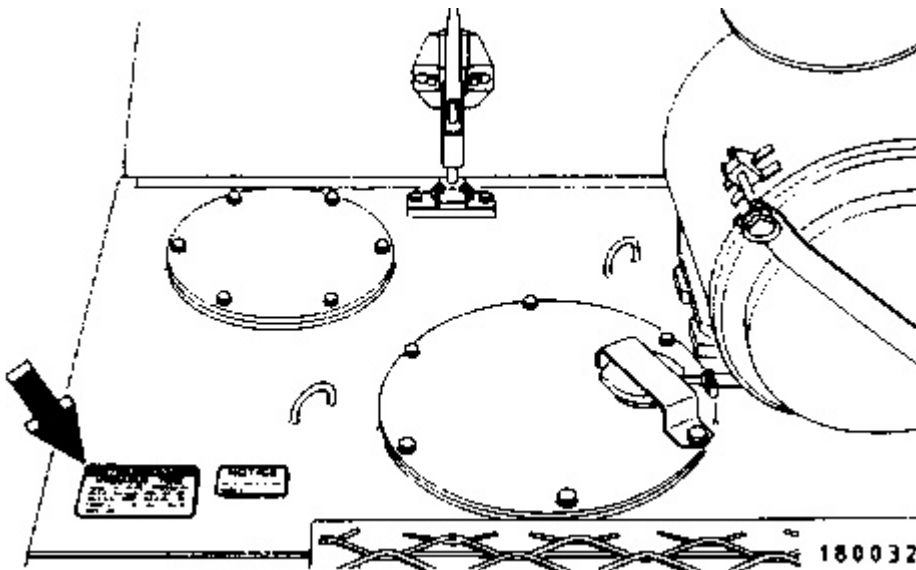

Located on the hydraulic tank.

 **WARNING**

HIGH PRESSURE CYLINDER

Do not remove any parts until all pressure has been relieved to avoid possible personal injury. Relieve pressure by opening relief valve 1 turn maximum.

See Maintenance Section for track adjustment procedure.

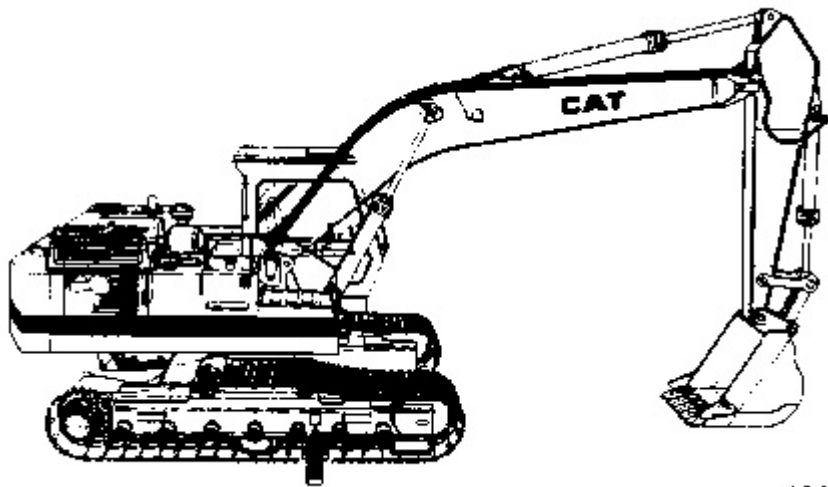

180115

Located on the roller frame.



TRAVEL LEVERS AND PEDAL LOCK

Travel lock must be engaged whenever machine is stopped. If lock is not engaged, the machine could move unexpectedly when the travel levers or pedals are accidentally contacted resulting in possible personal injury.

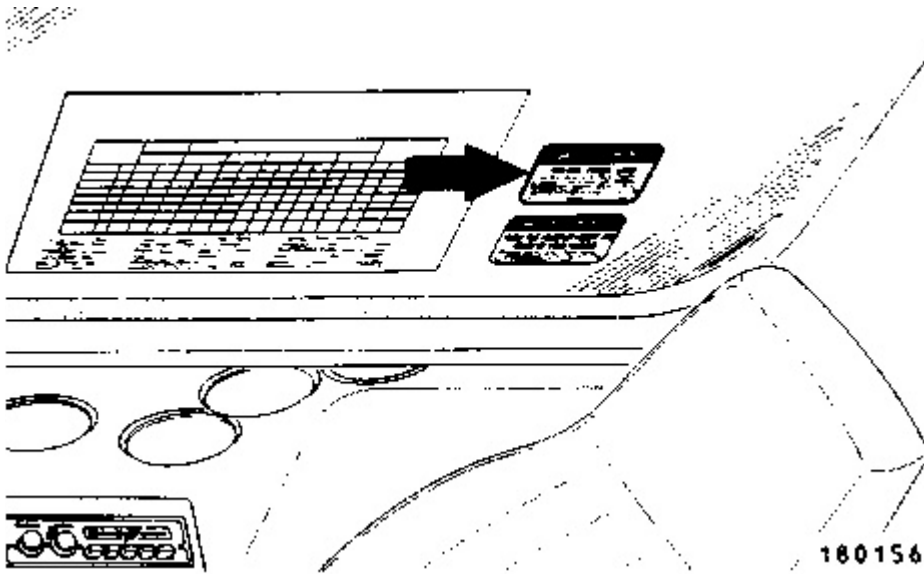

Located in the cab.



SWING LOCK CONTROL

Swing lock must be engaged before shipping machine. If lock is not engaged, upper structure can swing, resulting in possible personal injury.

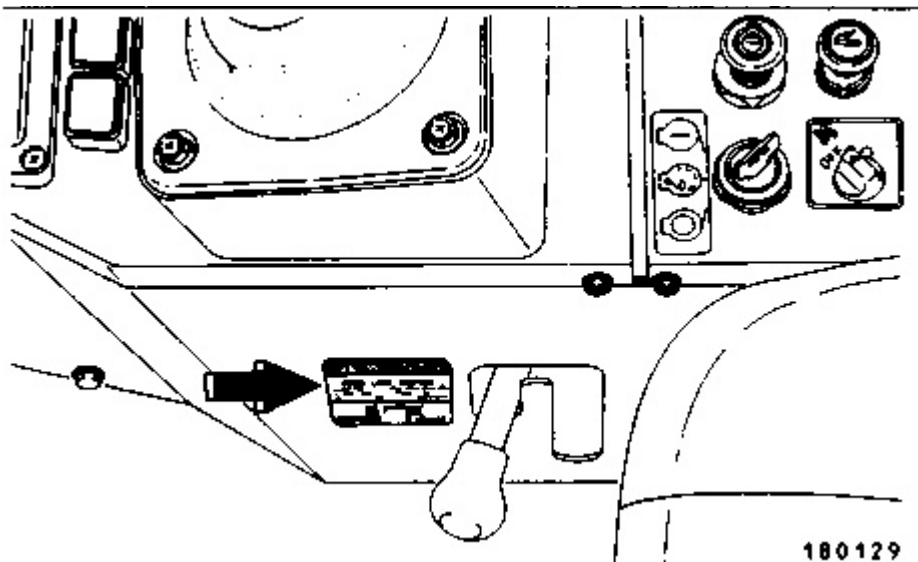

Located in the cab.

General

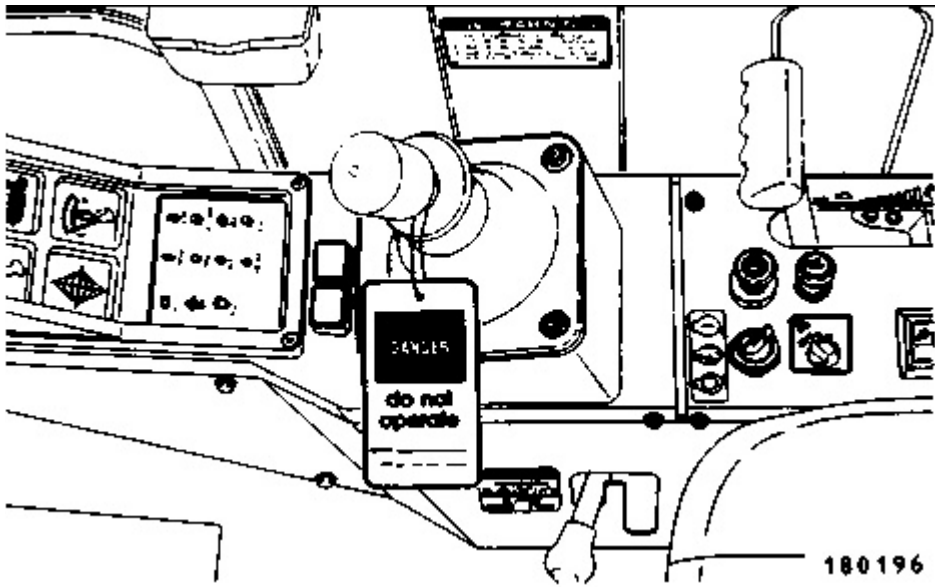

Attach a "DO NOT OPERATE" or similar warning tag to start switch or controls before servicing or repairing the machine. These tags, Form SEHS7332 are available from your Caterpillar dealer.

The "Operation and Maintenance" Guide is in holder located in operator's compartment on seat back. Contact any Caterpillar dealer for a replacement guide. Proper care is your responsibility.

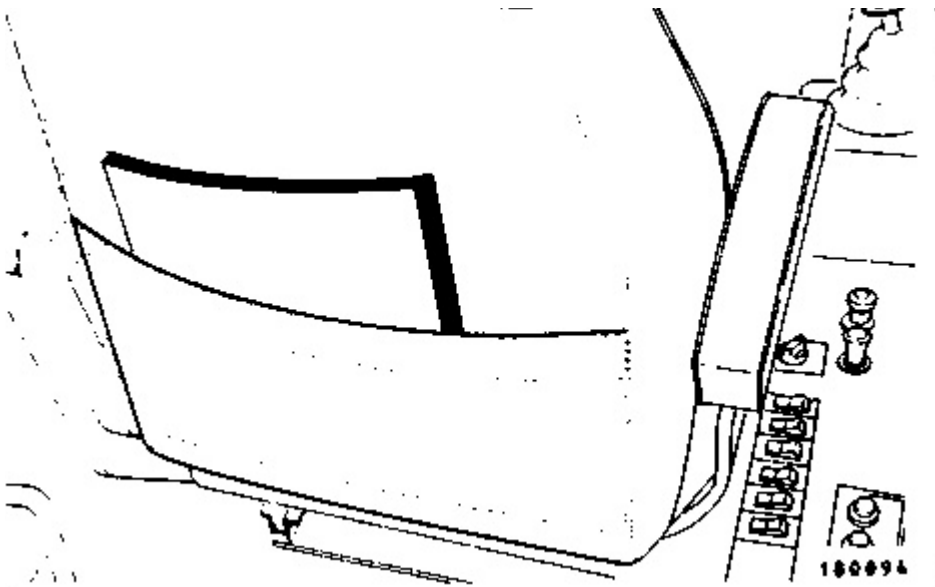

Located on the pocket behind the seat.

Lubrication, maintenance or repair of this machine can be dangerous unless performed properly. Each person must satisfy himself that he has the necessary skill and information, proper tools and equipment, and that his work method is safe and correct. Caterpillar dealers are available to provide service and information.

Perform all maintenance unless otherwise specified as follows:

- The implements lowered to the ground.
- The hydraulic and travel activation levers in the locked position.
- The engine stopped.
- The start switch key off and the key removed.

Follow the lift capacity sign in the cab for lifting.

To avoid possible weakening of the FOPS, consult a Caterpillar dealer before altering FOPS in any way. The protection offered by this FOPS will be impaired if it has been subjected to structural damage or has been involved in an overturn accident.

With the travel lever lock system disconnected, the machine has no brakes. To prevent unexpected machine movement, block the tracks before the travel lever lock and final drive are disconnected.

The upper structure can swing and cause personal injury during shipping or roading, if the swing lock pin is not engaged.

Lower the clamshell (if equipped) in the open position.

Use the front windshield or rear window as a secondary exit if the door is blocked.

Wear a hard hat, protective glasses and other protective equipment as required by job conditions.

Do not wear loose clothing or jewelry that can catch on controls or other parts of the machine.

Make certain all protective guards and covers are secured in place on the machine.

Keep the machine, especially the deck, walkways and steps, free of foreign material, such as debris, oil, tools and other items which are not part of the machine.

Secure all loose items such as lunch boxes, tools and other items which are not part of the machine.

Know the hand signals and who gives them. Accept signals from one person only.

Never put maintenance fluids into glass containers.

Report all needed repairs.

Do not allow unauthorized personnel on the machine.

When using pressure air for cleaning, wear a protective face shield and protective clothing.

Maximum air pressure from the nozzle must be less than 205 kPa (30 psi) for cleaning purposes.

Asbestos Information

Caution should be used to avoid breathing dust that may be generated when handling components containing asbestos fibers. If this dust is inhaled, it can be hazardous to your health. Components in Caterpillar products that may contain asbestos fibers are brake pads, brake band and lining assemblies, clutch plates and some gaskets. The asbestos used in these components is usually bound in a resin or sealed in some way. Normal handling is not hazardous as long as airborne dust which contains asbestos is not generated.

If dust which may contain asbestos is present, there are several common sense guidelines that should be followed.

1. Never use compressed air for cleaning.
2. Avoid brushing or grinding of materials containing asbestos.

3. For clean up, use wet methods or a vacuum equipped with a high efficiency particulate air (HEPA) filter.
4. Use exhaust ventilation on permanent machining jobs.
5. Wear an approved respirator if there is no other way to control the dust.
6. Comply with applicable rules and regulations for the work place (for example in the U.S.A., OSHA requirements as set forth in 29 CFR 1910.1001).
7. Follow environmental rules and regulations for disposal of asbestos.
8. Avoid areas where asbestos particles may be in the air.

Crushing or Cutting Prevention

Never attempt adjustments while the machine is moving or the engine is running unless otherwise specified.

Support equipment and implements properly when working beneath them. Do not depend on hydraulic cylinders to hold implements up. Any implement can fall if a control is moved, or if a hydraulic line breaks.

Where there are implement linkages, the clearance in the linkage area will increase or decrease with movement of the implement.

Stay clear of all rotating and moving parts.

Keep objects away from moving fan blades. They will throw or cut any object or tool that falls or is pushed into them.

Do not use a kinked or frayed wire rope cable. Wear gloves when handling the wire rope cable.

Retainer pins, when struck with force, can fly out and injure nearby persons.

Wear protective glasses when striking a retainer pin to avoid injury to your eyes.

Chips or other debris can fly off objects when struck. Make sure no one can be injured by flying debris before striking any object.

Do not attempt to lift the machine with the lift eyes on the cab. Consult your Caterpillar dealer for lifting instructions.

Burn Prevention

At operating temperature, the engine coolant is hot and under pressure. The radiator and all lines to heaters or the engine contain hot water or steam. Any contact can cause severe burns.

Check the coolant level only after the engine has been stopped and the filler cap is cool enough to remove with your bare hand.

Remove the cooling system filler cap slowly to relieve pressure.

Cooling system conditioner contains alkali that can cause personal injury. Avoid contact with the skin and eyes and do not drink.

Allow cooling system components to cool before draining.

Hot oil and components can cause personal injury. Do not allow hot oil or components to contact the skin.

At operating temperature, the hydraulic tank is hot and can be under pressure.

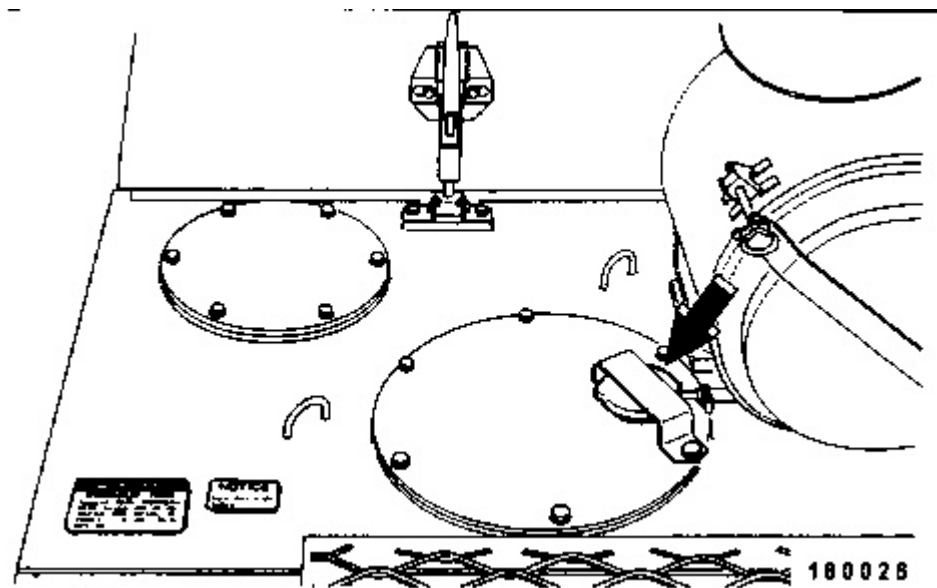

Remove the hydraulic tank filler cap only after the engine has been stopped and the filler cap is cool enough to remove with your bare hand.

Remove the hydraulic tank filler cap slowly to relieve pressure.

Relieve all pressure in air, oil, fuel or cooling systems before any lines, fittings or related items are disconnected or removed.

Battery electrolyte contains acid that can cause injury. Avoid contact with the skin and eyes.

Fire or Explosion Prevention

All fuels, most lubricants and some coolant mixtures are flammable.

Do not smoke while refueling or in a refueling area.

Do not smoke in areas where batteries are charged, or where flammable materials are stored.

Batteries in series may be located in separate compartments.

See the "Starting the Engine Section" in this guide for specific instructions.

Clean and tighten all electrical connections. Check daily for loose or frayed electrical wires. Have all loose or frayed electrical wires tightened, repaired or replaced before operating the machine.

Keep all fuels and lubricants stored in properly marked containers and away from all unauthorized persons.

Store all oily rags or other flammable material in a protective container, in a safe place.

Remove all flammable materials such as fuel, oil and other debris before they accumulate on the machine.

Do not expose the machine to flames, burning brush, etc., if at all possible.

Lines, Tubes and Hoses

Do not bend or strike high pressure lines. Do not install bent or damaged lines, tubes or hoses.

Repair any loose or damaged fuel and oil lines, tubes and hoses. Leaks can cause fires.

Do not weld or flame cut on pipes or tubes that contain flammable fluids. Clean them thoroughly with nonflammable solvent before welding or flame cutting on them.

Inspect all lines, tubes and hoses carefully. Do not use your bare hands to check for leaks. Tighten all connections to the recommended torque. Replace if any of the following conditions are found:

1. End fittings damaged, displaced or leaking.
2. Outer hose covering chafed or cut and wire reinforcing exposed.
3. Outer hose covering ballooning locally.
4. Evidence of kinking or crushing of the flexible part of the hose.
5. Armouring embedded in the outer hose cover.

Make sure that all clamps, guards and heat shields are installed correctly to prevent vibration, rubbing against other parts and excessive heat during operation.

Shields, which protect hot exhaust components from oil or fuel spray in the event of a line, tube or seal failure, must be installed correctly.

Always have a fire extinguisher on the machine and know how to use it. Inspect and have it serviced as recommended on its instruction plate.

Mounting and Dismounting

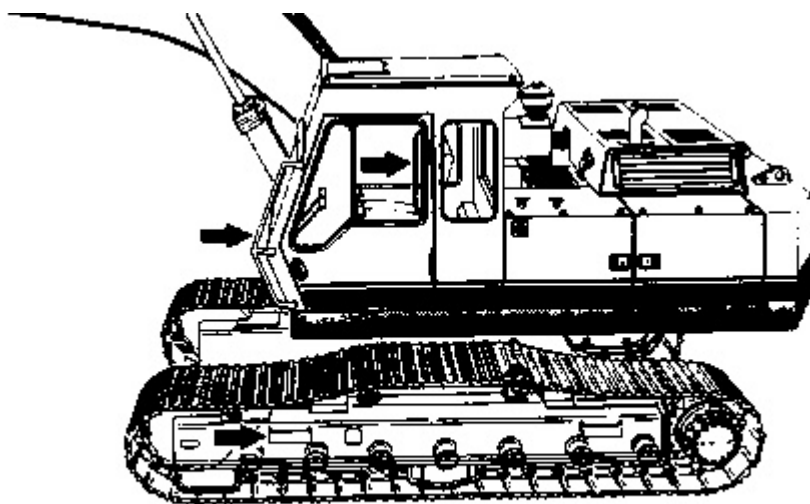

180316

Mount and dismount the machine only where steps and/or handholds are provided.

Use both hands and face the machine, when mounting and dismounting.

Never get on or off a moving machine. Never jump off the machine.

Do not try to climb on or off the machine when carrying tools or supplies. Use a hand line to pull equipment up onto the platform.

Preparing to Start the Engine

Inspect the condition of the seat belt and mounting hardware. Replace any damaged or worn parts. Replace the seat belt regardless of appearance, after three years of use.

Adjust the seat so that full brake pedal travel can be obtained with the operator's back against the seat back.

Make sure the machine is equipped with a lighting system as required by conditions. Make sure all lights are working properly.

Make sure no one is working on, underneath or close to the machine before starting the engine or beginning to move the machine. Make sure the area is free of personnel.

Start the engine only from the operator's station. Never short across the starter terminals or across the batteries, as this could bypass the engine neutral-start system as well as damage the electrical system.

Starting the Engine

Do not start the engine or move any of the controls if there is a "DO NOT OPERATE" or similar warning tag attached to the start switch or controls.

Move all implement controls to the HOLD position before starting the engine.

Start and operate the engine in a well ventilated area only. In an enclosed area, vent the exhaust to the outside.

Preparing to Operate the Machine

Clear all personnel from the machine and the area.

Clear all obstacles from the path of the machine. Beware of hazards such as wires, ditches, etc.

Be sure all windows are clean. Secure the doors and windows in either the open or shut position.

For best vision, especially close to the machine, adjust the rear view mirror.

Make sure the machine horn, the travel alarm (if equipped) and all other warning devices are working properly.

Before moving the machine, check the position of the undercarriage. The normal travel position is with the idler wheels to the front under the cab and the drive sprockets to the rear. When the undercarriage is in the reversed position, the directional controls must be operated in reverse.

Fasten the seat belt securely.

Warm up the engine and the hydraulic oil before operating the machine.

Check for proper operation of all controls and protective devices while moving slowly in an open area.

Operate the machine only while seated.

Operate the controls only with the engine running to prevent uncontrolled implement movement.

Watch boom clearances when moving the machine. Uneven ground can cause the boom to move from side to side or up and down.

Know the maximum height and reach of your machine.

For safety, local or state codes or jobsite operating directives may require a greater distance from obstacles.

Do not attempt to engage the swing lock pin while the swing frame is rotating.

Check with the local utilities for the locations of buried pipes and cables before operating the machine.

Always keep the Falling Object Protective Structure (FOPS) (if equipped) installed when operating the machine.

Personal injury may result if the clamshell swings into the cab or into a person in the work area. The clamshell can swing in all directions.

Do not allow riders on the machine unless additional seat, seat belt and falling object protection are provided.

The operator must satisfy himself that no one will be endangered before moving the machine.

Report any needed repairs noted during operation.

Carry implements close to the ground, approximately 40 cm (15 inch) above ground level.

Keep eye contact with the load at all times.

Stay a safe distance from the edge of cliffs, overhangs and slide areas.

Be careful to avoid the condition which could lead to tipping when working on hills, banks or slopes, and when crossing ditches, ridges or other obstructions.

Work up and down slopes, rather than sideways whenever possible.

Avoid changing the direction on travel on a slope, which could result in tipping or side slipping of the machine.

Bring the load close to the machine before traveling or swinging the load.

Keep the machine under control and do not work it over its capacity.

Be sure hitch points and the towing device are adequate.

Lifting capacity decreases as the load is moved further from the machine.

Connect trailing equipment to a drawbar or hitch only.

Never straddle a wire rope cable or similar device, nor allow others to do so.

No personnel should be between the machine and trailing equipment when maneuvering to connect them. Block the tongue or hitch of trailing equipment to align it with the drawbar or hitch.

Parking the Machine

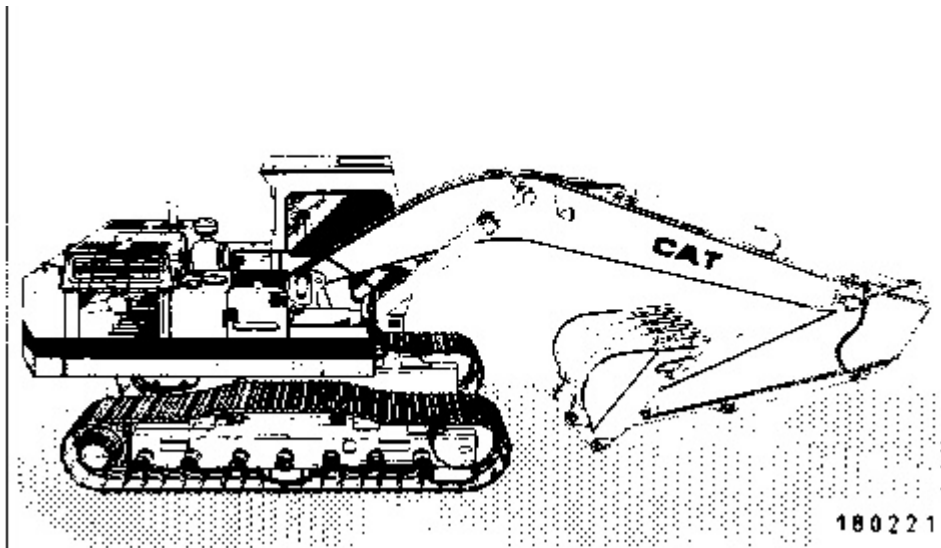

Park on a level surface. If necessary to park on a grade, block the machine.

Place the implements in the servicing position. (See illustration above.)

Stop the engine.

Turn the start switch key to the OFF position.

Remove the start switch key.

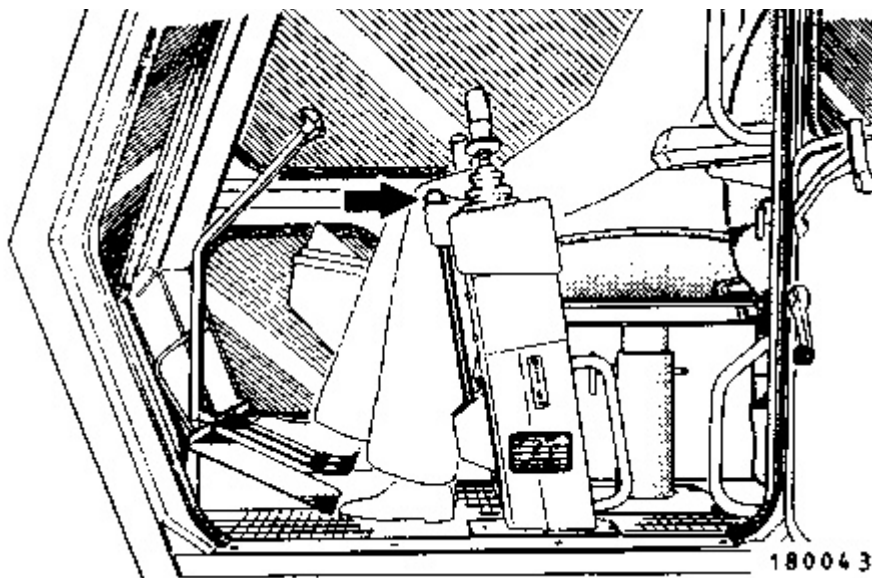

Move the hydraulic activation control lever to the locked position.

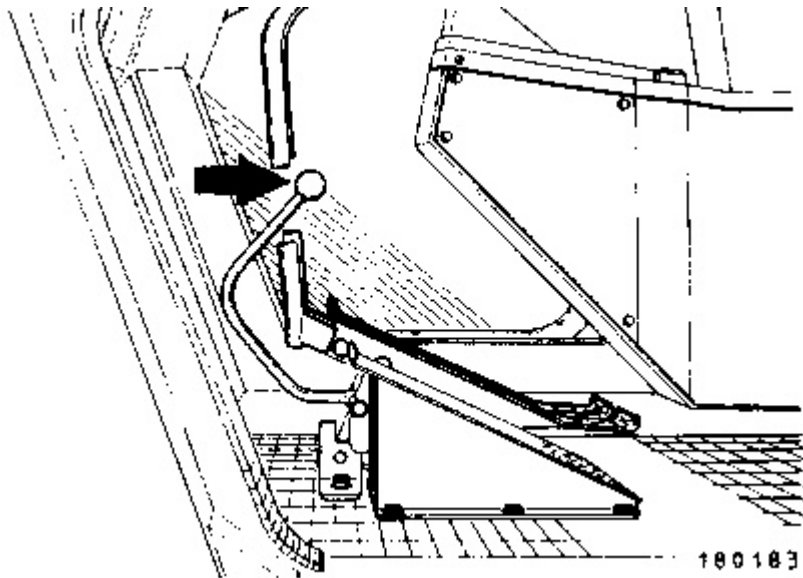

Move the travel lock lever to the locked position.

Product: EXCAVATOR

Model: EL180 EXCAVATOR 4EF

Configuration: E180 EL180 HYDRAULIC EXCAVATORS 4EF00001-UP (MACHINE) POWERED BY 3204 ENGINE

Operation and Maintenance Manual E180 AND EL180 HYDRAULIC EXCAVATORS

Media Number -XEBU9537-01

Publication Date -01/04/1987

Date Updated -30/01/2002

Towing

SMCS - 7606

Towing Procedures



Personal injury or death could result when improperly towing a disabled machine.

Block the machine to prevent movement before releasing the brakes. The machine can roll free if it is not blocked.

Relieve the hydraulic tank and line pressure before any disassembly. Operate the travel levers back and forth with the engine stopped to relieve pressure.

Follow the recommendations below, to properly perform the towing procedure.

NOTICE

To tow the machine, both final drives must be disengaged.

Do not operate the travel motors with the final drives disengaged. Damage could result.

These towing instructions are for moving a disabled machine a short distance, only a few feet at low speed, no faster than 2 km/h (1.2 mph), to a convenient location for repair. These instructions are for emergencies only. Always haul the machine if long distance moving is required.

Shielding must be provided on the towing machine, to protect the operator if the tow line or bar should break.

Do not allow riders on the machine being towed, unless the operator can control the steering and/or braking.

Before towing, make sure the tow line or bar is in good condition and has enough strength for the towing situation involved. Use a towing line or bar with a strength of at least 1.5 times the gross weight of the towing machine, for a disabled machine stuck in mud or when towing on a grade.

Attach cable to towing eye on front if pulling forward, or attach to drawbar pin if pulling to the rear.

Keep the tow line angle to a minimum. Do not exceed a 30° angle from the straight ahead position.

Quick machine movement could overload the tow line or bar and cause it to break. Gradual and smooth machine movement will work better.

Normally, the towing machine should be as large as the disabled machine. Satisfy yourself that the towing machine has enough brake capacity, weight and power, to control both machines for the grade and distance involved.

To provide sufficient control and braking when moving a disabled machine downhill, a larger towing machine or additional machines connected to the rear could be required. This will prevent it from rolling uncontrolled.

The different situation requirements cannot be given, as minimal towing machine capacity is required on smooth level surfaces to maximum on inclines or poor surface conditions.

Before Towing

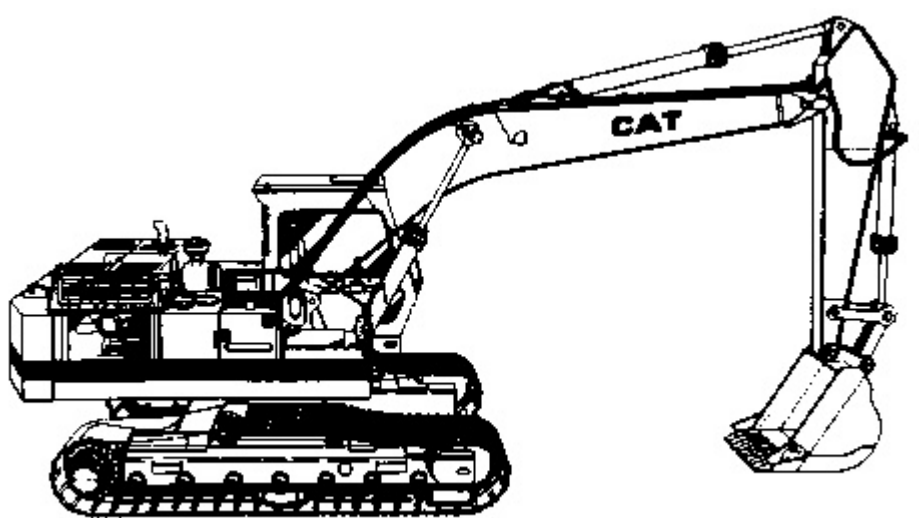

180239

1. Lower the implement to the ground with slight down pressure and stop the engine.

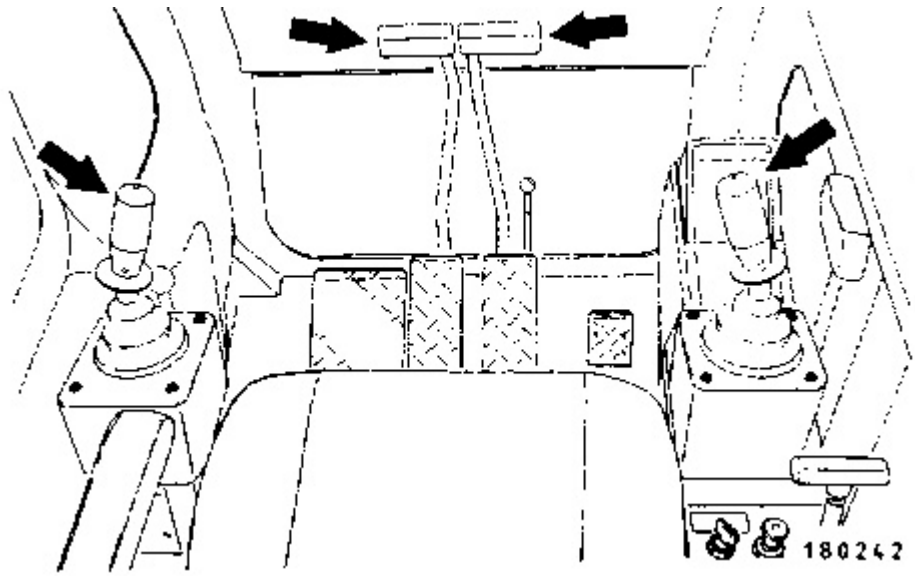

2. Operate the travel and control levers to relieve hydraulic line pressure.

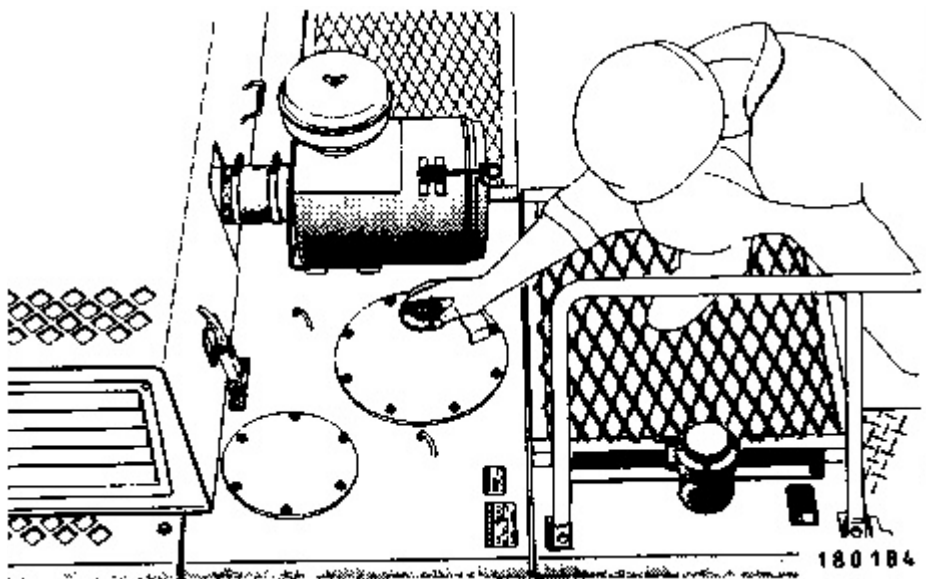

3. Loosen the pressure cap to relieve the hydraulic tank pressure.

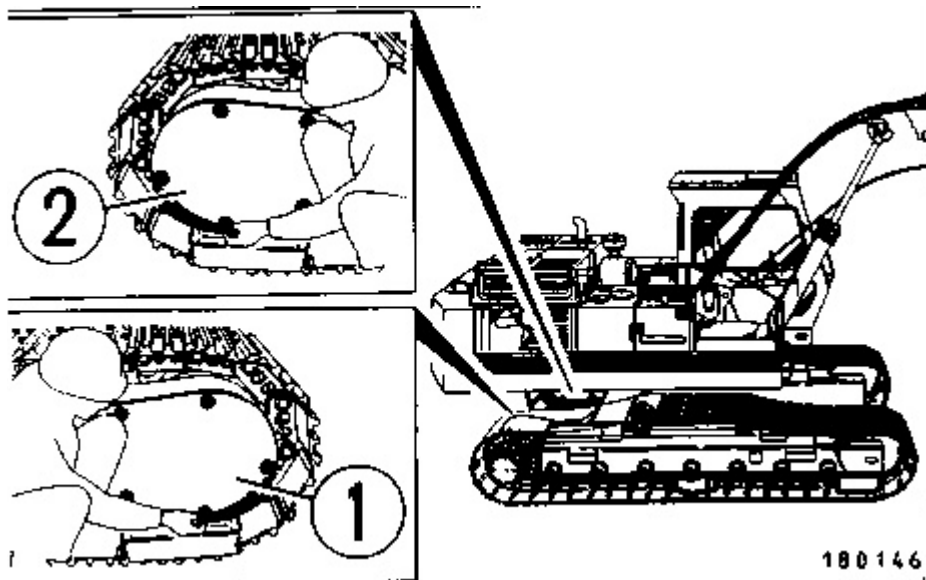

Thank you so much for reading.
Please click the “Buy Now!”
button below to download the
complete manual.



After you pay.

You can download the most
perfect and complete manual in
the world immediately.

Our support email:

ebooklibonline@outlook.com