

KEY	PART NO.	PART NAME	QTY	REMARKS
1	RE527858	SCREW	2	
2	R522409	HEAT SHIELD	1	
3	H23125	PLUG	4	
4	R123574	NUT	4	
5	R123575	O-RING	4	
6	R520896	VALVE COVER	1	(Not Illustrated) ORDER R543879
6	R543879	VALVE COVER	1	MARKED R543880
7	R524468	GASKET	1	
8	RE528742	DEFLECTOR	1	
9	19M7862	SCREW	1	M6 X 20

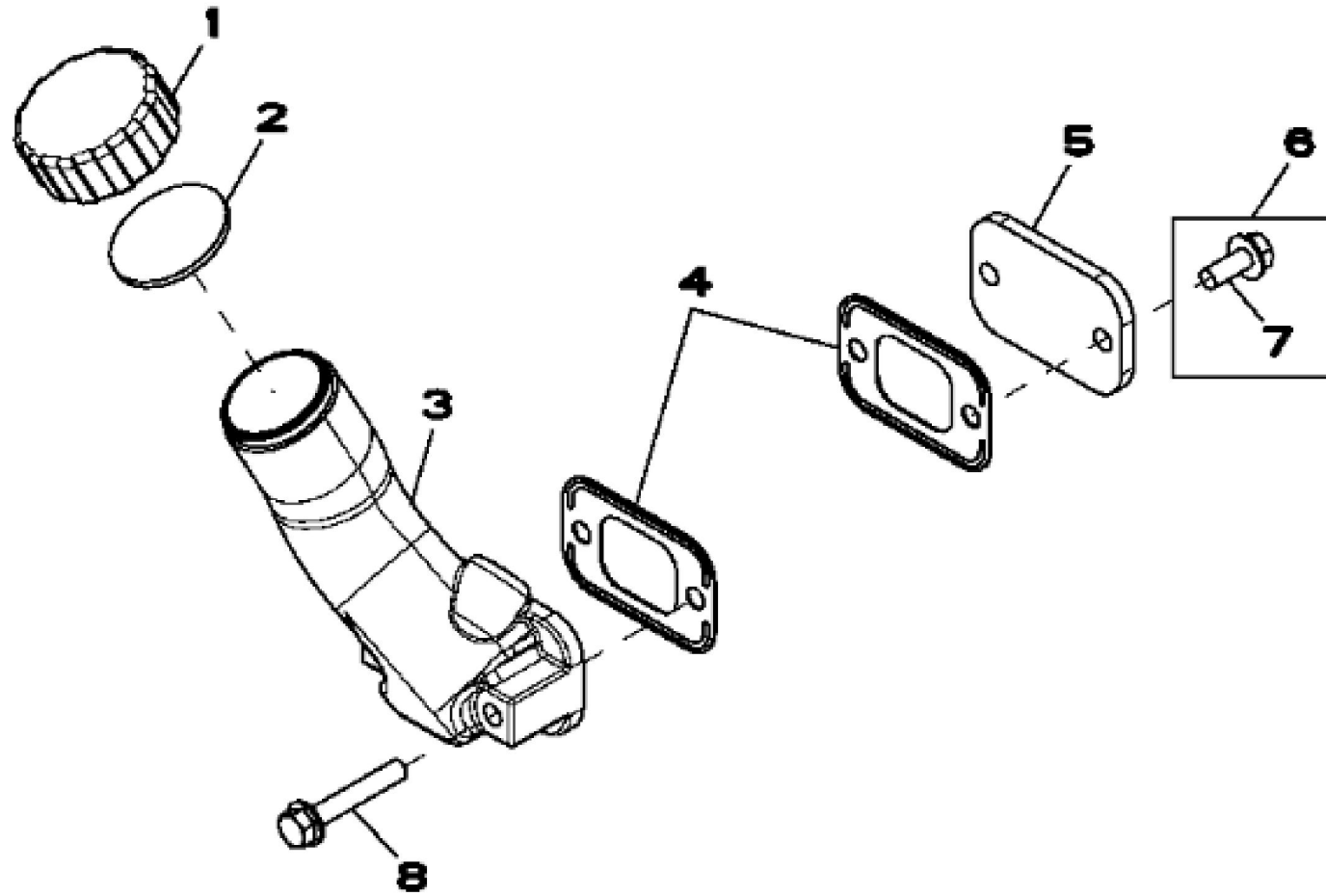

RE515712PCDD02

KEY	PART NO.	PART NAME	QTY	REMARKS	
1	R80136	FILLER CAP	1		
2	R80135	GASKET	1		
3	R517353	FILLER NECK	1		
4	R136495	GASKET	2		
5	R116296	COVER	1		
6	RE67238	SCREW	2	(WITH PRE-APPLIED SEALANT)	
7	19M7866	SCREW	1	M8 X 20	
8	19M7799	SCREW	2	M8 X 45	

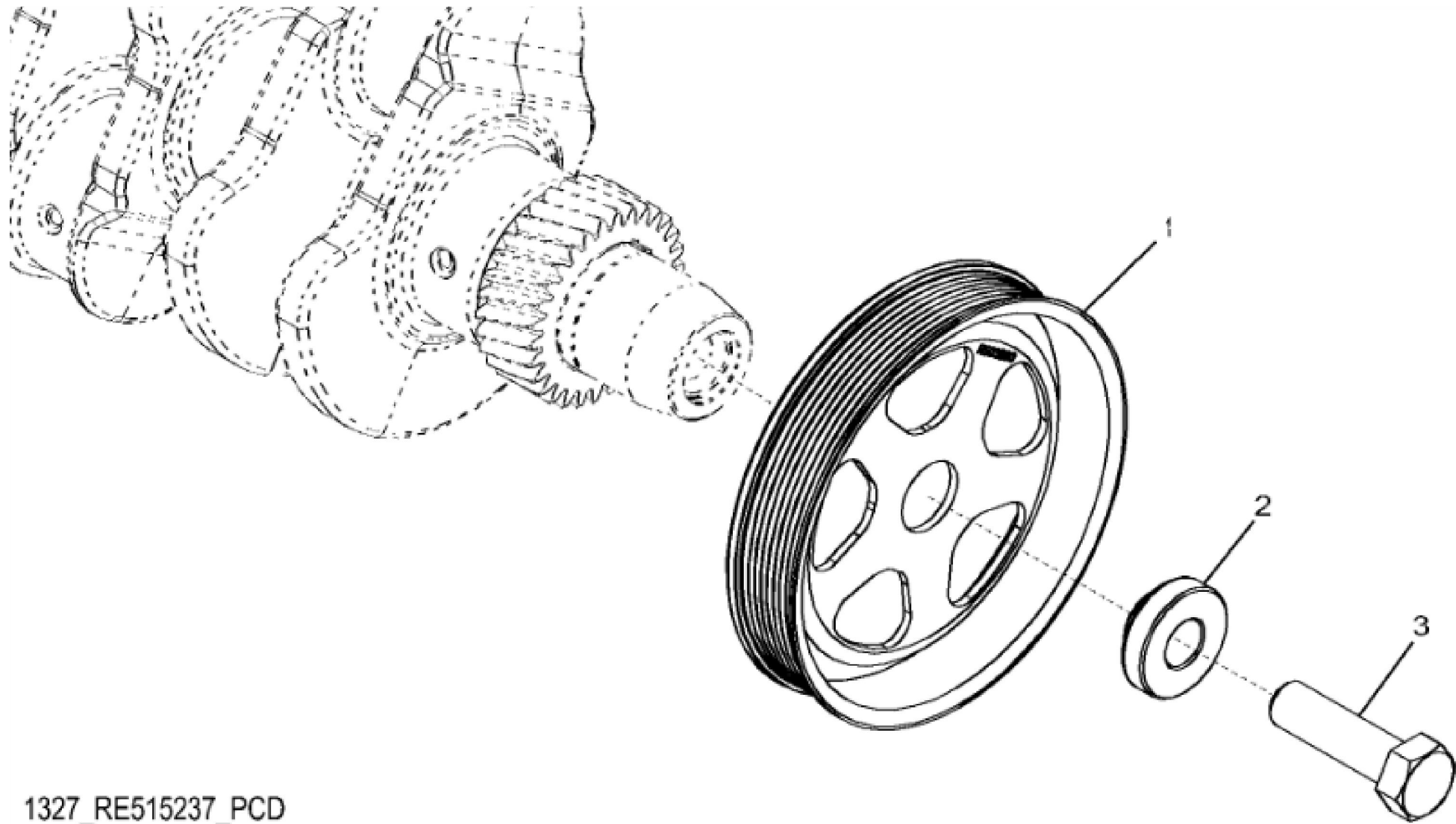

1327_RE515237_PCD

John Deere > Construction And Forestry >BACKHOE, LOADER >410J - BACKHOE, LOADER >410J Backhoe Loader >04A ENGINE 4045HL288-SE503031 >0400A ENGINE 4045HL288-SE503031 4045HL288
>ST308624 - 1327 CRANKSHAFT PULLEY

KEY	PART NO.	PART NAME	QTY	REMARKS	
1	R503880	PULLEY	1	OD = 188 mm	
2	R515040	BUSHING	1	OD = 50 mm	
3	R516648	CAP SCREW	1	M20 X 70	

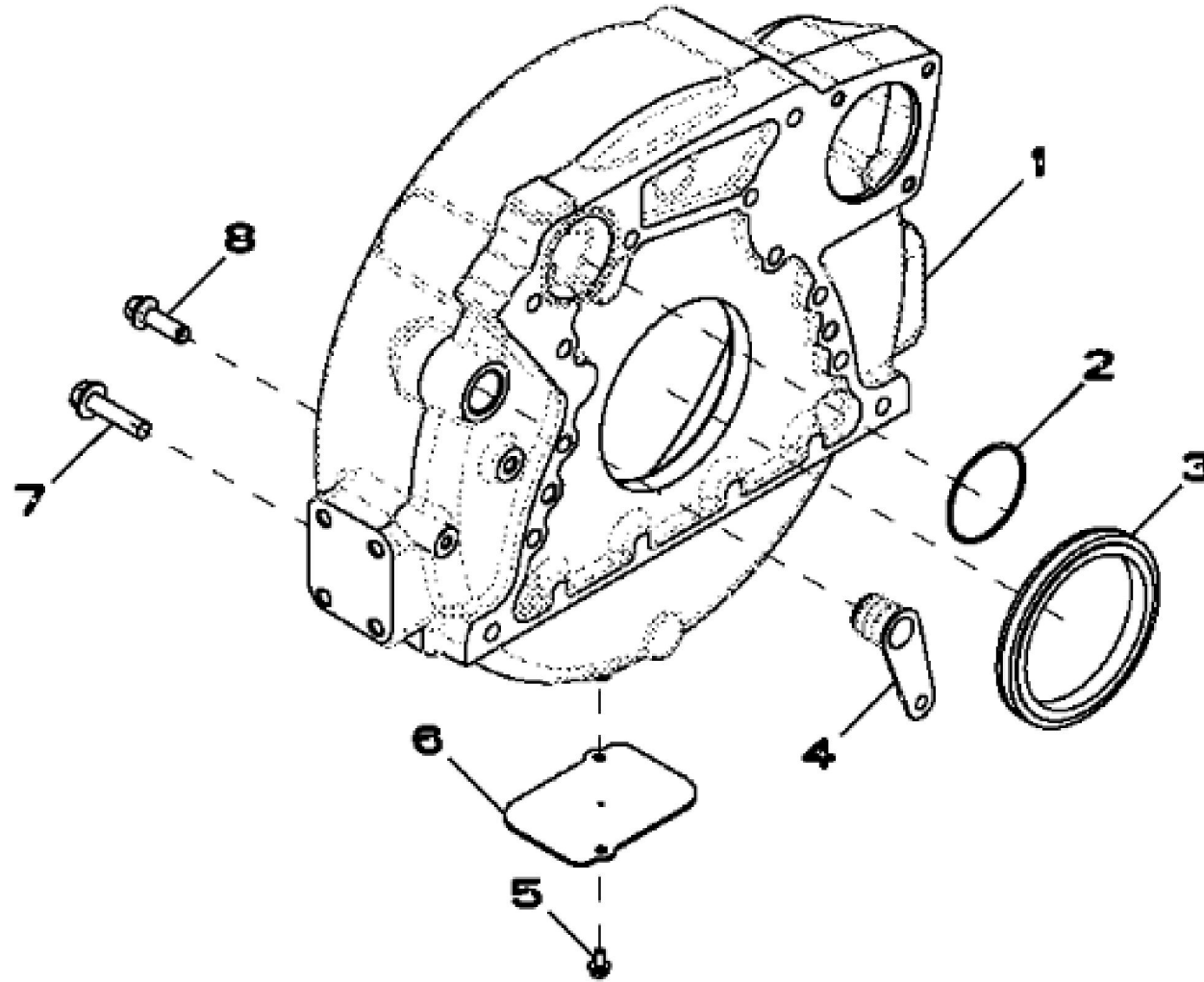

RE502001PCDE02

Thank you so much for reading.
Please click the “Buy Now!”
button below to download the
complete manual.



After you pay.

You can download the most
perfect and complete manual in
the world immediately.

Our support email:

ebooklibonline@outlook.com