

Page Title	Page Number
ENGINE ASSEMBLY-A4.236 ENGINE	1
SHORT ENGINE-A4.236 ENGINE	2
CYLINDER BLOCK-A4.236 ENGINE	3
CRANKSHAFT, PISTONS AND CONNECTING RODS-A4.236 ENGINE	4
CYLINDER HEAD-A4.236 ENGINE	5
ROCKER SHAFT-A4.236 ENGINE	6
TIMING GEAR AND CAMSHAFT-A4.236 ENGINE	7
BALANCER UNIT-A4.236 ENGINE	8
FUEL INJECTION EQUIPMENT-A4.236 ENGINE	9
LUBRICATING OIL SUMP-A4.236 ENGINE	10
LUBRICATING OIL FILTER AND INTEGRAL COOLER-A4.236 ENGINE	11
WATER PUMP, THERMOSTAT AND HEAT EXCHANGER-A4.236 ENGINE	12
FUEL SYSTEM AND FILTER-A4.236 ENGINE	13
AIR INDUCTION AND EXHAUST SYSTEM-A4.236 ENGINE	14
ALTERNATOR POSITIONER-A4.236 ENGINE	15
JOINTS AND GASKETS-A4.236 ENGINE	16
LUBRICATING OIL COOLER AND FILTER-A4.236 ENGINE	17
HEATER KIT-COLD CLIMATE	18
ALTERNATOR	19
ALTERNATOR-VALEO TYPE	20
ALTERNATOR-ISKRA TYPE	21
STARTER MOTOR-MARELLI TYPE	22
STARTER MOTOR-BOSCH	23
STARTER MOTOR-ISKRA TYPE	24
COOLING SYSTEM-FAN AND HOSES	25
COOLING SYSTEM-RADIATOR AND BRACKET	26
FUEL SYSTEM	27
FUEL TANK	28
DRY AIR FILTER-DRY AIR CLEANER	29
EXHAUST SYSTEM	30
EXHAUST SYSTEM	31
HAND AND FOOT THROTTLE CONTROLS	32
BATTERY	33
INSTRUMENT PANEL	34
INSTRUMENT PANEL	35
ELECTRICAL WIRING-FRONT	36
ELECTRICAL WIRING-REAR	37
LIGHTING EQUIPMENT	38
LIGHTING EQUIPMENT	39
LIGHTING EQUIPMENT	40
CLUTCH-O.M.G. - 11	41
CLUTCH-LUK - 11	42
CLUTCH-O.M.G. - 12	43
CLUTCH-LUK - 12	44
CLUTCH PEDAL AND LINKAGE	45
LOWER CLUTCH P.T.O.	46
CENTRE AXLE HOUSING AND TRANSMISSION HOUSING	47
CENTRE AXLE HOUSING AND TRANSMISSION HOUSING	48
TRANSMISSION	49
TRANSMISSION	50
SHIFT LEVERS	51
GEAR BOX	52
REDUCER OPTION-FOR SHUTTLE VERSION ONLY.	53
GEAR BOX-FOR SHUTTLE VERSION ONLY.	54
GEAR BOX-FOR SPECIAL OPTIONS VERSION ONLY	55
REDUCER OPTION-OVERDRIVE AND SHUTTLE VERSION	56
REDUCER OPTION-OVERDRIVE AND UNDERDRIVE VERSION	57
REDUCER OPTION-OVERDRIVE AND CREEPER VERSION	58
REDUCER OPTION-UNDERDRIVE AND SHUTTLE VERSION	59
REDUCER OPTION-UNDERDRIVE E CREEPER VERSION	60
REDUCER OPTION-SHUTTLE AND CREEPER VERSION	61
PTO SHAFT-STANDARD TYPE	62
PTO-CONTROL-540 R.P.M. STD	63
PTO SHAFT-540/750/1000 R.P.M.	64
PTO-CONTROL-540/750/1000 R.P.M.	65
TRANSFER GEAR BOX AND DRIVE SHAFT:	66

TABLE OF CONTENT

4 WHEEL DRIVE CONTROLS	67
REAR AXLE	68
REAR AXLE	69
REAR AXLE DIFFERENTIAL LOCK MECHANISM	70
DIFFERENTIAL LOCK CONTROLS	71
DIFFERENTIAL LOCK CONTROLS	72
BRAKE AND CONTROLS	73
BRAKE AND CONTROLS-DEVICE	74
BRAKE AND CONTROLS-PIPINGS	75
BRAKE AND CONTROLS-PIPINGS FRONT	76
BRAKES	77
MASTER CYLINDER-BRAKE PUMP	78
BRAKE CYLINDER	79
REAR WHEELS	80
FRONT WHEELS	81
FRONT AXLE 2 WHEEL DRIVE	82
FRONT AXLE 4 WHEEL DRIVE	83
FRONT AXLE 4 WHEEL DRIVE	84
FRONT AXLE 4 WHEEL DRIVE	85
STEERING HYDRAULIC LINES	86
STEERING HYDRAULIC LINES	87
STEERING HYDRAULIC LINES	88
STEERING ORBITROL UNIT-2 WHEEL DRIVE	89
STEERING ORBITROL UNIT-4 WHEELS DRIVE	90
STEERING-PUMP-TUROLLA	91
STEERING-PUMP-BOSCH	92
STEERING CYLINDER	93
STEERING CYLINDER	94
HYDRAULIC EQUIPMENT-HYDRAULIC LINES STD.	95
HYDRAULIC EQUIPMENT-SINGLE HYDRAULIC LINES	96
HYDRAULIC EQUIPMENT-SINGLE HYDRAULIC LINES	97
HYDRAULIC PUMP-TUROLLA	98
HYDRAULIC PUMP-BOSCH	99
HYDRAULIC PUMP-BOSCH	100
HYDRAULIC PUMP-TUROLLA	101
HYDRAULIC LIFT VALVE-WITH MECHANICS RISER	102
HYDRAULIC LIFT-WITH MECHANICS RISER	103
HYDRAULIC LIFT-WITH MECHANICS RISER	104
HYDRAULIC LIFT-WITH ELECTRONIC LIFT	105
HYDRAULIC LIFT-WITH ELECTRONIC LIFT	106
ELECTRICAL WIRING-WITH ELECTRONIC LIFT	107
HYDRAULIC LIFT VALVE-WITH ELECTRONIC LIFT	108
ELECTRICAL WIRING-CONTROL PANEL	109
ELECTRONIC LIFT	110
MECHANICAL CONTROL LIFT	111
MECHANICAL CONTROL LIFT	112
MECHANICAL CONTROL LIFT	113
AUXILIARY HYDRAULIC VALVE LINES	114
AUXILIARY HYDRAULIC VALVE LINES	115
PLATE FOR AUXILIARY HYDRAULIC VALVE-HIDROIRMA TYPE.	116
AUXILIARY HYDRAULICS VALVE STANDARD-HYDROIRMA TYPE STANDARD	117
AUXILIARY HYDRAULICS FLOATING-HYDROIRMA TYPE FLOATING	118
AUXILIARY HYDRAULIC VALVE LINES	119
AUXILIARY HYDRAULICS-CONTROL WITH 1.0 AND 2.0 DISTRIBUTOR.	120
AUXILIARY HYDRAULIC VALVE LINES-SINGLE HYDRAULIC LINES	121
AUXILIARY HYDRAULICS VALVE-TILL TYPE STANDARD	122
AUXILIARY HYDRAULICS VALVE-TILL TYPE FLOATING	123
LINKAGE	124
LINKAGE-MECANICS LIFT CYLINDER RIGTH	125
HYDRAULIC LIFT CYLINDER-HYDRAULIC LIFT CYLINDER,WITH 1'AND 2'AUXIL.HYD	126
LINKAGE	127
SHEET METAL	128
SHEET METAL	129
SIDE COVER-SHIELD FAN	130
SHEET METAL	131
DECALS	132
DECALS	133
DECALS	134

TABLE OF CONTENT

FENDERS - FRONT	135
FENDERS AND PLATFORM	136
FENDERS AND PLATFORM	137
REAR SHEET METAL	138
SEAT	139
SEAT	140
SEAT	141
SAFETY FRAME	142
ROTATING LIGHT	143
WEIGHT FRAME AND WEIGHTS W	144
HITCH CONNECTIONS-WITHOUT HITCH	145
REAR HOOK	146
DRAWBAR-HEAVY DUTY	147
DRAWBAR-	148
TOOL KIT	149
SEALERS AND LIQUID GASKETS ADHESIES	150
REDUCER OPTION	151
REDUCER OPTION-SHUTTLE AND CREEPER VERSION	152
REDUCER OPTION-OVERDRIVE AND CREEPER VERSION	153
REAR HOOK	154

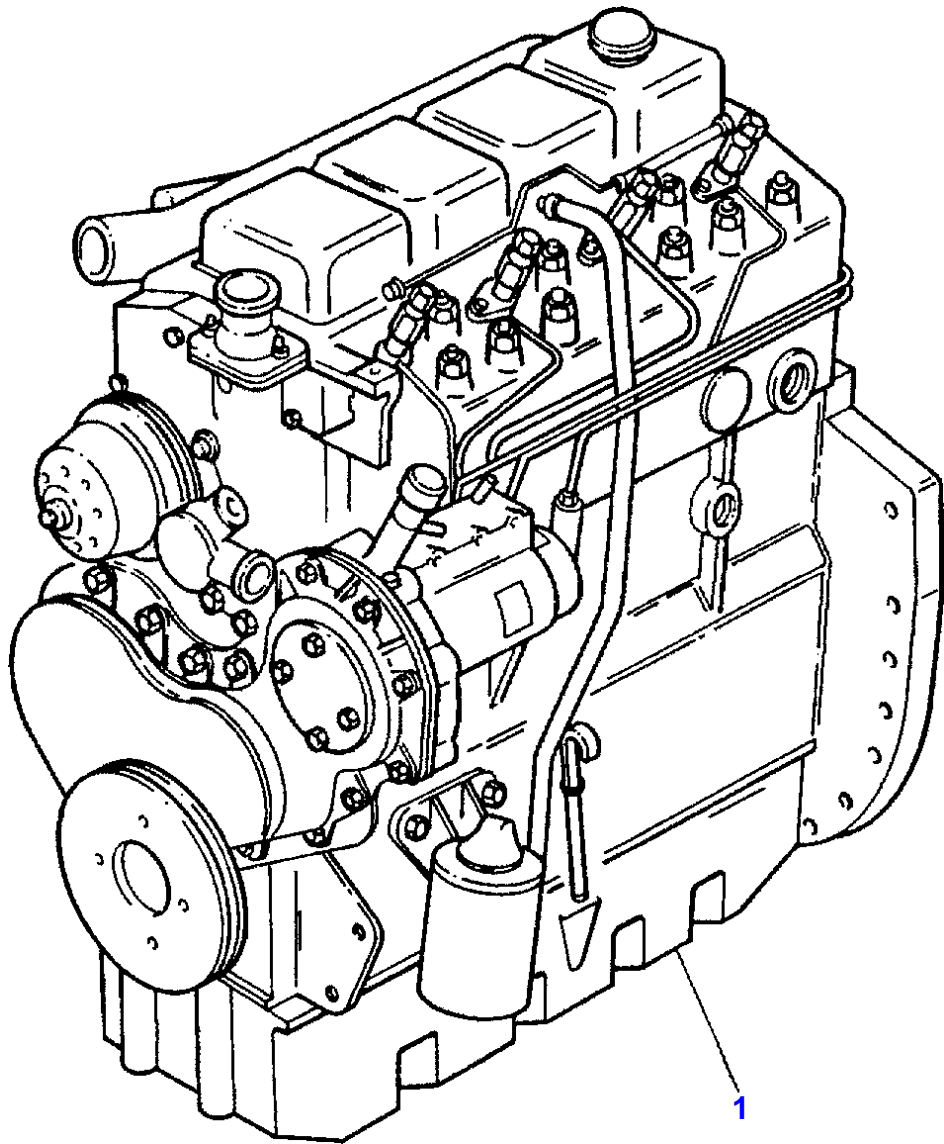

MASSEY FERGUSON

MF 374 V FOOTSTEP TRACTOR - 3540306

3540306

ENGINE ASSEMBLY-A4.236 ENGINE

1

Item	Part Number	Qty	Description	Comments
1	3553131M91	1	Engine	"LD31202"PK

Thank you so much for reading.
Please click the “Buy Now!”
button below to download the
complete manual.



After you pay.

You can download the most
perfect and complete manual in
the world immediately.

Our support email:

ebooklibonline@outlook.com