

FORD



Operator's Manual

MODEL 1120

Tractor

42112030



Reprinted



F1067

PLEASE READ CAREFULLY :

For a complete list of the pre-delivery service checks performed by your dealer, refer to PRE-DELIVERY SERVICE on the upper portion of page 61 and 63. The copy on page 61 is your record of the service performed, and the copy on page 63, which is to be removed from the manual, is your dealer's. MAKE SURE THAT YOU AND THE DEALER SIGN BOTH COPIES.

After you have operated your tractor for fifty hours, take this manual and your tractor to your dealer. He will then perform the factory recommended 50-HOUR SERVICE as listed on the lower portions of pages 61 and 63 – without charge – except for lubricant, oil, or filters replaced as part of normal maintenance. MAKE SURE THAT YOU AND THE DEALER SIGN BOTH COPIES.

A PRODUCT IDENTIFICATION PLATE is located on the left-hand side of the transmission housing. The numbers on the plate are important should your tractor require future service. For your convenience, have your dealer record the numbers in the appropriate spaces below.

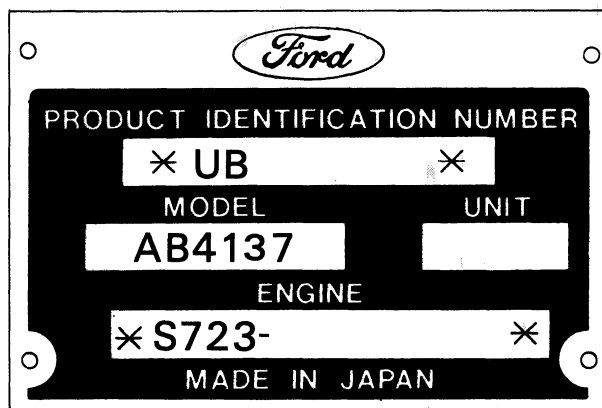
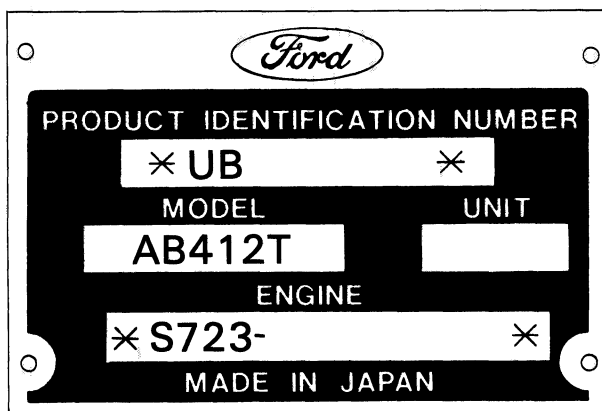

Ford New Holland policy is one of continuous improvement, and the right to change prices, specification or equipment at any time without notice is reserved.





















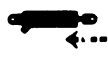



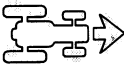



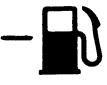

All data given in this book is subject to production variations. Dimensions and weights are approximate only and the illustrations do not necessarily show tractors in standard condition. For exact information about any particular tractor please consult your Ford New Holland Dealer.

CONTENTS

INTERNATIONAL SYMBOLS	3
SAFETY PRECAUTIONS	4-5
CONTROLS AND INSTRUMENTS	6-12
SEAT, SEAT BELT AND ROPS	6
LIGHTING	7
INSTRUMENT PANEL	7-9
THROTTLE CONTROLS	9
BRAKE CONTROLS	9-10
DIFFERENTIAL CONTROL	10
MECHANICAL TRANSMISSION AND PTO CONTROLS	10-11
HYDROSTATIC TRANSMISSION CONTROLS	11-12
HYDRAULIC LIFT SYSTEM CONTROLS	12
OPERATION	12-25
BREAK-IN PROCEDURES	13
STARTING THE ENGINE	13-14
STOPPING THE ENGINE	14
OPERATING THE MECHANICAL AND HYDROSTATIC TRANSMISSIONS, FOUR-WHEEL DRIVE AND PTO	14-17
TOWING THE TRACTOR	17
OPERATING THE DIFFERENTIAL LOCK	17-18
OPERATING THE HYDRAULIC LIFT SYSTEM	18-19
DRIVING THE TRACTOR	20
WHEEL TREAD SETTINGS	21-22
TRACTOR WEIGHTING	22-24
TIRE PRESSURES	24-25
LUBRICATION AND MAINTENANCE	26-48
LUBRICATION AND MAINTENANCE CHART	26-27
TWO-WHEEL DRIVE	26
FOUR-WHEEL DRIVE	27
FUEL AND LUBRICANTS	28-31
FUEL AND LUBRICANT SERVICE PROCEDURES	31-36
GENERAL MAINTENANCE	36-46
TRACTOR STORAGE	46-47
GENERAL TORQUE SPECIFICATION TABLE	48
SPECIFICATIONS	49-52
SAFETY AND INSTRUCTION DECALS	53-58
PREDELIVERY AND 50-HOUR SERVICE	61-63

INTERNATIONAL SYMBOLS

As a guide to the operation of your tractor, various international symbols have been utilized on the instruments and controls. The symbols are shown below with an indication of their meaning.

	Engine speed		Glow		Control lever operating direction
	Hours recorded		Engine stop		Rock shaft (raised)
	Engine water temperature		Engine oil		Rock shaft (lowered)
	Air filter		Parking brake		Remote cylinder (float)
	Engine oil pressure		Lights (upper beam)		Remote cylinder (retracted)
	Hazard warning		Lights (lower beam)		Remote cylinder (extended)
	Axle connect		Lock		Forward
	Axle disconnect		Release lock		Warning! contains asbestos
	Continuously variable		Up		
	Increase		Down		
	Decrease		Differential lock		
	Fuel level		Read operator's manual		
	Creeper range		Battery		
	High range		Power take-off (on)		
	Middle range		Power take-off (off)		
	Low range		"Tortoise," slow or minimum setting		
	Neutral		"Hare," fast or maximum setting		
	Diesel fuel		Warning		

F1001

SAFETY PRECAUTIONS

The following precautions are suggested to help prevent accidents.

A careful operator is the best operator. Most accidents can be avoided by observing certain precautions. Read and take the following precautions before operating this tractor to help prevent accidents. Equipment should be operated only by those who are responsible and instructed to do so.

THE TRACTOR

1. Read the Operator's Manual carefully before using the tractor. Lack of operating knowledge can lead to accidents.
2. Use an approved Rollbar and Seat Belt for safe operation. Overturning a tractor without a rollbar can result in death or injury. If your tractor is not equipped with a rollbar and seat belt, see your Ford New Holland Dealer.
3. Always use the seat belt. Do not use the seat belt if the rollbar has been removed from the tractor.
4. If a front end loader is to be installed, always use a FOPS canopy to avoid injury from falling objects.
5. Use the handholds and step plates when getting on and off the tractor to prevent falls. Keep steps and platform cleared of mud and debris.
6. Do not permit anyone but the operator to ride on the tractor. There is no safe place for extra riders.
7. Replace all missing, illegible, or damaged safety decals. See list of decals on page 57
8. Keep safety decals clean of dirt and grime.

SERVICING THE TRACTOR

1. The cooling system operates under pressure which is controlled by the radiator cap. It is dangerous to remove the cap while system is hot. Always turn cap slowly to the first stop and allow the pressure to escape before removing the cap entirely.
2. Do not smoke while refueling the tractor. Keep any type of open flame away. Wait for engine to cool before refueling.
3. Keep the tractor and equipment, particularly brakes and steering, maintained in a reliable and satisfactory condition to ensure your safety and comply with legal requirements.
4. Keep open flame away from battery or cold weather starting aids to prevent fires or explosions. Use jumper cables according to instructions to prevent sparks which could cause explosion.
5. Stop the engine before performing any service on the tractor.
6. Escaping hydraulic/diesel fluid under pressure can penetrate the skin causing serious injury.
 - **DO NOT** use your hand to check for leaks. Use a piece of cardboard or paper to search for leaks.
 - Stop engine and relieve pressure before connecting or disconnecting lines.
 - Tighten all connections before starting engine or pressurizing lines.

If fluid is injected into the skin obtain medical attention immediately or gangrene may result.

7. Do not modify or alter or permit anyone else to modify or alter this tractor or any of its components or any tractor function

without first consulting a Ford New Holland Dealer.

8. The fuel oil in the injection system is under high pressure and can penetrate the skin. Unqualified persons should not remove or attempt to adjust a pump, injector, nozzle or any other part of the fuel injection system. Failure to follow these instructions can result in serious injury.
9. Continuous long term contact with used engine oil may cause skin cancer. Avoid prolonged contact with used engine oil. Wash skin promptly with soap and water.
10. Some components on your tractor, such as gaskets and friction surfaces (brake linings, clutch linings etc.), may contain asbestos. Breathing asbestos dust is dangerous to your health. You are therefore advised to have any maintenance or repair operations on such components carried out by an authorized Ford New Holland Dealer. If however, service operations are to be undertaken on parts that contain asbestos, the essential precautions listed below must be observed:
 - Work out of doors or in a well ventilated area.
 - Dust found on the tractor or produced during work on the tractor should be removed by extraction not by blowing.
 - Dust waste should be dampened, placed in a sealed container and marked to ensure safe disposal.
 - If any cutting, drilling, etc., is attempted on materials containing asbestos, the item should be dampened and only hand tools or low speed power tools used.

OPERATING THE TRACTOR

1. Apply the parking brake, place the P.T.O. lever in the "OFF" position, the lift control lever in the down position, the remote control valve levers in the neutral position, and the transmission in neutral before starting the tractor.
2. Do not start the engine or operate controls while standing beside the tractor. Always sit in the tractor seat when starting the engine or operating controls.
3. Do not bypass the neutral start switches. Consult your Ford New Holland Dealer if your neutral start controls malfunction. Use jumper cables only in the recommended manner. Improper use can result in tractor runaway.
4. Avoid accidental contact with the gear shift levers while the engine is running. Unexpected tractor movement can result from such contact.
5. Do not get off the tractor while it is in motion.
6. Disengage PTO, shut off the engine and apply the parking brake before getting off the tractor.
7. Do not park the tractor on a steep incline.
8. Do not operate the tractor engine in an enclosed building without adequate ventilation. Exhaust fumes can cause death.
9. If power steering or engine ceases operating, stop the tractor immediately.
10. Pull only from the drawbar or the lower link drawbar in the down position. Use only a drawbar pin that locks in place. Pulling from the tractor rear axle or any point above the axle may cause the tractor to upset.

(cont.)

SAFETY PRECAUTIONS (Continued)

11. If the front end of the tractor tends to rise when heavy implements are attached to the three-point hitch, install front end or front wheel weights. Do not operate the tractor with a light front end.
12. Always set the hydraulic selector lever in position control when attaching equipment and when transporting equipment. Be sure hydraulic couplers are properly mounted and will disconnect safely in case of accidental detachment of implement.
13. Do not leave equipment in the raised position.
14. Use the Flasher/Turn Signal Lights and SMV signs when traveling on public roads both day and night unless prohibited by law.
15. Be sure tractor lights are adjusted to prevent blinding an oncoming vehicle operator.

DRIVING THE TRACTOR

1. Watch where you are going especially at row ends, on roads, around trees and low hanging obstacles.
2. To avoid upsets drive the tractor with care and at speeds compatible with safety, especially when operating over rough ground, when crossing ditches or slopes, and when turning corners.
3. Lock tractor brake pedals together when transporting on roads to provide two wheel braking.
4. Keep the tractor in the same gear when going downhill as used when going uphill. Do not coast or free wheel down hills.
5. Any towed vehicle whose total weight exceeds that of the towing tractor must be equipped with brakes for safe operation.
6. When the tractor is stuck or tires are frozen to the ground, back up the tractor to prevent upset.
7. Always check overhead clearance, especially when transporting the tractor.
8. When operating at night, adjust lights to prevent blinding an oncoming driver.

OPERATING THE P.T.O.

1. When operating P.T.O. driven equipment, shut off the engine and wait until the P.T.O. stops before getting off the tractor and disconnecting the equipment.
2. Do not wear loose clothing when operating the power take-off, or when near rotating equipment.
3. When operating stationary P.T.O. driven equipment, always place both gear shift levers in neutral, apply the tractor parking brake and block the rear wheels front and back.

4. To avoid injury, do not clean, adjust, unclog or service P.T.O. driven equipment when the tractor engine is running.
5. Make sure the P.T.O. master shield is installed at all times and always replace the P.T.O. shield cap when the P.T.O. is not in use.

DIESEL FUEL

1. Under no circumstances should gasoline, alcohol or blended fuels be added to diesel fuel. These combinations can create an increased fire or explosive hazard. Such blends are more explosive than pure gasoline in a closed container such as a fuel tank. **Do not use these blends.**
2. Never remove the fuel cap or refuel with the engine running or hot.
3. Do not smoke while refueling or when standing near fuel.
4. Maintain control of the fuel filler pipe nozzle when filling the tank.
5. Do not fill the fuel tank to capacity. Allow room for expansion.
6. Wipe up spilled fuel immediately.
7. Always tighten the fuel tank cap securely.
8. If the original fuel tank cap is lost, replace it with a Ford approved cap. A non-approved, proprietary cap may not be safe.
9. Keep equipment clean and properly maintained.
10. Do not drive equipment near open fires.
11. Never use fuel for cleaning purposes.
12. Arrange fuel purchases so that winter grade fuels are not held over and used in the spring.

SAFETY FRAME (ROPS)

If your Ford Tractor is equipped with a safety frame it must be maintained in a serviceable condition. Be careful when driving through doorways or working in confined spaces with low headroom.

Under no circumstances :

1. ...modify, drill or alter the safety frame in any way as doing so could render you liable to legal prosecution.
2. ...attempt to straighten or weld any part of the main frame or retaining brackets which have suffered damage. By doing so you may weaken the structure and endanger your safety.
3. ...secure any parts on the main frame or attach your safety frame with other than the special high tensile bolts and nuts specified.
4. ...attach chains or ropes to the main frame for pulling purposes.
5. ...take unnecessary risks even though your safety frame affords you the maximum protection possible.

When you see this symbol



it means :

ATTENTION BECOME ALERT! YOUR SAFETY IS INVOLVED!

CONTROLS AND INSTRUMENTS

SEAT, SEAT BELT AND ROPS

TRACTOR SEAT

Your Ford 1120 Tractor is equipped with a molded cushion seat as shown in Figure 1. The seat is adjustable to obtain the most comfortable position. To move the seat fore and aft, move the release lever to the side and slide the seat fore and aft as required, Figure 2.

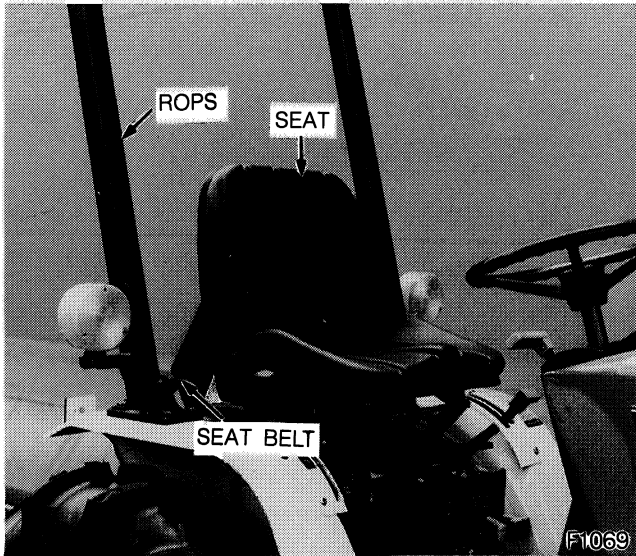

Figure 1 – Tractor Seat, ROPS and Seat Belt



Figure 2 – Tractor Seat Adjustment

ROLLOVER PROTECTIVE STRUCTURE (ROPS)

A Roll Over Protective Structure (ROPS) and seat belts were standard equipment for this tractor at

time of factory assembly. If the ROPS was deleted by the original purchaser or has been removed, it is recommended that you equip your tractor with a Roll Over Protective Structure (ROPS) and seat belts. ROPS are effective in reducing injuries during tractor overturn accidents. Overturning tractor without a ROPS can result in serious injury or death.

Roll Over Protective Structure (ROPS), and seat belts are available from your Ford New Holland Dealer.

The safety offered by the roll bar and seat belt is minimized if your seat belt is not buckled. Always use your seat belt – they save lives.



WARNING: Always wear the seat belt when the tractor is equipped with a ROPS. DO NOT use the seat belt if the ROPS is removed from the tractor.



WARNING: DO NOT attach chains or ropes to the roll bar for pulling purposes since the tractor can tip backward. Always pull from the tractor drawbar. Be careful when driving through door openings or under low overhead objects. Make sure there is sufficient overhead clearance for the roll bar.

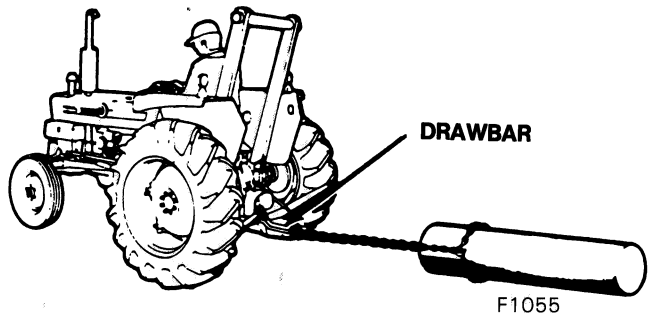

ADJUSTING THE SEAT BELT

To lengthen the belt, tip the buckle end down and pull on the buckle until the ends can be joined.

To shorten the belt, buckle it, then pull on the loose end until the belt is snug.

If the seat belt is to be cleaned, use soap and water. Do not use carbon tetrachloride, naphtha, etc., as these will weaken the webbing. For the same reason, do not bleach or redye the webbing. Replace seat belt if worn or damaged.

CONTROLS AND INSTRUMENTS

LIGHTING

FLASHER WARNING LAMP

Your Ford tractor is equipped with flasher warning lamps, Figure 3. The switch for the warning lamps is located on the right side of the instrument panel, Figure 4.

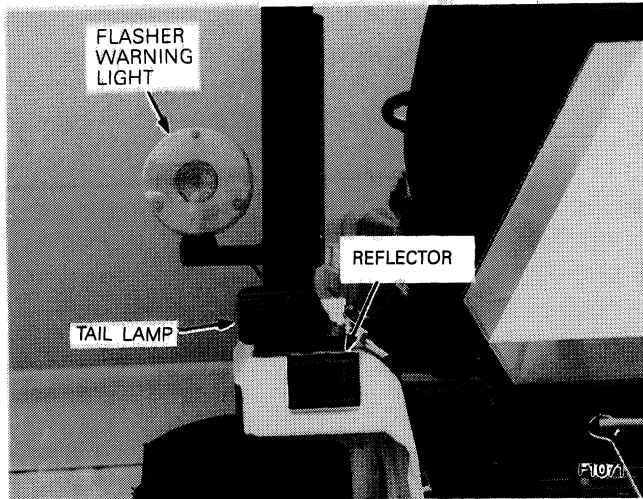

Figure 3 - Flasher Warning and Tail Lamp

The light switch must be turned to the "ON" position before the flasher will operate.

For your protection, use the flasher warning lamp and the SMV emblem when traveling on public roads, day or night.

LIGHT SWITCH

The light switch, shown in Figure 4, is a dial type switch. Its positions are :

Turning counter-clockwise "OFF"
Turning clockwise Headlights and Tail Lamps "ON"

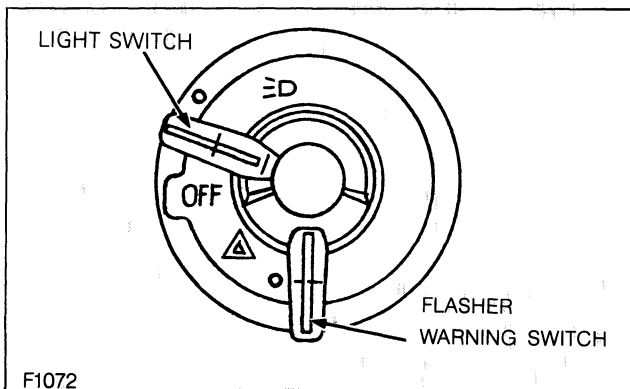

Figure 4 - Combination Switch

INSTRUMENT PANEL

KEY SWITCH

The key switch is shown in Figure 5. Turning the key to the left will activate the cold-start aid. Turning the key to the right to the "on" position will activate the warning lights and instruments. Turning the key further right to the "start" position will start the engine. Upon release, the key will spring return to the "on" position.

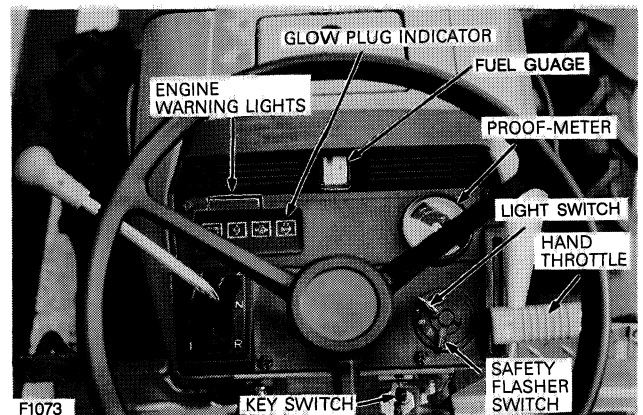

Figure 5 - Instrument Panel

The starting circuit can only be activated when the clutch pedal is fully depressed and the P. T. O. control lever and mid P. T. O. control lever (if equipped) are in the "OFF" position. Always check to make certain the transmission main shift lever and P. T. O. levers are in neutral before attempting to start the engine. Refer to page 13 for complete starting instructions.

IMPORTANT: The key switch must remain in the ON position while operating the engine. The warning lights and battery charging system will not function with the switch in the OFF position.

FUEL GAUGE

The fuel gauge is shown in Figure 6. The gauge indicates the level of fuel in the tank.

CONTROLS AND INSTRUMENTS

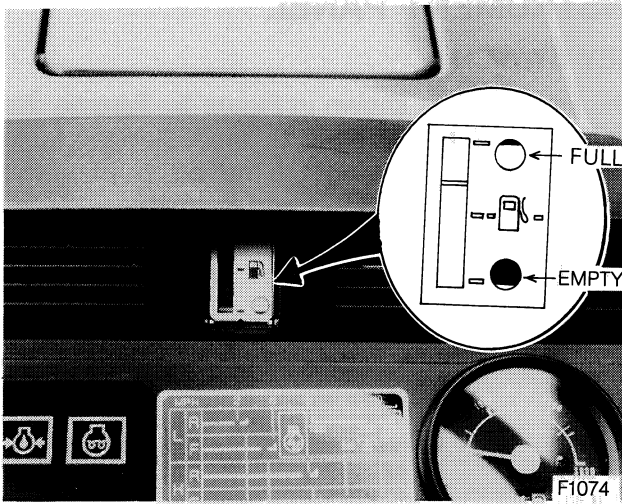

Figure 6 – Fuel Gauge

FUEL SHUTOFF VALVE

The fuel shutoff valve is shown in Figure 7. To open the fuel shutoff valve, move the handle so that it points straight up and down. To close the fuel shutoff valve, move the handle to the horizontal position. Always shut off the valve when servicing any portion of the fuel system.

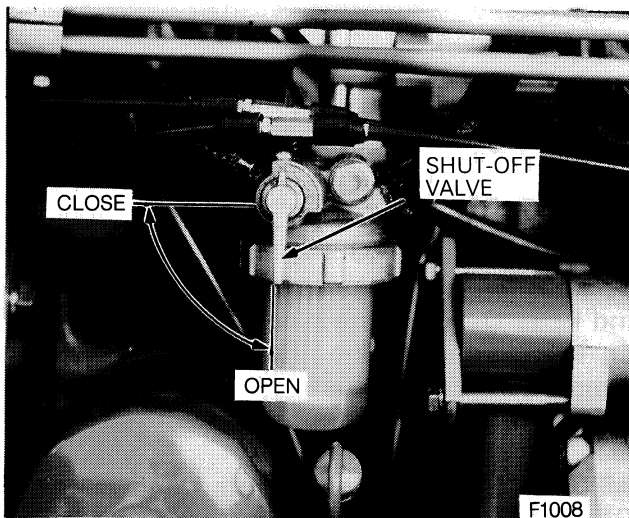

Figure 7 – Fuel Shutoff Valve

WARNING LIGHTS

The engine temperature, oil pressure and charge indicator warning lights are located as shown in Figure 5. When the key switch is turned "on" the oil pressure and charge lights come on. After the engine has been started, the lights should go out within a few seconds. If they do not go out :

- Engine oil pressure warning light : Stop the engine immediately and investigate the cause. It is important to remember that this light indicates oil pressure only. The operator must regularly check the crankcase for proper oil level.
- Charge indicator warning light : This is an indication that the charging system is not operating normally. Investigate the cause as soon as possible, otherwise the battery will become fully discharged.
- Coolant temperature warning light: The warning light is not on under normal operating conditions. If the light comes on, stop the engine and investigate. Regularly check the radiator for proper coolant level.



WARNING : When engine is at operating temperature always relieve pressure in the cooling system before removing the radiator cap.

- The glow plug indicator warning light : This light comes on when turning the key switch to the "HEAT" position and "START" position. Refer to page 13 for starting engine information.

NOTE : Make certain that all warning lights turn on for a moment when turning the key switch to the "START" position. If one of the warning lights does not turn on, the bulb should be replaced.

PROOF-METER

The Proof-Meter is located on the left side of the instrument panel, Figure 5. The Proof-Meter indicates :

- The hours and portions of hours your tractor has operated, based on an average engine speed of 2000 rpm. Engine speeds below 2000 rpm accumulate engine hours at a slower rate than clock hours. Engine speeds above 2000 rpm accumulate engine hours faster than clock hours. Use the Proof-Meter as a guide to determine hourly service and maintenance intervals.

CONTROLS AND INSTRUMENTS

- Engine revolutions per minute are indicated on a scale as shown in Figure 5. Use the engine revolutions per minute scale when operating PTO-driven equipment. PTO-driven equipment must be operated at an engine speed not to exceed, that indicated by the yellow line on the rpm scale (2385 rpm on mechanical-transmission tractors. 2300 with hydrostatic transmission). Additional information on P. T. O. operation can be found on page 16. Ground speeds are indicated on a decal attached to the instrument panel (H.S.T.) or to the top of the left fender (mechanical transmission tractor) with engine speeds from 1500 to rated rpm. Additional ground speed information can be found on page 52. The decal on hydrostatic transmission tractors shows ground speed for both ranges.

THROTTLE CONTROLS

HAND THROTTLE AND ENGINE STOP CONTROL

The hand throttle is shown in Figure 5. Push the throttle forward to increase engine rpm. Pull the throttle rearward to decrease engine rpm. Turning the key switch to the "OFF" position stops the engine.

FOOT THROTTLE

(Only mechanical transmission)

The foot throttle, shown in Figure 8, can be used separately, or in conjunction with the hand throttle. With the hand throttle control lever set at a selected engine rpm, the foot throttle can be used to increase engine rpm to its maximum speed. Upon release of the foot throttle, the engine speed will return to the rpm at which the hand throttle has been set, or idle if the hand throttle is not at a pre-set position.

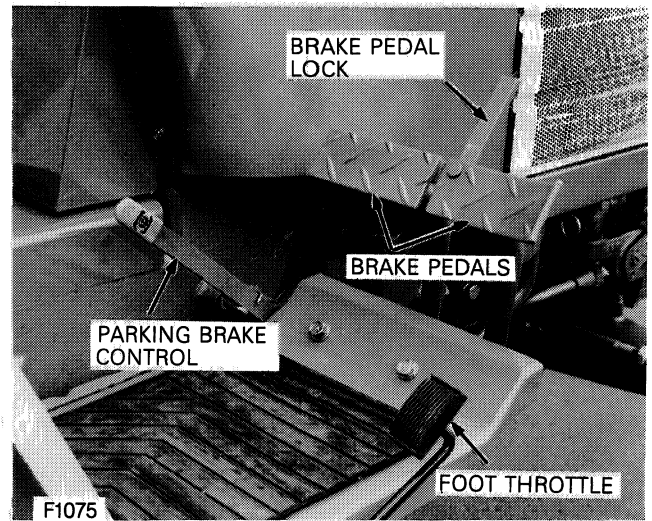

Figure 8 – Foot Throttle and Brake Controls

BRAKE CONTROLS

BRAKE PEDALS

The brake pedals are shown in Figure 8. The right brake pedal is used to brake the right rear wheel. The left pedal is used to brake the left rear wheel. Depress both pedals simultaneously to stop the tractor.

To assist in making sharp turns at slow speed, depress the right or left brake pedals as required.



WARNING: When operating the tractor at high speeds, never attempt to make sharp turns by using the brakes.

BRAKE PEDAL LOCK

The brake pedal lock, shown in Figure 8, is used to secure the brake pedals together. Lock the pedals together whenever the tractor is operated at high speeds and at any time the tractor is used on the highway.

PARKING BRAKE CONTROL

The parking brake, shown in Figure 8, is used for locking the brake pedals in the applied position. The parking brake should be applied whenever the tractor is parked.

Thank you so much for reading.
Please click the “Buy Now!”
button below to download the
complete manual.



After you pay.

You can download the most
perfect and complete manual in
the world immediately.

Our support email:

ebooklibonline@outlook.com