

ORIGINAL INSTRUCTIONS - according to Directive 2006/42/EC, Annex I 1.7.4.1

OPERATOR'S MANUAL

TD65F

TD75F

TD85F

Tractor

Part number 47518904

2nd edition English

July 2013

Replaces part number 84210365



SECTION SUMMARY

1 – General Information and Safety

2 – Controls, Instruments and Operation

3 – Field Operation

4 – Lubrication and Maintenance

5 – Fault Finding

6 – Vehicle Storage

7 – Accessories

8 – Specifications

9 – First 50–Hour Service Forms

10 – Index

Electro-magnetic Interference (EMC)

This tractor complies strictly with the European Regulations on electro-magnetic emissions. However, interference may arise as a result of add-on equipment which may not necessarily meet the required standards. As such interference can result in serious malfunction of the unit and/or create unsafe situations, you must observe the following:

- Ensure that each piece of non-New Holland equipment fitted to the tractor bears the CE mark.



- The maximum power of emission equipment (radio, telephones, etc.) must not exceed the limits imposed by the national authorities of the country where you use the tractor.
- The electro-magnetic field generated by the add-on system should not exceed 24 V/m at any time and at any location in the proximity of electronic components.

Failure to comply with these rules will render the New Holland warranty null and void.

CONTENTS

Title	Page
Section 1 – General Information and Safety	
To the owner	1-1
Tractor identification	1-2
Ecology and the environment	1-3
Safety precautions	1-4
Safety decals	1-10
International symbols	1-14
Section 2 – Controls, Instruments and Operation	
Safety covers and guards	2-2
Controls and instruments	2-4
Instrument panel	2-5
Instrument console controls	2-11
Right-hand side operating controls	2-12
Left-hand side operating controls	2-13
Seats	2-15
Transmission with range gear and shuttle	2-17
Transmission with creeper and shuttle	2-20
Towing the tractor	2-28
Loading the tractor onto a transporter	2-28
Checks before using the tractor	2-29
Section 3 – Field Operation	
Starting the engine with thermostart	3-3
Power take-off	3-5
Hydraulic lift	3-18
Three-point linkage Cat. II	3-23
Remote control valves	3-27
Wheel track adjustment	3-31
Tyres	3-36
Tyre combinations	3-39
Ballasting	3-41
Static weight distribution	3-46

Section 4 – Lubrication and Maintenance

Access for inspection and maintenance	4–5
Lubrication and maintenance table	4–5
Flexible maintenance	4–8
When the warning light is on	4–10
10–hour / daily service	4–15
50–hour service	4–16
300–hour service	4–19
900–hour service	4–25
1200–hour service	4–25
1200–hour or every 2 years service	4–26
General maintenance	4–30
Electrical system	4–32
Recommendations for bodywork maintenance	4–37
Lubricant capacities and specifications	4–38

Section 5 – Fault Finding

Introduction	5–1
Engine	5–2
Electrical system	5–5
Hydraulic system	5–6
Three-point linkage	5–7
Brakes	5–8
Cab	5–8

Section 6 – Vehicle Storage

6–1

Section 7 – Accessories

Beacon lamp	7–2
Drawbars and towing attachments	7–3

Section 8 – Specifications

General Dimensions	8–2
Weights	8–3
Engine specifications	8–5
Timing	8–6
Fuel system	8–6
Lubrication	8–7
Cooling system	8–7
Transmission	8–7
Power take-off	8–8
Hydraulic system	8–8
Three-point linkage	8–9
Front axle	8–9
Steering	8–10
4WD front axle	8–10
Brakes	8–11
Bodywork and driving position	8–11
Towing devices	8–11
Electrical system	8–12

Section 9 – First 50–hour Service Forms

9–1

Section 10 – Index

10–1

SECTION 1

GENERAL INFORMATION AND SAFETY

TO THE OWNER

GENERAL

This Manual has been prepared to assist you in the correct procedure for running-in, driving and operating and for the maintenance of your new tractor. Read this Manual carefully. Your tractor is intended for use in normal and customary agricultural applications.

If at any time you require advice concerning your tractor, do not hesitate to contact your New Holland dealer. He has factory trained personnel, genuine manufacturers' parts and the necessary equipment to carry out all your service requirements.

Your tractor has been designed and built to give maximum performance, economy and ease of operation under a wide variety of operating conditions. Prior to delivery, the tractor was carefully inspected, both at the factory and by your dealer to ensure that it reaches you in optimum condition. To maintain this condition and ensure trouble-free operation, it is important that the routine services, as specified in Section 4 of this Manual, are carried out at the recommended intervals.

CLEANING THE TRACTOR

Your tractor is a state-of-the-art machine with sophisticated controls. This should be borne in mind when cleaning the tractor, particularly if using a high pressure washer. Even though every precaution has been taken to safeguard electrical components and connections, the pressure generated by some of these machines is such that complete protection against water ingress cannot be guaranteed.

When using a high pressure washer, do not stand too close to the tractor and avoid directing the jet at electronic components, electrical connections, breathers, seals, filler caps, etc. Never direct a cold water jet at a hot engine or exhaust.

SAFETY

Pages 1-4 to 1-9 inclusive list the precautions to be observed to ensure your safety and the safety of others. Read the safety precautions and follow the advice offered **before** operating the tractor.

FIRST 50 HOUR SERVICE

In Section 9, at the back of this Manual, you will find the 50-hour service reports.

After you have operated the tractor for 50 hours, take your tractor, together with this Manual, to your dealer. He will then perform the factory recommended 50-hour service and complete the service report sheets (pages 9-1 and 9-3). The first sheet (page 9-1) is the dealer's copy and should be removed by the dealer after the service has been carried out. The second sheet (page 9-3) is your copy of the service performed. **Ensure that you and the dealer sign both copies.**

SERVICE PARTS

It should be pointed out that genuine parts have been examined and approved by the Company. The installation and/or use of 'non-genuine' products could have negative effects upon the design characteristics of your tractor and thereby affect its safety. The Company is not liable for any damage caused by the use of 'non-genuine' parts and accessories. Only genuine replacement parts should be used. The use of non-genuine parts may invalidate legal approvals associated with this product.

It is prohibited to carry out any modifications to the tractor unless specifically authorised, in writing, by the After Sales Service department of the Company.

WARRANTY

Your tractor is warranted according to legal rights in your country and the contractual agreement with the selling dealer. No warranty shall, however, apply if the tractor has not been used, adjusted and maintained according to the instructions given in the Operator's Manual.

TRACTOR IDENTIFICATION

Serial numbers identify the tractor and its main components. The identification data must be supplied by the dealer for requests for spare parts or service operations. Identification data is of fundamental importance in the event of theft of the tractor. The location of the various identification data is shown below.

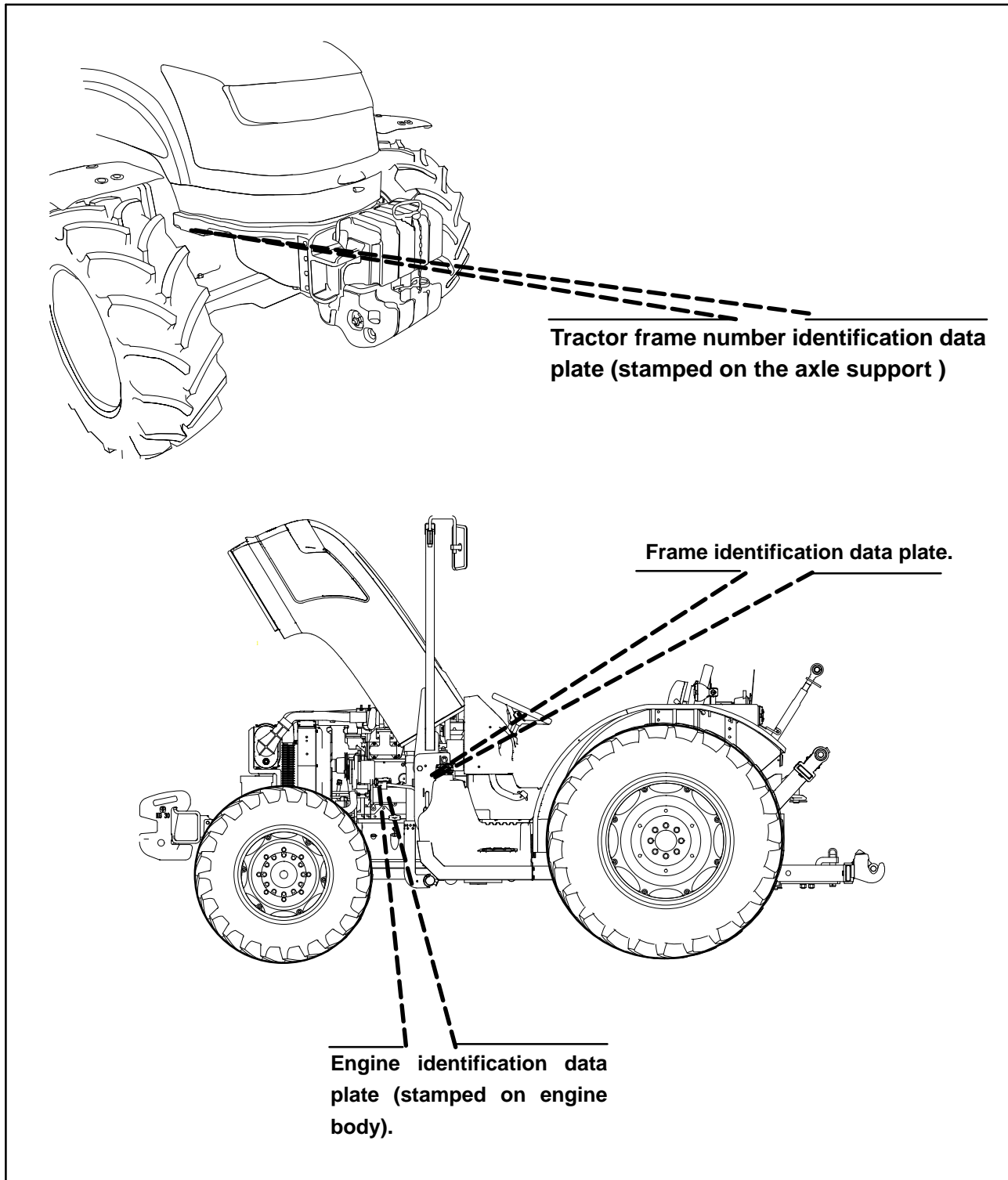

ECOLOGY AND THE ENVIRONMENT

Soil, air and water are vital factors of agriculture and life in general. Where legislation does not yet rule the treatment of some of the substances which are required by advanced technology, common sense should govern the use and disposal of products of a chemical and petrochemical nature.

The following are recommendations which may be of assistance:

- Become acquainted with and ensure that you understand the relative legislation applicable to your country.
- Where no legislation exists, obtain information from suppliers of oils, filters, batteries, fuels, antifreeze, cleaning agents, etc., with regard to their effect on man and nature and how to safely store, use and dispose of these substances. Agricultural consultants will, in many cases, be able to help you as well.

HELPFUL HINTS

1. Avoid filling tanks using unsuitable containers or inappropriate pressurised fuel delivery systems which may cause considerable spillage.
2. In general, avoid skin contact with all fuels, oils, acids, solvents, etc. Most of them contain substances which can be harmful to your health.

3. Modern oils contain additives. Do not burn contaminated fuels and/or waste oils in ordinary heating systems.
4. Avoid spillage when draining off used engine coolant mixtures, engine, gearbox and hydraulic oils, brake fluids, etc. Do not mix drained brake fluids or fuels with lubricants. Store them safely until they can be disposed of in a proper way to comply with local legislation and available resources.
5. Modern coolant mixtures, i.e. antifreeze and other additives, should be replaced every two years. They should not be allowed to get into the soil but should be collected and disposed of safely.
6. Do not open the air-conditioning system yourself. It contains gases which should not be released into the atmosphere. Your dealer or air conditioning specialist has a special extractor for this purpose and will have to recharge the system anyway.
7. Repair any leaks or defects in the engine cooling or hydraulic system immediately.
8. Do not increase the pressure in a pressurised circuit as this may lead to the components exploding.
9. Protect hoses during welding as penetrating weld splatter may burn a hole or weaken them, causing the loss of oils, coolant, etc.

SAFETY PRECAUTIONS

A careful operator is the best operator. Most accidents can be avoided by observing certain precautions. To help prevent accidents, read and take the following precautions **before** driving, operating or servicing the tractor. Equipment should be operated only by those who are responsible and instructed to do so.

PRECAUTIONARY STATEMENTS

Throughout this Manual you will see text, preceded by the words **NOTE**, **ATTENTION**, **IMPORTANT**, **CAUTION**, **WARNING** or **DANGER**. Such text has the following significance:

MACHINE SAFETY

NOTE: This text stresses a correct operating technique or procedure.

ATTENTION: This text warns the operator of potential machine damage if a certain procedure is not followed.

IMPORTANT: This text informs the reader of something that he needs to know to prevent minor machine damage if a certain procedure is not followed.

PERSONAL SAFETY



The word **CAUTION** is used where a safe behavioural practice, according to operating and maintenance instructions and common safety practices will protect the operator and others from accident involvement.



The word **WARNING** denotes a potential or hidden hazard which could possibly cause serious injury. It is used to warn operators and others to exercise due care and attention to avoid a surprise accident with machinery.



The word **DANGER** denotes a forbidden practice in connection with a serious hazard.

Failure to follow the **CAUTION**, **WARNING** and **DANGER** instructions may result in serious bodily injury or even death.

THE TRACTOR

1. Read the Operator's Manual carefully before using the tractor. Lack of operating knowledge can lead to accidents.
2. Only allow properly trained and qualified persons to operate the tractor.
3. To prevent falls, use the handrails and step plates when getting on and off the tractor. Keep steps and platform clear of mud and debris.
4. Replace all missing, illegible or damaged safety decals.
5. Keep safety decals free of dirt or grime.



6. Do not permit anyone but the operator to ride on the tractor unless a passenger seat is fitted. There is no safe place for extra passengers otherwise.
7. Keep children away from the tractor and farm machinery at all times.
8. Do not modify or alter or permit anyone else to modify or alter the tractor or any of its components or any tractor function without first consulting your dealer.
9. Install all guards before starting the engine or operating the tractor.

DRIVING THE TRACTOR

1. Always sit in the driver's seat while starting or driving the tractor.
2. When driving on public roads, have consideration for other road users. Pull in to the side of the road occasionally to allow any following traffic to pass. Do not exceed the legal speed limit set in your country for agricultural tractors.
3. Use a rotating beacon when driving on public roads to indicate that the vehicle is slow moving and is a possible hazard.
4. Dip the tractor lights when meeting a vehicle at night. Make sure the lights are adjusted to prevent blinding the driver of an oncoming vehicle.
5. Reduce speed before turning or applying the brakes. Brake both wheels simultaneously when making an emergency stop. Ensure that both brake pedals are locked together when travelling at road speeds or when on public roads to ensure correct operation of trailer brakes, balanced operation of the tractor brakes and four wheel braking (4WD tractors only).



6. Use extreme caution and avoid hard application of the tractor brakes when towing heavy loads at road speeds.

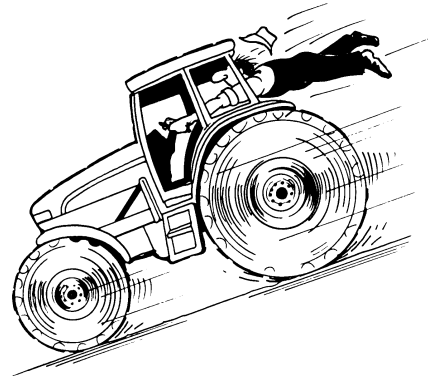

7. Keep the tractor in the same gear when going downhill as would be used when going uphill. Do not coast or freewheel down hills.
8. For safe operation any towed vehicle whose total weight exceeds that of the towing tractor must be equipped with a braking system that complies with the legal requirements of that country.
9. Never apply the differential lock when turning. When engaged, the differential lock will prevent the tractor from turning.
10. Always check overhead clearance, especially when transporting the tractor. Watch where you are going, especially at row ends, on roads and around trees and low overhanging obstacles.
11. To avoid overturns, drive the tractor with care and at speeds compatible with safety, especially when operating over rough ground, when crossing ditches or slopes and when turning corners.

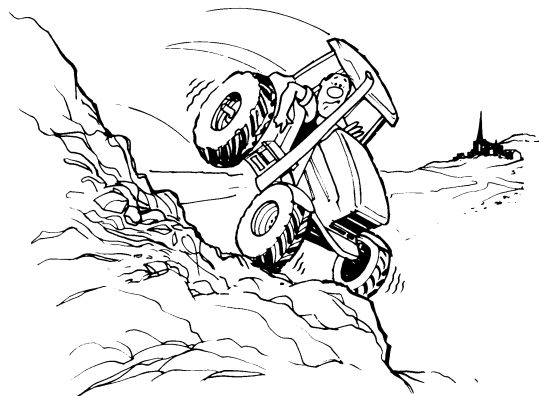

12. Use extreme caution when operating on steep slopes.
13. If the tractor becomes stuck or the tyres are frozen to the ground, reverse the tractor out to prevent overturning.

OPERATING THE TRACTOR

1. Apply the parking brake, place the P.T.O. control in the 'OFF' position, the lift control lever in the down position, the remote control valve levers in the neutral position and the transmission levers in neutral before starting the tractor.
2. Do not start the engine or operate controls (other than externally located hydraulic lift or P.T.O. switches, if fitted) while standing beside the tractor. Always sit in the tractor seat when starting the engine or operating the controls.
3. Do not bypass the transmission and P.T.O. neutral start switches. Consult your authorised dealer if your neutral start controls malfunction. Use jump leads only in the recommended manner. Improper use can result in a tractor runaway.



4. Avoid accidental contact with the gear shift levers while the engine is running. Unexpected tractor movement can result from such contact.
5. Do not get off the tractor while it is in motion.
6. If the power steering or engine ceases operating, stop the tractor immediately as the tractor will be more difficult to control.
7. Before leaving the tractor, park the tractor on level ground, apply the parking brake, lower attached implements to the ground, disengage the P.T.O. and stop the engine.

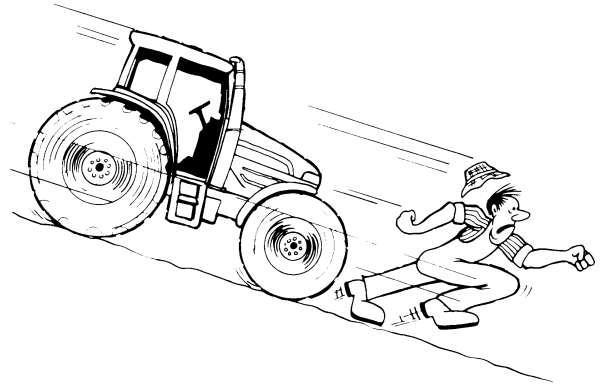

8. Do not park the tractor on a steep incline.
9. The cab is designed to provide the minimum noise level at the operator's ears and meets or exceeds applicable standards in this respect. However, noise (sound pressure level) in the workplace can exceed 85 dB(A) when working between buildings or in confined spaces, with cab windows open. Therefore, it is recommended that operators wear suitable ear protectors when operating in high noise level conditions.

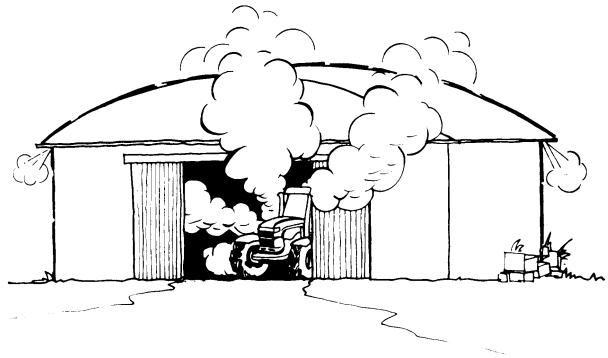

10. Do not run the tractor engine in an enclosed building without adequate ventilation. Exhaust fumes are toxic and can cause death.
11. Pull only from the pick-up hitch, swinging drawbar or the lower link drawbar in the lowered position. Use only a drawbar pin that locks in place. Pulling from the tractor rear axle or any point above the axle may cause the tractor to overturn.

12. Always select Position Control when attaching equipment and when transporting equipment. Be sure hydraulic couplers are properly mounted and will disconnect safely in case of accidental detachment of the implement.

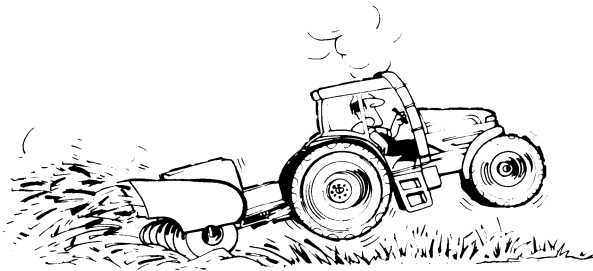

13. If the front end of the tractor tends to rise when heavy implements are attached to the three-point hitch, install front end or front wheel weights. Do not operate the tractor with a light front end.
14. Engage the clutch slowly when driving out of a ditch, gully or up a steep hillside. Disengage the clutch promptly if the front wheels rise off the ground.
15. Ensure any attached equipment or accessories are correctly installed, are approved for use with the tractor, do not overload the tractor and are operated and maintained in accordance with the instructions issued by the equipment or accessory manufacturer.
16. Remember that your tractor, if abused or incorrectly used, can be dangerous and become a hazard both to the operator and to bystanders. Do not overload or operate with attached equipment which is unsafe, not designed for the particular task or is poorly maintained.
17. Do not leave equipment in the raised position when the vehicle is stopped or unattended.
18. Do not drive equipment near open fires.
19. Always wear a protective mask when working with toxic spray chemicals. Follow the directions on the chemical container.

OPERATING THE P.T.O.

1. When operating PTO-driven equipment, shut off the engine, switch off the PTO and wait until the PTO stops before getting off the tractor and disconnecting the equipment.

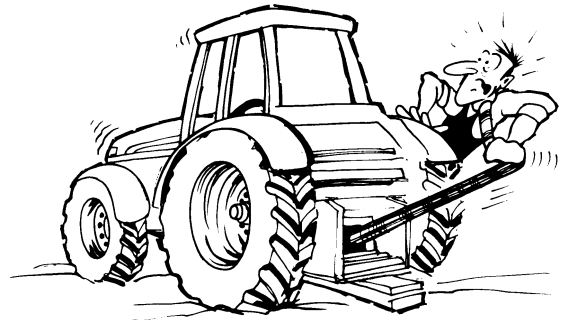

2. Do not wear loose clothing when operating the power take-off or especially when near rotating equipment.
3. When operating stationary PTO-driven equipment, always apply the tractor parking brake and block the rear wheels front and back.



4. To avoid injury, do not clean, adjust, unclog or service PTO driven equipment when the tractor engine is running. Ensure that the PTO is switched off.
5. Make sure the PTO guard is in position at all times and always replace the PTO cap when the PTO is not in use.

SERVICING THE TRACTOR



1. The cooling system operates under pressure which is controlled by the expansion tank cap. It is dangerous to remove the cap while the system is hot. Always turn the cap slowly to the first stop and allow the pressure to escape before removing the cap entirely. Never remove the cap from the top of the radiator unless the expansion tank pressure cap has first been removed.
2. Do not smoke while refuelling the tractor. Keep any type of open flame away.
3. Keep the tractor and equipment, particularly brakes and steering, maintained in a reliable and satisfactory condition to ensure your safety and comply with legal requirements.
4. To prevent fire or explosion, keep open flames away from battery or cold weather starting aids. To prevent sparks which could cause explosion, use jumper cables according to instructions.
5. Do not attempt to service the air conditioning system. It is possible to be severely frost bitten or injured by escaping refrigerant. Special equipment and instruments are required to service the air conditioning system. See your authorised dealer for service.
6. Stop the engine before performing any service on the tractor.
7. Hydraulic fluid and fuel oil in the injection system operate under high pressure. Escaping hydraulic fluid or fuel oil under pressure can penetrate the skin causing serious injury.

Unqualified persons should not remove or attempt to adjust a pump, injector, nozzle or any other part of the fuel injection or hydraulic systems. Failure to follow these instructions can result in serious injury.

- Do **not** use your hand to check for leaks. Use a piece of cardboard or paper to search for leaks.
- Stop the engine and relieve pressure before connecting or disconnecting lines.

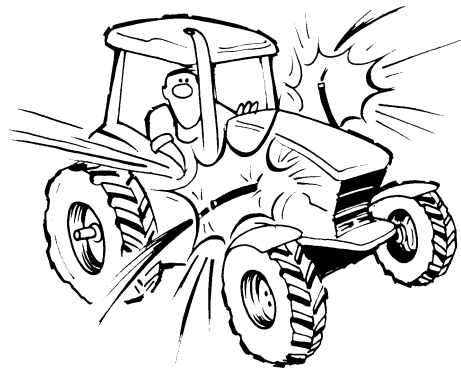

- Tighten all connections before starting the engine or pressurising lines.
 - If fluid is injected into the skin obtain medical attention immediately or gangrene may result.
8. Do not modify or alter or permit anyone else to modify or alter the tractor or any of its components or any tractor function without first consulting an authorised dealer.
 9. Continuous long term contact with used engine oil may cause skin cancer. Avoid prolonged contact with used engine oil. Wash skin promptly with soap and water.
 10. Keep equipment clean and properly maintained.
 11. Dispose of all drained fluids and removed filters properly.
 12. Tractor wheels are very heavy. Handle with care and ensure, when stored, that they can not topple and cause injury.

Thank you so much for reading.
Please click the “Buy Now!”
button below to download the
complete manual.



After you pay.

You can download the most
perfect and complete manual in
the world immediately.

Our support email:

ebooklibonline@outlook.com