

m-3599

NEW HOLLAND

38" Side Discharge Mower

For
LS Yard Tractors
Model No.
715697001 – T0H0001 & Up

OPERATOR'S MANUAL



Introduction

Thank you for purchasing a New Holland product.

All of us at New Holland want you to be completely satisfied with your new product, so feel free to contact your local Authorized Service Dealer for help with service, genuine replacement parts, or other information you may require.

Whenever you contact your Authorized Service Dealer or the factory, always know the model and serial numbers of your product. These numbers will help the Service Dealer or Service Representative provide exact information about your specific product. You will find the model and serial number plate located in a unique place on the product as shown below.

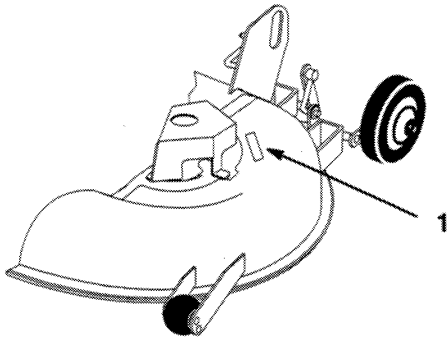

1222

1. Model and Serial Number Plate

For your convenience, write the product model and serial numbers in the space below.

 NEW HOLLAND	
MODEL NO.	SERIAL NO.
COMPONENT	
NEW HOLLAND NORTH AMERICA, INC.	
<small>MADE IN U.S.A.</small>	

The warning system in this manual identifies potential hazards and has special safety messages that help you and others avoid personal injury, even death. DANGER, WARNING and CAUTION are signal words used to identify the level of hazard. However, regardless of the hazard, be extremely careful.

DANGER signals an extreme hazard that will cause serious injury or death if the recommended precautions are not followed.

WARNING signals a hazard that may cause serious injury or death if the recommended precautions are not followed.

CAUTION signals a hazard that may cause minor or moderate injury if the recommended precautions are not followed.

Two other words are also used to highlight information. "Important" calls attention to special mechanical information and "Note" emphasizes general information worthy of special attention.

The left and right side of the machine is determined by sitting on the seat in the normal operator's position.

Contents

	Page		Page
Safety and Instruction Decals	2	Attachment Power Lift	12
Assembly	3	Attachment Lift Lever	12
Loose Parts	3	Adjusting Dial-A-Height	13
Installing Discharge Chute and Tension Spring	4	Adjusting Anti-Scalp Rollers	13
Installing Discharge Cover (Mulching Model(s) Only)	5	Tips for Mowing and Mulching Grass	14
Installing the Mower	5	Maintenance	15
Transport Height Adjustment	7	Service Interval Chart	15
Side-to-Side Mower Leveling	7	Cutting Blade	16
Front-to-Rear Blade Slope	9	Greasing and Lubrication	18
Removing the Mower	10	Blade Drive Belt	18
Operation	11	Washing Underside of Mower	19
Side Discharge or Mulching Grass	11	Storage	20
Operating the Power Take Off (PTO)	11	Troubleshooting	21

Safety and Instruction Decals



Safety decals and instructions are easily visible to the operator and are located near any area of potential danger. Replace any decal that is damaged or lost.

ON MOWER LEFT SIDE
(Part No. TR92D7110)

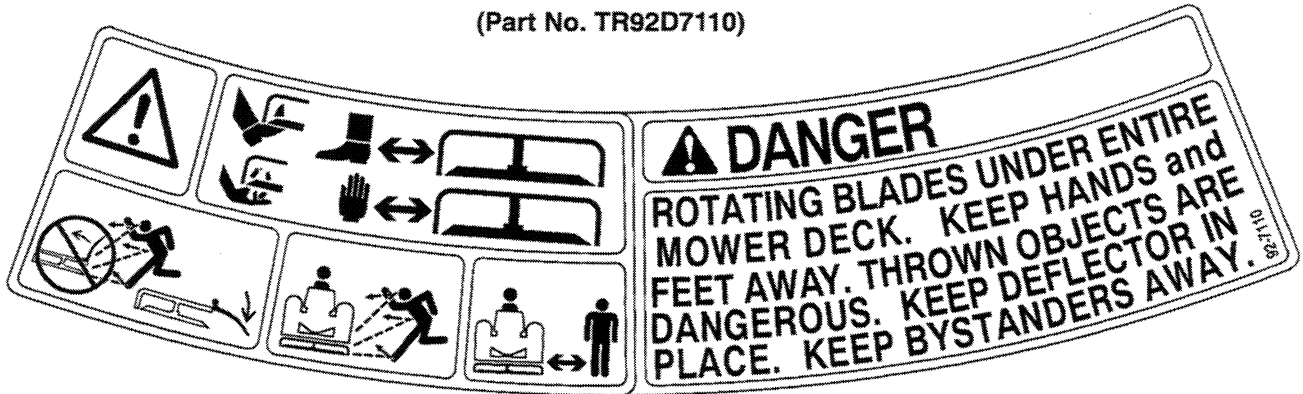

UNDER GRASS DEFLECTOR
(Part No. TR92D7109)

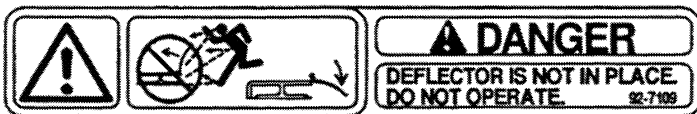

ON MOWER CENTER
(Part No. TR117137)

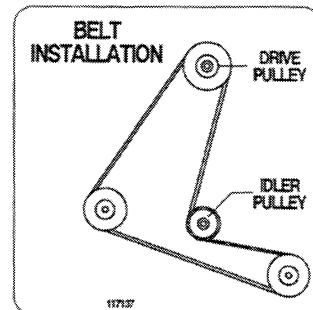

ON GRASS DEFLECTOR
AND ON
MOWER RIGHT SIDE
(Part No. TR93D1122)



Assembly

Loose Parts

Note: Use the chart below to identify parts used for assembly.

DESCRIPTION	QTY.	USE
Grass deflector	1	Install grass deflector and tension spring
Torsion spring	1	
Rod	1	
Stand-off-long	1	
Nut (3/8")	1	
Tension spring	1	
Hairpin cotter (3-3/8")	2	Install mower to tractor
Washer (3/4")	2	
Rear link	1	Install rear link
Washer (3/8")	3	
Cotter pin (1")	1	
Hairpin cotter (2-9/16")	2	
Adjustable link	1	Install adjustable link
Washer (3/8")	2	
Hairpin cotter (2-9/16")	1	
Cotter pin (1")	1	
V-belt	1	Install mower drive belt
Operator's Manual	1	Read before operating

Installing Grass Deflector and Tension Spring

1. Locate items shown in Fig. 1.
2. Slide rod, non-rib end, through rear grass deflector bracket.
3. Place spring on rod, with end wires down, between grass deflector brackets, and slide rod through second grass deflector bracket.
4. Insert rod at front of grass deflector into short stand-off on deck. Secure rear end of rod to deck with long stand-off and nut (Fig. 1).

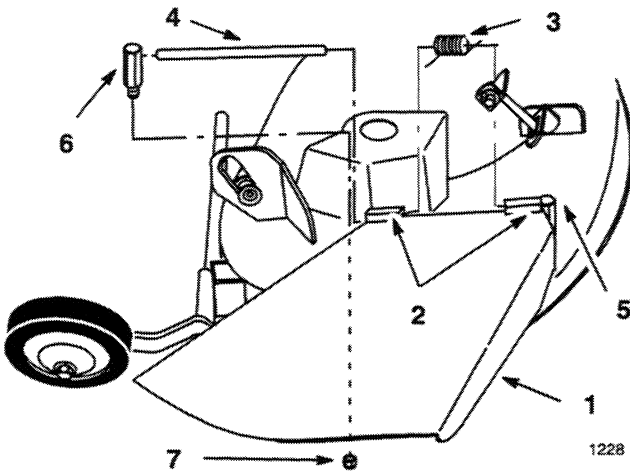

Figure 1

- | | |
|--------------------|--------------------|
| 1. Grass deflector | 5. Short stand-off |
| 2. Bracket | 6. Long stand-off |
| 3. Spring | 7. Nut (3/8") |
| 4. Rod | |

IMPORTANT: Grass deflector must be spring loaded in the down position. Lift deflector up to test that it snaps to the full down position.

DANGER

POTENTIAL HAZARD

- Without the grass deflector, discharge cover, or a complete grass catcher mounted in place, you and others are exposed to blade contact and thrown debris.

WHAT CAN HAPPEN

- Contact with rotating mower blade(s) and thrown debris will cause injury or death.

HOW TO AVOID THE HAZARD

- NEVER remove the grass deflector from the mower because the grass deflector routes material down toward the turf. If the grass deflector is ever damaged, replace it immediately.
- Never put your hands or feet under the mower.
- Never try to clear discharge area or mower blades unless you move the power take off (PTO) to "OFF" and rotate the ignition key to "OFF." Also remove the key and pull the wire off the spark plug(s).

5. Hook the tension spring onto the idler arm and the bolt by the belt cover (Fig. 2).

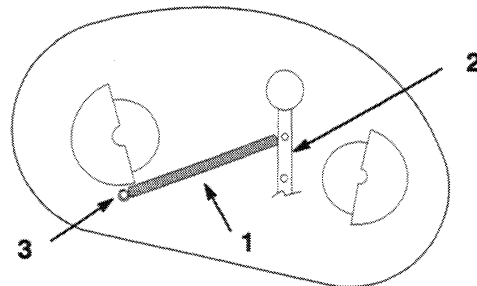

Figure 2

- | | |
|-------------------|---------|
| 1. Tension spring | 3. Bolt |
| 2. Idler | |

Thank you so much for reading.
Please click the “Buy Now!”
button below to download the
complete manual.



After you pay.

You can download the most
perfect and complete manual in
the world immediately.

Our support email:

ebooklibonline@outlook.com