

NEW HOLLAND

LS35-15H

Yard Tractor

Model No.
715692016 – T1B0001 & Up

OPERATOR'S

MANUAL



NEW HOLLAND

SERVICE

Contents

	Page		Page
Safety	3	Battery	28
Safe Operating Practices	3	Wiring Diagram	31
Riding Mower Safety	5	Cleaning and Storage	32
Slope Chart	7	Troubleshooting	33
Safety and Instruction Decals	9		
Gasoline and Oil	11		
Recommended Gasoline	11		
Stabilizer/Conditioner	11		
Filling the Fuel Tank	11		
Check Engine Oil Level	11		
Operation	12		
Think Safety First	12		
Controls	12		
Parking Brake	12		
Starting and Stopping the Engine	12		
Operating the Power Take Off (PTO)	13		
The Safety Interlock System	13		
Indicator Control Module	15		
Driving Forward or Backward	16		
Stopping the Machine	16		
Attachment Lift Lever	16		
Adjusting Dial-A-Height	17		
Positioning the Seat	17		
Headlights	17		
Positioning the Tilt Steering Wheel	17		
Using the Cruise Control	17		
Pushing the Machine by Hand	18		
Maintenance	19		
Recommended Maintenance Schedule	19		
Air Cleaner	20		
Engine Oil	21		
Spark Plug	22		
Greasing and Lubrication	23		
Tire Pressure	24		
Brake	24		
Fuel Tank	25		
Fuel Filter	25		
Front Wheel Toe-In	26		
Transaxle Fluid	27		
Fuse	27		
Headlights	27		

Warning

The engine exhaust from this product contains chemicals known to the State of California to cause cancer, birth defects, or other reproductive harm.

Important The engine in this product is not equipped with a spark arrester muffler. It is a violation of California Public Resource Code Section 4442 to use or operate this engine on any forest-covered, brush-covered, or grass-covered land as defined in CPRC 4126. Other states or federal areas may have similar laws.

The enclosed Engine Owner's Manual is supplied for information regarding The U.S. Environmental Protection Agency (EPA) and the California Emission Control Regulation of emission systems, maintenance and warranty.

Keep this engine Owner's Manual with your unit. Should this engine Owner's Manual become damaged or illegible, replace immediately. Replacements may be ordered through the engine manufacturer.

This spark ignition system complies with Canadian ICES-002.

Ce système d'allumage par étincelle de véhicule est conforme à la norme NMB-002 du Canada.

Introduction

Thank you for purchasing a New Holland product.

All of us at New Holland want you to be completely satisfied with your new product, so feel free to contact your local Authorized Service Dealer for help with service, genuine replacement parts, or other information you may require.

Whenever you contact your Authorized Service Dealer or the factory, always know the model and serial numbers of your product. These numbers will help the Service Dealer

or Service Representative provide exact information about your specific product. You will find the model and serial number plate at the location shown in Figure 1.

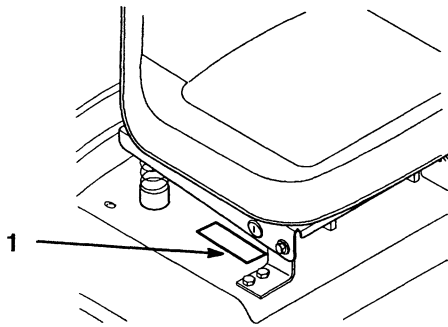

m-4220

Figure 1

1. Model and serial number plate

For your convenience, write the product model and serial numbers in the space below.

Model No: _____
Serial No. _____

Read this manual carefully to learn how to operate and maintain your product correctly. Reading this manual will help you and others avoid personal injury and damage to the product. Although we design, produce and market safe, state-of-the-art products, you are responsible for using the product properly and safely. You are also responsible for training persons, who you allow to use the product, about safe operation.

The warning system in this manual identifies potential hazards and has special safety messages that help you and others avoid personal injury, even death. **Danger**, **Warning**, and **Caution** are signal words used to identify the level of hazard. However, regardless of the hazard, be extremely careful.

Danger signals an extreme hazard that will cause serious injury or death if the recommended precautions are not followed.

Warning signals a hazard that may cause serious injury or death if the recommended precautions are not followed.

Caution signals a hazard that may cause minor or moderate injury if the recommended precautions are not followed.

Two other words are also used to highlight information. **Important** calls attention to special mechanical information, and **Note** emphasizes general information worthy of special attention.

Determine the left and right side of the machine from the normal operating position.

Safety

This machine meets or exceeds the B71.1-1998 specifications of the American National Standards Institute, in effect at the time of production. However, improper use or maintenance by the operator or owner can result in injury. To reduce the potential for injury, comply with these safety instructions and always pay attention to the safety alert **▲** symbol, which means CAUTION, WARNING, or DANGER—"personal safety instruction." Failure to comply with the instruction may result in personal injury or death.

Safe Operating Practices

The following instructions are from ANSI standard B71.1—1998.

This product is capable of amputating hands and feet and throwing objects. Always follow all safety instructions to avoid serious injury or death.

General Operation

- Read, understand, and follow all instructions in the operator's manual and on the machine before starting.
- Allow only responsible adults who are familiar with the instructions to operate the machine.
- Clear the area of objects such as rocks, toys, wire, etc., which could be picked up and thrown by the blade.
- Be sure the area is clear of other people before mowing. Stop the machine if anyone enters the area.
- Never carry passengers.
- Do not mow in reverse unless absolutely necessary. Always look down and behind before and while backing.
- Be aware of the mower discharge direction and do not point it at anyone. Do not operate the mower without either the entire grass catcher or the guard in place.
- Slow down before turning.
- Never leave a running machine unattended. Always turn off blades, set parking brake, stop engine, and remove keys before dismounting.
- Turn off blades when not mowing.
- Stop the engine before removing the grass catcher or unclogging the chute.
- Mow only in daylight or good artificial light.
- Do not operate the machine while under the influence of alcohol or drugs.

- Watch for traffic when operating near or crossing roadways.
- Use extra care when loading or unloading the machine into a trailer or truck.
- Always wear safety goggles or safety glasses with side shields when operating mower.
- Data indicates that operators, age 60 years and above, are involved in a large percentage of riding mower-related injuries. These operators should evaluate their ability to operate the riding mower safely enough to protect themselves and others from serious injury.

Slope Operation

Slopes are a major factor related to loss-of-control and tip-over accidents, which can result in severe injury or death. All slopes require extra caution. If you cannot back up the slope or if you feel uneasy on it, do not mow it.

- Mow up and down slopes, not across.
- Remove obstacles such as rocks, tree limbs, etc.
- Watch for holes, ruts or bumps. Uneven terrain could overturn the machine. Tall grass can hide obstacles.
- Use slow speed. Choose a low gear so that you will not have to stop or shift while on the slope.
- Follow New Holland's recommendations for wheel weight or counterweights to improve stability.
- Use extra care with grass catchers or other attachments. These can change the stability of the machine.
- Keep all movement on slopes slow and gradual. Do not make sudden changes in speed or direction.
- Avoid starting or stopping on a slope. If tires lose traction, disengage the blades and proceed slowly straight down the slope.
- Do not turn on slopes unless necessary, and then, turn slowly and gradually downhill, if possible.
- Do not mow near drop-offs, ditches, or embankments. The machine could suddenly turn over if a wheel goes over the edge of a cliff or ditch, or if an edge caves in.
- Do not mow on wet grass. Reduced traction could cause sliding.
- Do not try to stabilize the machine by putting your foot on the ground.
- Do not use a grass catcher on steep slopes.

Children

Tragic accidents can occur if the operator is not alert to the presence of children. Children are often attracted to the machine and the mowing activity. Never assume that children will remain where you last saw them.

- Keep children out of the mowing area and under the watchful care of another responsible adult.
- Be alert and turn the machine off if children enter the area.
- Before and while backing, look behind and down for small children.
- Never carry children, even with the blades off. They may fall off and be seriously injured or interfere with safe machine operation.
- Never allow children to operate the machine.
- Use extra care when approaching blind corners, shrubs, trees, the end of a fence or other objects that may obscure vision.



Service

- Use extra care when handling gasoline and other fuels. They are flammable and vapors are explosive.
 - A. Use only an approved container.
 - B. Never remove the gas cap or add fuel when the engine is running. Allow the engine to cool before refueling. Do not smoke.
 - C. Never refuel the machine indoors.
 - D. Never store the machine or fuel container inside where there is an open flame, such as near a water heater or furnace.
- Never run a machine inside a closed area.
- Keep nuts and bolts tight, especially the blade attachment bolts. Keep equipment in good condition.
- Never tamper with safety devices. Check their proper operation regularly.
- Keep the machine free of grass, leaves, or other debris build-up. Clean up oil or fuel spillage. Allow the machine to cool before storing.
- Stop and inspect the equipment if you strike an object. Repair, if necessary, before restarting.
- Grass catcher components are subject to wear, damage and deterioration, which could expose moving parts or allow objects to be thrown. Frequently check components and replace with manufacturer's recommended parts, when necessary.

- Mower blades are sharp and can cut. Wrap the blade(s) or wear gloves, and use extra caution when servicing them.
- Use only genuine New Holland replacement parts to ensure that original standards are maintained.
- If a steep slope must be ascended, back up the hill, and drive forward down the hill, keeping the machine in gear.
- Avoid turning on slopes. If you must turn, turn slowly and gradually downhill, if possible.

Riding Mower Safety

The following list contains safety information specific to our products or other safety information that you must know that is not included in the ANSI standards.

	Warning	
<p>Engine exhaust contains carbon monoxide, which is an odorless, deadly poison that can kill you. It is also known to the State of California to cause birth defects.</p> <p>Do not run engine indoors or in an enclosed area.</p>		

- Stop the engine, disconnect spark plug wire(s) and remove key before performing any service, repairs, maintenance or adjustments.
- Slow down before turning. Sharp turns on any terrain may cause loss of control.
- Never leave a running machine unattended. Always turn off blades, set parking brake, stop engine, and remove the ignition and reverse interlock keys before dismantling.
- Keep hands, feet, hair and loose clothing away from attachment discharge area, underside of mower and any moving parts while engine is running.
- Do not touch equipment or attachment parts which may be hot from operation. Allow to cool before attempting to maintain, adjust or service.
- Battery acid is poisonous and can cause burns. Avoid contact with skin, eyes and clothing. Protect your face, eyes and clothing when working with a battery.
- Battery gases can explode. Keep cigarettes, sparks and flames away from battery.
- Use only genuine replacement parts to ensure that original standards are maintained.
- Use only New Holland approved attachments. Warranty may be voided if used with unapproved attachments.
- Do not mow across slopes exceeding 5 degrees.
- Do not mow down slopes exceeding 15 degrees.
- Do not mow up slopes exceeding 10 degrees.

Slope Chart

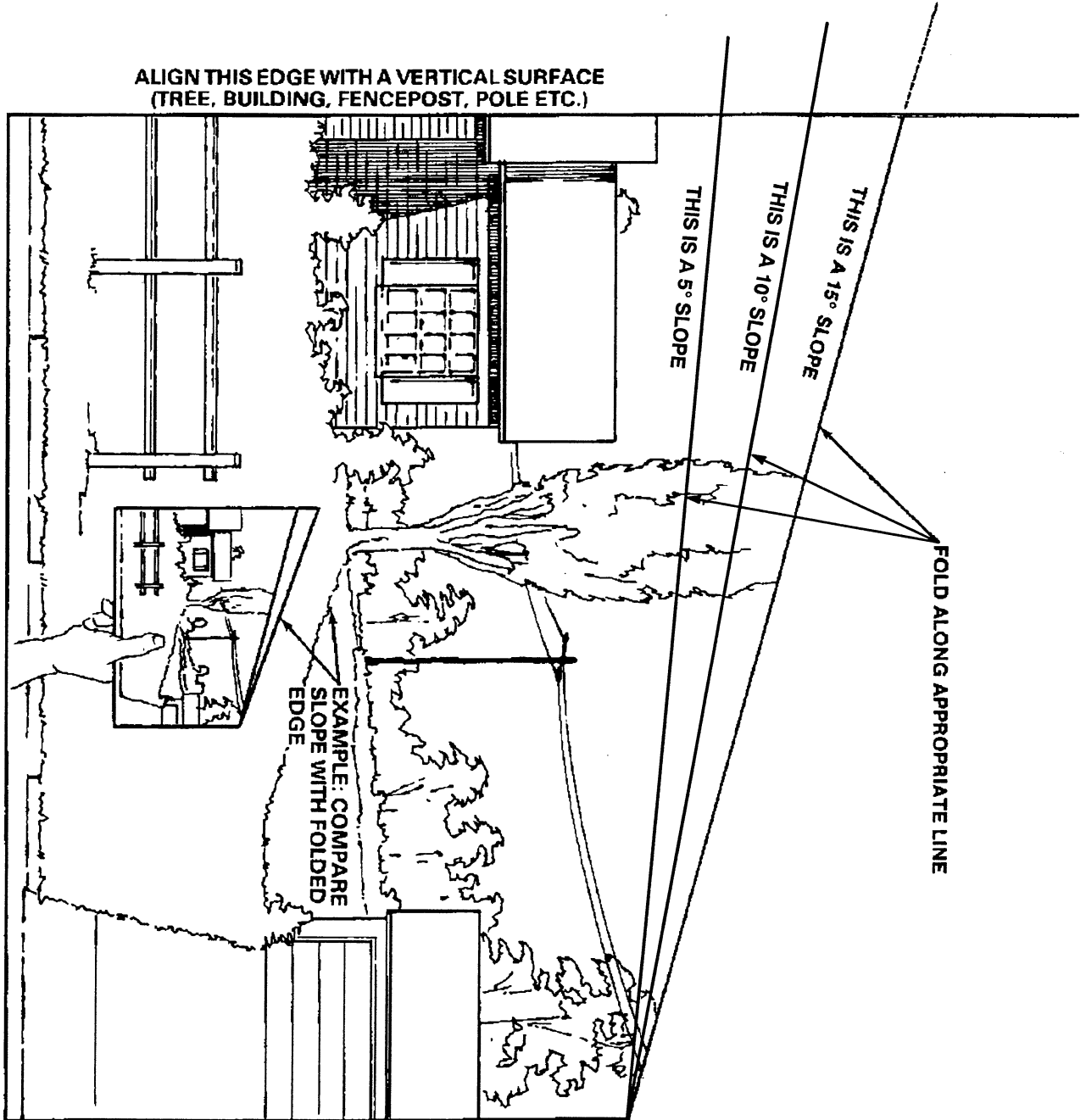

Safety and Instruction Decals



Safety decals and instructions are easily visible to the operator and are located near any area of potential danger. Replace any decal that is damaged or lost.

**On Steering Tower
(Part No. TR93D0302)**

<p>⚠ DANGER</p> <p>TO AVOID SERIOUS INJURY OR DEATH, • READ AND UNDERSTAND THE OPERATOR'S MANUAL. • KNOW LOCATION AND FUNCTION OF CONTROLS. • NEVER USE WHEN UNDER THE INFLUENCE OF ALCOHOL OR DRUGS.</p> <p>NEVER MOW STEEP HILLS OVER 10°</p> <p>• USE SAFELY; MACHINE IS NOT A TOY; NEVER LET CHILDREN OPERATE. • GO UP AND DOWN SLOPES, NOT ACROSS. • AVOID SHARP OR SUDDEN TURNS AND SLIPPERY OR STEEP AREAS. • IF MACHINE STOPS GOING UPHILL, STOP BLADE AND BACK SLOWLY DOWN.</p> <p>NEVER MOW UPHILL OVER 10°</p> <p>• NEVER MOW WHEN CHILDREN OR OTHERS ARE IN THE MOWING AREA. • NEVER CARRY CHILDREN OR OTHER PASSENGERS. • LOOK DOWN AND BEHIND BEFORE AND WHILE BACKING UP.</p> <p>NEVER MOW DOWNHILL OVER 15°</p> <p>• KEEP SAFETY DEVICES IN PLACE AND WORKING; CHECK BEFORE EACH USE. • SAFETY INTERLOCKS CAN FAIL; NEVER ASSUME BLADE IS STOPPED. • STOP ENGINE, SET PARKING BRAKE AND REMOVE KEY IF LEAVING MACHINE. • REMOVE OBJECTS THAT COULD BE THROWN BY THE BLADE.</p>	<p>HYDRO DRIVE PEDAL</p> <p>REVERSE NEUTRAL FORWARD</p> <p>BRAKE PEDAL</p> <p>PARKING BRAKE</p> <p>ON OFF</p> <p>TO SET: DEPRESS BRAKE PEDAL AND LEFT LEVER</p> <p>TO RELEASE: DEPRESS BRAKE PEDAL</p>
---	--

**On Frame Step
(Part No. TR92D8946)**

⚠ DANGER

• ROTATING BLADES CAN CUT OFF ARMS AND LEGS.
 • NEVER MOW WHEN CHILDREN ARE NEAR.
 • NEVER CARRY RIDERS; THEY FALL OFF.

**On Frame Right Rear
(Part No. TR92D6726)**

TO OPERATE TRACTOR
 MOVE LEVER FORWARD

TO PUSH TRACTOR
 LEVER MUST BE IN REARWARD POSITION

DO NOT TOW

**On Steering Tower
(Part No. TR94D1863)**

READ YOUR OPERATOR'S MANUAL FOR OPERATING AND SAFETY INSTRUCTIONS. TO GET A REPLACEMENT MANUAL, SEND MODEL AND SERIAL NUMBERS TO: NEW HOLLAND NORTH AMERICA, INC., 500 DILLER AVE., NEW HOLLAND, PA 17557.

**Dash Indicator Panel
(Part No. TR99D8038)**

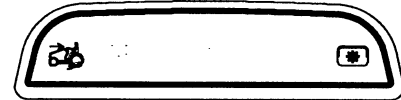

**On Seat Bracket
(Part No. TR99D2985)**

⚠ DANGER

NEVER MOW IN REVERSE IF THERE IS ANY POSSIBILITY OF CHILDREN APPEARING IN THE MOWING AREA.

**On Seat Bracket
(Part No. TR99D8894)**

TURN TO ACTIVATE IMPLEMENT DRIVE IN REVERSE

REVERSE IMPLEMENT DRIVE

**On Dash Left Side
(Part No. TR92D6738)**

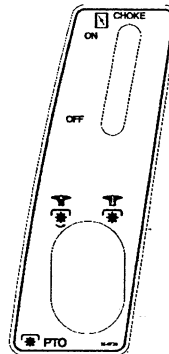

**On Dash Right Side
(Part No. TR92D6739)**

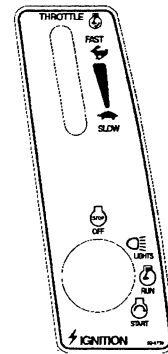

Thank you so much for reading.
Please click the “Buy Now!”
button below to download the
complete manual.



After you pay.

You can download the most
perfect and complete manual in
the world immediately.

Our support email:

ebooklibonline@outlook.com