

Product: WHEEL TRACTOR

Model: 631K WHEEL TRACTOR WT4

Configuration: 631K OEM Wheel-Tractor Scraper WT400001-UP (MACHINE) POWERED BY C18 Engine

## Disassembly and Assembly 631K OEM Power Train

Media Number -M0087696-00

Publication Date -01/11/2017

Date Updated -01/11/2017

i04351575

# Torque Converter - Disassemble - Scraper

SMCS - 3101-015

## Disassembly Procedure

Table 1

Required Tools			
Tool	Part Number	Part Description	Qty
A	138-7575	Link Brackets	3
B	1P-2420	Transmission Repair Stand	1
C	1P-0520	Driver Gp	1
D	8H-0663	Bearing Puller Gp	1
E	1P-2322	Combination Puller	1
	1P-0546	Puller Jaw	1
	1P-0510	Driver Gp	1
F	1P-0074	Slide Hammer Puller Gp	1

### Start By:

- a. Separate Torque Converter, Transmission, and Transfer Gear.
-

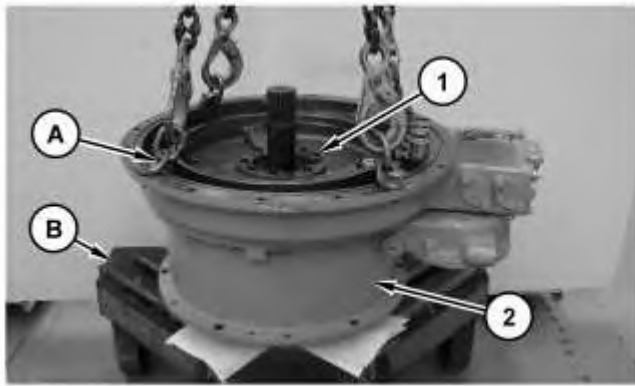

Illustration 1

g02477139

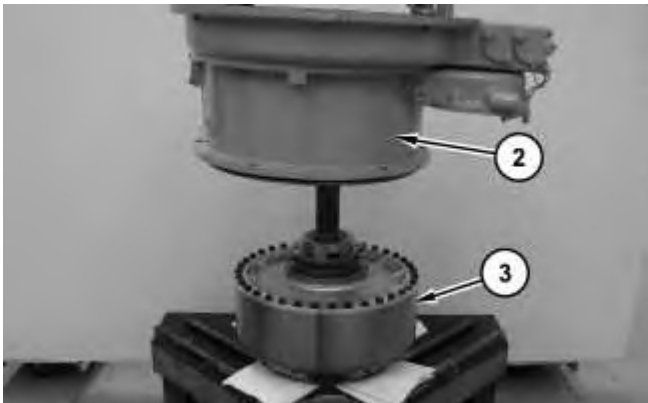

Illustration 2

g02477145

1. Attach Tooling (A) and a suitable lifting device to housing assembly (2) . Reposition housing assembly (2) onto Tooling (B). The weight of housing assembly (2) is approximately 73 kg (160 lb).
2. Remove bolts (1) and lift housing assembly (2) from torque converter assembly (3).



Illustration 3

g02477249

3. Reposition torque converter assembly (3) on Tooling (B) as shown. The weight of torque converter assembly (3) is approximately 34 kg (76 lb).

4. Remove bolts (4).

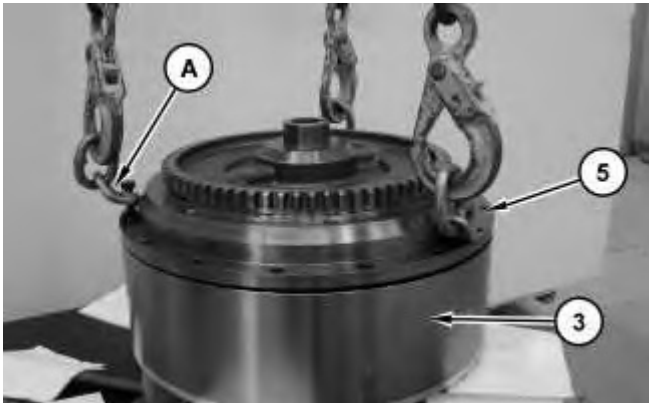

Illustration 4

g02477847

5. Attach Tooling (A) and a suitable lifting device to cover assembly (5). Remove cover assembly (5) from torque converter assembly (3).



Illustration 5

g02494878

6. Remove clutch piston (6).

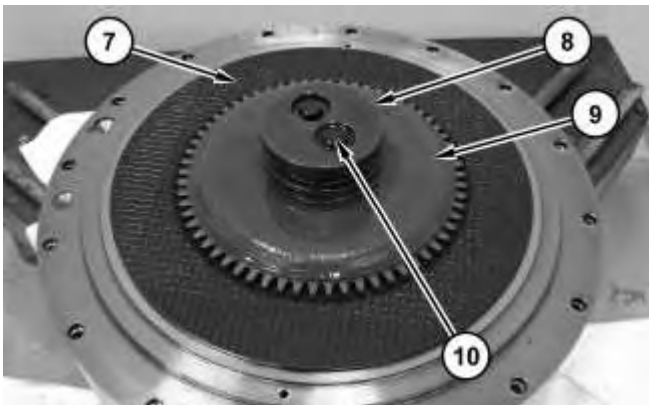

Illustration 6

g02495236

7. Remove friction disk (7). Remove bolts (10) and shaft retainer (8). Remove hub (9) and seal rings.



Illustration 7

g02487237

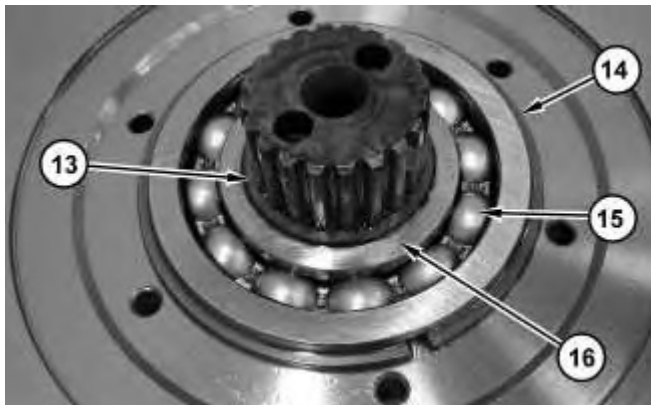

Illustration 8

g02491136

8. Remove bolts (12). Remove bearing retainer (11). Remove retaining ring (13). Remove upper bearing race (16). Remove retaining ring (14). Remove bearing (15).



Illustration 9

g02487278

9. Reposition torque converter assembly (3) on Tooling (B) as shown. The weight of torque converter assembly (3) is approximately 34 kg (76 lb).

10. Remove bolts (17).

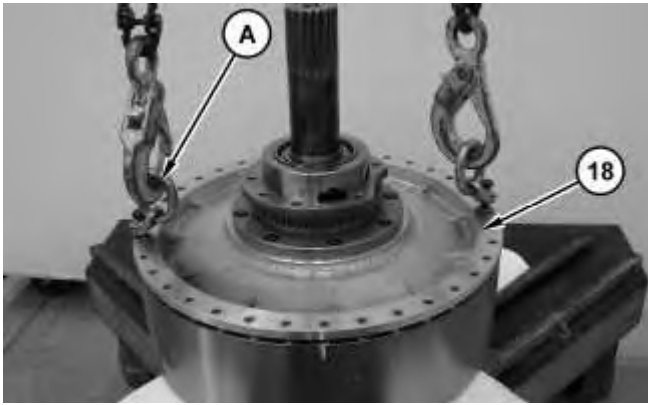

Illustration 10

g02494482

11. Attach Tooling (A) to impeller wheel assembly (18). Remove impeller wheel assembly (18). The weight of impeller wheel assembly (18) is approximately 34 kg (76 lb).

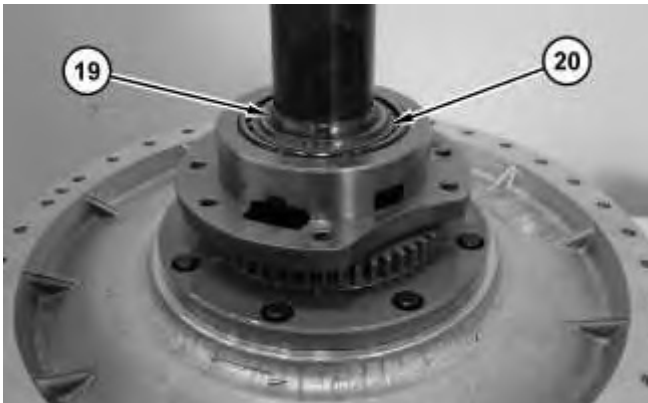

Illustration 11

g02484296

12. Remove retaining ring (19) from bearing (20).

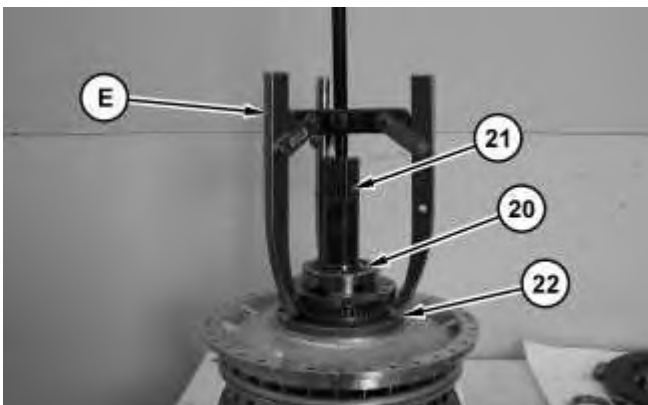

Illustration 12

g02488758

13. Use Tooling (E) to separate shaft assembly (21) from bearing assembly (20) and carrier assembly (22).

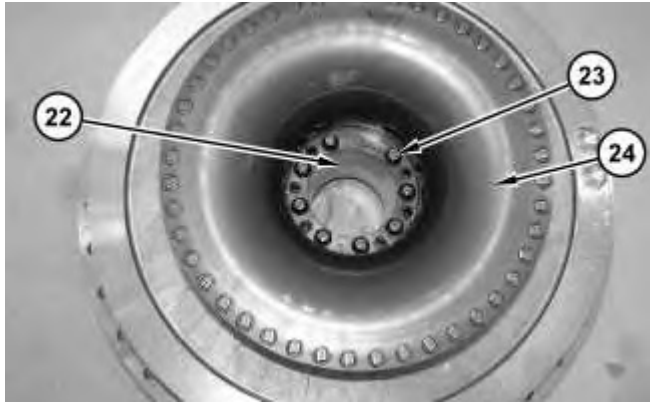

Illustration 13

g02492076

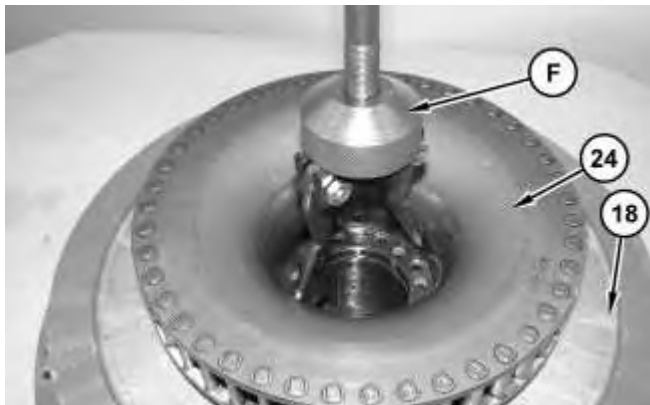

Illustration 14

g02488997

14. Remove bolts (23). Use Tooling (F) to remove stator assembly (24) from carrier assembly (22) and impeller wheel assembly (18).

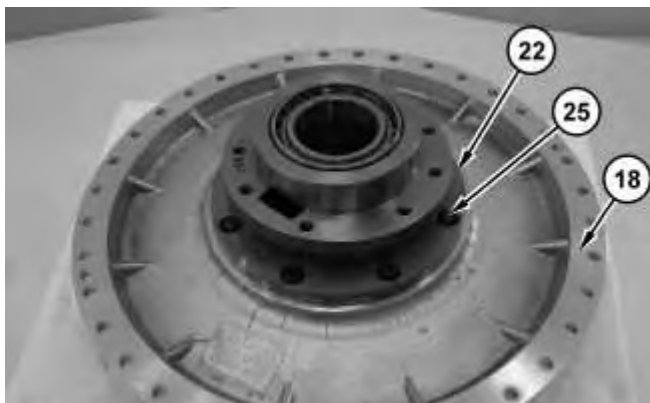

Illustration 15

g02489038

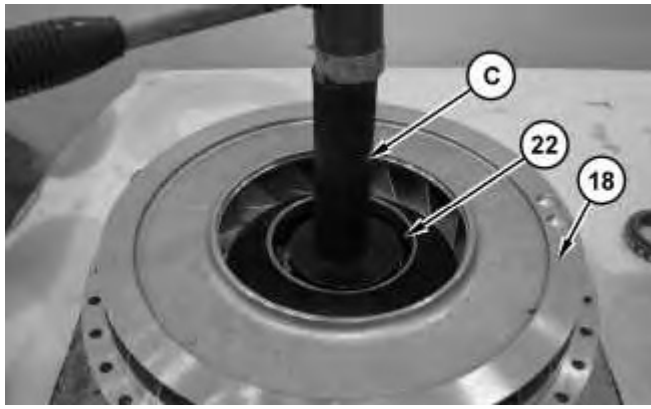

Illustration 16

g02489042

15. Remove bolts (25). Use Tooling (C) to remove carrier assembly (22) from impeller wheel assembly (18).

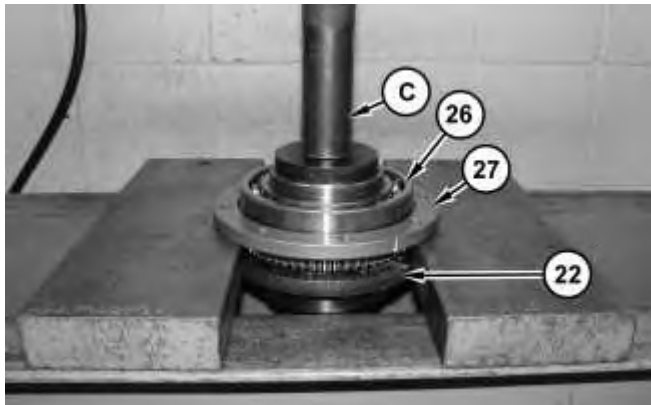

Illustration 17

g02489047

16. Using Tooling (C) and a suitable press to remove bearing (26) and gear (27) from carrier assembly (22).



Illustration 18

g02489056

17. Remove seal ring (28).

Thank you so much for reading.  
Please click the “Buy Now!”  
button below to download the  
complete manual.



After you pay.

You can download the most  
perfect and complete manual in  
the world immediately.

Our support email:

[ebooklibonline@outlook.com](mailto:ebooklibonline@outlook.com)