

JOHN DEERE
WORLDWIDE COMMERCIAL & CONSUMER
EQUIPMENT DIVISION

**180cm/223cm Side Discharge and
72 Inch Rear Discharge for 1505
180cm/120cm Rear Discharge for 1515**

OMDMU212202 B0

OPERATOR'S MANUAL



JOHN DEERE

Original Instruction

All information, illustrations and specifications in this manual are based on the latest information at the time of publication. The right is reserved to make changes at any time without notice.

**COPYRIGHT© 2010
Deere & Co.**

**John Deere Worldwide Commercial and
Consumer Equipment Division**

**All rights reserved
Previous Editions
COPYRIGHT©**

**Export Version
Litho in U.S.A.**

INTRODUCTION

Introduction

Using Your Operator's Manual

Read this entire operator's manual, especially the safety information, before operating.

This manual is an important part of your machine. Keep all manuals in a convenient location so they can be accessed easily.

Use the safety and operating information in the attachment operator's manual, along with the machine operator's manual, to operate and service the attachment safely and correctly.

If your attachment manual has a section called Preparing the Machine, it means that you will have to do something to your tractor or vehicle before you can install the attachment. The Assembly and Installation sections of this manual provide information to assemble and install the attachment to your tractor or vehicle. Use the Service section to make any needed adjustments and routine service to your attachment.

If you have any questions or concerns with the assembly, installation, or operation of this attachment, see your local John Deere dealer or call the John Deere Customer Contact Center at 1-800-537-8233 for assistance.

Warranty information on this John Deere attachment can be found in the warranty that came with your John Deere tractor or vehicle.

Machine Use

This machine is designed solely for use in customary lawn mowing operations. Use in any other way is considered as contrary to the intended use.

The manufacturer accepts no liability for damage or injury resulting from this misuse, and these risks must be borne solely by the user. Compliance with and strict adherence to the conditions of operation, service and repair as specified by the manufacturer also constitute essential elements for the intended use.

This machine should be operated, serviced and repaired only by persons familiar with all its particular characteristics and acquainted with the relevant safety rules (accident prevention). The accident prevention regulations, all other generally recognized regulations on safety and occupational medicine and the road traffic regulations must be observed at all times.

Setting fuel delivery beyond published factory specifications or otherwise overpowering will result in loss of warranty protection for this machine.

Any arbitrary modifications carried out on this machine will relieve the manufacturer of all liability for any resulting damage or injury.

Product Identification

Product Compatibility

The 180 cm / 223 Side Discharge and the 72 Inch Rear Discharge Mower Decks are compatible with the 1505.

The 180 cm Rear Discharge and the 120 cm Wing Deck are compatible with the 1515

Record Identification Numbers

Front Mower Decks

180cm Side Discharge Serial No. (DM0648 x 000204 -)

72 Inch Rear Discharge Serial No. (DM7289 x 215099-)

180 cm Rear Discharge Serial No. (DM0649 x 000628 -)

120cm Rear Discharge Serial No. (DM0817 x 000312 -)

223cm Side Discharge Serial No. (DM0762 x 000100 -)

If you need to contact an Authorized Service Center for information on

servicing, always provide the product model and serial number.

You will need to locate the model and serial numbers (A) for the mower deck and record the information in the spaces provided below.

180 cm / 223 cm Deck



DM1143

72 Inch Deck

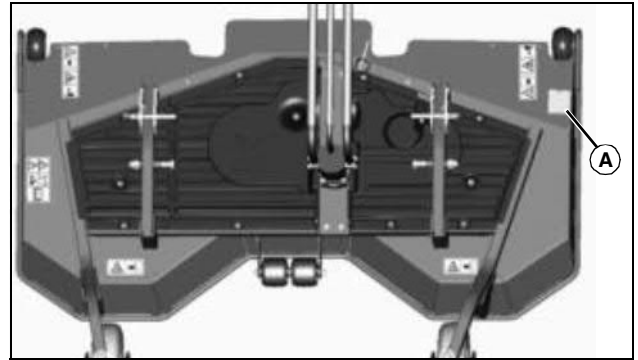

DM2861

120 cm Deck

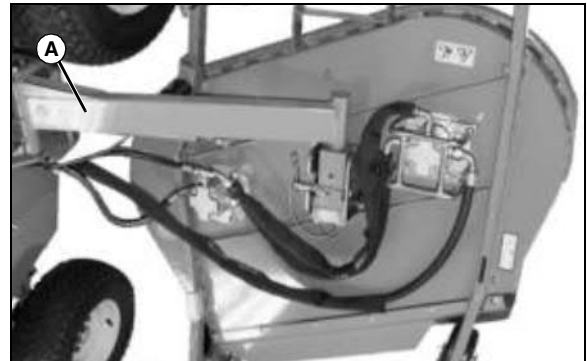

DM1066

DATE OF PURCHASE:

DEALER NAME:

DEALER PHONE:

PRODUCT SERIAL NUMBER (A):

Safety Labels

SAFETY LABELS



Pictorial Safety Signs

At several important places on this machine safety signs are affixed intended to signify potential danger. The hazard is identified by a pictorial in a warning triangle. An adjacent pictorial provides information how to avoid personal injury.

These safety signs, their placement on the machine and a brief explanatory text are shown in this Safety section.

There can be additional safety information contained on parts and components sourced from suppliers that is not reproduced in this operator's manual.

Avoid Injury From Rotating Blades - M118041

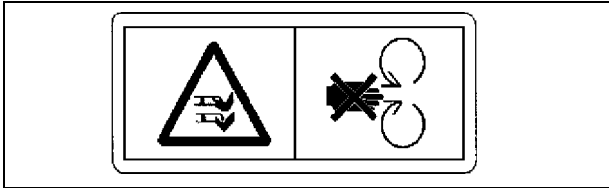

M118041

- Do not put hands or feet under or into mower when engine is running.
- Do not operate mower without discharge chute or entire grass catcher in place.

Avoid Injury From Rotating Blades and Thrown Objects - M118040

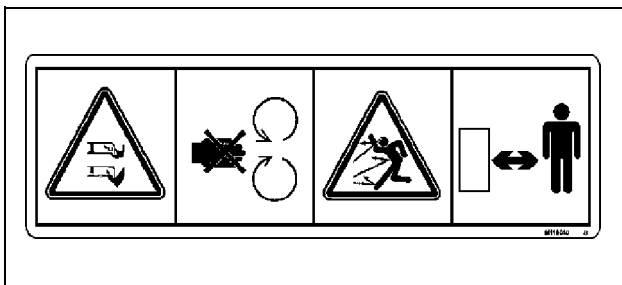

M118040

- Do not put hands or feet under or into mower when engine is running.
- Do not operate mower without discharge chute or entire grass catcher in place.
- Before mowing, clear area of objects that may be thrown by blade.
- Stay clear while engine is running.

Read Operators Manual

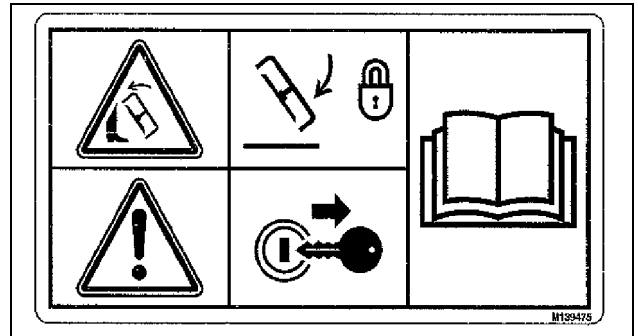

M139475

Avoid Bodily Injury

- Do not operate mower with shields removed.
- Keep hands and feet away from mower deck when engine is running.
- Remove ignition key before leaving mower.
- Blades are sharp: use extreme care if deck is raised.
- Read, understand, and follow all instructions in the operator's manual.
- Keep feet away when lowering the deck to the ground.

Before Servicing

- Lower or secure mower in raised position with service lock.
- Shut off engine and remove ignition key before performing service.

DANGER - STOP - Z59868



Z59868

Do not put hands or feet under or into deck when engine is running.

SAFETY

Keep a Safe Distance

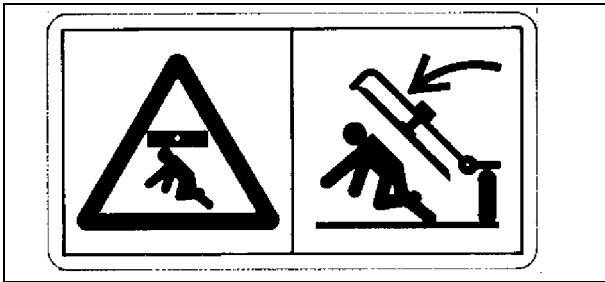

DM1068

Stay clear of raised mower deck.

CE Certification

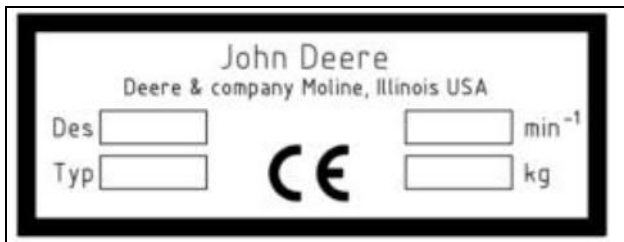

EPC104325A4

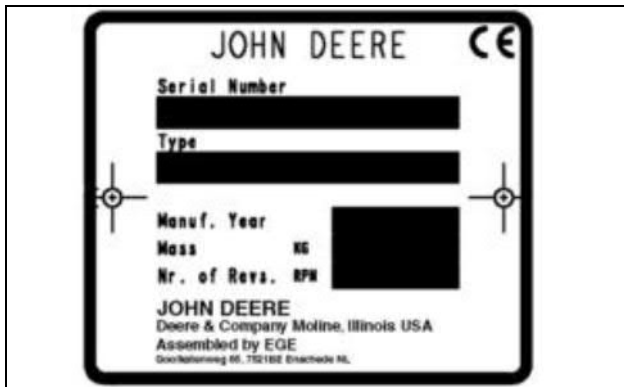

DM2986

This Serial Plate on your mower deck indicates that this model has been certified and is in compliance with applicable European Directives.

Safety

Training

- Read the instructions carefully. Be familiar with the controls and the proper use of the equipment.
- Never allow children or people unfamiliar with these instructions to use the lawnmower. Local regulations can restrict the age of the operator.
- Never mow while people, especially children, or pets are nearby.
- Keep in mind that the operator or user is responsible for accidents or hazards occurring to other people or their property.
- Do not carry passengers.

Preparation

- While mowing, always wear substantial footwear and long trousers. Do

not operate the equipment when barefoot or wearing open sandals.

- Thoroughly inspect the area where the equipment is to be used and remove all objects which can be thrown by the machine.
- Before using, always visually inspect to see that the blades, blade bolts and cutter assembly are not worn or damaged. Replace worn or damaged blades and bolts in sets to preserve balance.
- On multi-bladed machines, take care as rotating one blade can cause other blades to rotate.

Operation

- Do not operate the engine in a confined space where dangerous carbon monoxide fumes can collect.
- Mow only in daylight or in good artificial light.
- Before attempting to start the engine, disengage all blade attachment clutches and shift into neutral.
- Remember there is no such thing as a safe slope. Travel on grass slopes requires particular care. To guard against overturning:
 - never mow across the face of a slope, unless the machine is designed for this purpose.
- Stop the blades from rotating before crossing surfaces other than grass.
- Never direct discharge of material toward bystanders nor allow anyone near the machine while in operation.
- Never operate the machine with defective guards, or without safety protective devices in place.
- Do not change the engine governor settings or overspeed the engine. Operating the engine at excessive speed can increase the hazard of personal injury.
- Before leaving the operator's position:
 - disengage the drive to any attachments and lower them;
 - change into neutral and lock the parking brake;
 - stop the engine and remove the key.
- Disengage drive to attachments, stop the engine, disconnect the spark plug wires and remove the ignition key:
 - before clearing blockages or unclogging chute;
 - before checking, cleaning, or working on the machine;
 - after striking a foreign object. Inspect the machine for damage and make repairs before restarting and operating the equipment;
 - if the machine starts to vibrate abnormally (check immediately).
- Disengage drive to attachments when transporting or not in use.
- Stop the engine and disengage drive to attachment:
 - before refueling;
 - before removing the grass catcher;
 - before making height adjustment unless adjustment can be made from the operator's position.
- Reduce the throttle setting during run-out and, if the engine is provided with a shut-off valve, turn the fuel off at the conclusion of mowing.
- Inspect machine before you operate. Repair or replace damaged, badly worn, or missing parts. Make any necessary adjustments before you operate.
- Do not operate mower without discharge chute or entire grass catcher in place. Never operate with the discharge deflector raised, removed, or altered, unless using a grass catcher.

SAFETY

- Stop machine if anyone enters the area.
- Use only accessories and attachments approved by the manufacturer of the machine. Keep safety labels visible when installing accessories and attachments.
- Never raise mower decks when blades are running.

Maintenance and Storage

- Keep all nuts, bolts and screws tight to be sure the equipment is in safe working condition.
- Never store the equipment with fuel in the tank inside a building where fumes can reach an open flame or spark.
- Allow the engine to cool before storing in any enclosure.
- To reduce the fire hazard, keep the engine, silencer, battery compartment and fuel storage area free of grass, leaves, or excessive grease.
- Check the grass catcher frequently for wear or deterioration.
- Replace worn or damaged parts for safety.
- If the fuel tank has to be drained, this should be done outdoors.
- On multi-bladed machines, take care as rotating one blade can cause other blades to rotate.
- When machine is to be parked, stored or left unattended, lower the cutting means unless a positive mechanical lock is used.
- Use jack stands or lock service latches to support components when required. Securely support any machine elements that must be raised for service work.
- Before servicing machine or attachment, carefully release pressure from any components with stored energy, such as hydraulic components or springs.
- Release hydraulic pressure by lowering attachment or cutting units to the ground or to a mechanical stop and move hydraulic control levers back and forth.
- Disconnect battery or remove spark plug (for gas engines) before making any repairs. Disconnect the negative terminal first and the positive last. Reconnect positive first and negative last.
- Use care when checking blades. Wrap the blades or wear gloves, and use caution when servicing them. Only replace blades. Never straighten or weld them.
- Keep hands, feet, clothing, jewelry and long hair away from moving parts. If possible, do not make adjustments with the engine running.
- Charge batteries in an open well ventilated area, away from spark and flames. Unplug charger before connecting or disconnecting from battery. Wear protective clothing and use insulated tools.

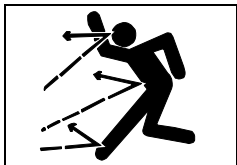

Checking Mowing Area

- Clear mowing area of objects that might be thrown. Keep people and pets out of mowing area.
- Low-hanging branches and similar obstacles can injure the operator or interfere with mowing operation. Before mowing, identify potential obstacles such as low-hanging branches, and trim or remove those obstacles.
- Study mowing area. Set up a safe mowing pattern. Do not mow where traction or stability is doubtful.
- Test drive area with mower lowered but not running. Slow down when you travel over rough ground.

Parking Safely

1. Stop machine on a level surface, not on a slope.
2. Disengage mower blades or any other attachments.
3. Lower attachments to the ground.
4. Lock the park brake.
5. Stop the engine.
6. Remove the key.
7. Wait for engine and all moving parts to stop before you leave the operator's seat.
8. Close fuel shut-off valve, if your machine is equipped.
9. Disconnect the negative battery cable or remove the spark plug wire(s) (for gasoline engines) before servicing the machine.

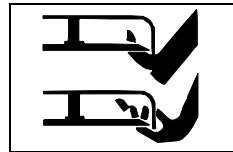

Rotating Blades are Dangerous

HELP PREVENT SERIOUS OR FATAL ACCIDENTS:

- Rotating blades can cut off arms and legs, and throw objects. Failure to observe safety instructions could result in serious injury or death.
- Keep hands, feet and clothing away from mower deck when engine is running.
- Be alert at all times, drive forward and in reverse carefully. People, especially children can move quickly into the mowing area before you know it.
- Before backing up, stop mower blades or attachments and look down and behind the machine carefully, especially for children.
- Do not mow in reverse.
- Shut off blades when you are not mowing.
- Park machine safely before leaving the operator's station for any reason including emptying the grasscatchers or unplugging the chute.
- The mower blades should stop in approximately five seconds when the mower is disengaged. If you believe that your blades may not be stopping in that period of time, take your machine to your authorized dealer where they can safely check and service your machine.

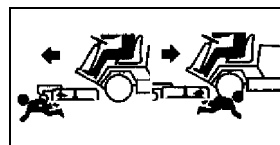

Protect Children

- Death or serious injury can occur when young children associate having fun with a lawn mowing machine simply because someone has given them a ride on a machine.
- Children are attracted to lawn mowing machines and mowing activities. They don't understand the dangers of rotating blades or the fact that the operator is unaware of their presence.
- Children who have been given rides in the past may suddenly appear in the mowing area for another ride and be run over or backed over by the machine.
- Tragic accidents with children can occur if the operator is not alert to the presence of children, especially when a child approaches a machine from behind. Before and while backing up, stop mower blades and look down and behind the machine carefully, especially for children.
- Never carry children on a machine or attachment, even with the blades off. Do not tow children in a cart or trailer. They can fall off and be seriously injured or interfere with safe machine operation.

Buy Now



Our support email:

ebooklibonline@outlook.com