

JOHN DEERE
WORLDWIDE COMMERCIAL & CONSUMER
EQUIPMENT DIVISION

Material Collection Utility Cart
MC519

OMM154820 D0

OPERATOR'S MANUAL



JOHN DEERE

Original Instruction

All information, illustrations and specifications in this manual are based on the latest information at the time of publication. The right is reserved to make changes at any time without notice.

COPYRIGHT© 2010
Deere & Co.

John Deere Worldwide Commercial and Consumer Equipment Division

All rights reserved
Previous Editions
COPYRIGHT© 2005

North American Version
Litho in U.S.A.

SAFETY

Table of Contents

Safety	1
Introduction.....	2
Product Identification.....	2
Preparing Vehicle	2
Assembly.....	3
Installing	9
Removing and Storing.....	10
Operating	12
Service	15
Service Intervals.....	15
Troubleshooting	15
Specifications	16
Getting Quality Service	16

Safety

Read Safety in Machine Operator's Manual

Read the general safety operating precautions in your machine operator's manual for additional safety information.

Operating Safely

- Read, understand and follow all instructions in this attachment manual, the machine operator's manual and safety signs on equipment before starting.
- This attachment is intended for use in lawn care and home applications. Do not tow behind a vehicle on a highway or in any high speed application. Do not tow at speeds higher than maximum recommended towing speed.
- Towing speed should always be slow enough to maintain control. Travel slowly over rough ground.
- Do not operate material collection system unless entire grass catcher is fastened in place with enclosure securely attached to cart.
- Do not let anyone ride on the mower or material collection system. Riders are subject to injury such as being struck by foreign objects or being thrown off. Riders may obstruct the operator's view and cause a collision.
- Check machine brake action before you operate. Adjust or service brakes as necessary.
- Keep all parts in good condition and properly installed. Fix damage immediately. Replace worn or broken parts. Replace all worn or damaged safety and instruction decals.
- Do not modify machine or safety devices. Unauthorized modifications to the machine or attachment may impair its function and safety.
- Reduce loaded cart weight on slippery surfaces.
- Traction decreases when moving in reverse.
- Tractor and operator must exceed weight of loaded cart.

Before backing up machine:

- Stop machine.
- Look behind hopper for children.
- Keep bystanders away when unloading material collection system.

Enclosure Maintenance:

- Enclosure is subject to wear and deterioration.
- Check enclosure frequently; replace when necessary.
- Use John Deere enclosure or equivalent to comply with safety specifications.
- Do not leave clippings in cart overnight.

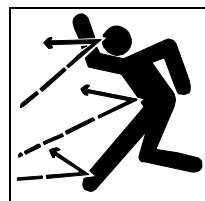

Avoid Injury From Thrown Objects

- When operating the vehicle with the MCS attachment installed make sure all chutes and hoses are securely in place. Keep hopper closed or MCS in operating position.
- Stop the engine and wait for all moving parts to stop before removing or lifting any attachment components.
- Avoid injury from impeller blades and thrown objects. Remove attachment when operating vehicle in side discharge mode. Make sure deflector shield is in place on mower deck if attachment is removed.

INTRODUCTION

Towing Loads Safely

- Stopping distance increases with speed and weight of towed load. Travel slowly and allow extra time and distance to stop.
- Total towed weight must not exceed limits specified in towing vehicle operator's manual.
- Excessive towed load can cause loss of traction and loss of control on slopes. Reduce towed weight when operating on slopes.
- Never allow children or others in or on towed equipment.
- Use only approved hitches. Tow only with a machine that has a hitch designed for towing. Do not attach towed equipment except at the approved hitch point.
- Follow the manufacturer's recommendations for weight limits for towed equipment and towing on slopes. Use counterweights or wheel weights as described in the machine operator's manual.
- Do not turn sharply. Use additional caution when turning or operating under adverse surface conditions. Use care when reversing.
- Do not shift to neutral and coast downhill.

Avoid Injury From Drawbar

Before you disconnect an attachment from machine hitch plate:

- Unload attachment.
- Stop attachment on level ground.
- Stop machine engine.
- Lock machine park brake.
- Block attachment wheels.
- Make sure hands, feet or other body parts are not under drawbar.

Introduction

Using Your Operator's Manual

Read this entire operator's manual, especially the safety information, before operating.

This manual is an important part of your machine. Keep all manuals in a convenient location so they can be accessed easily.

Use the safety and operating information in the attachment operator's manual, along with the machine operator's manual, to operate and service the attachment safely and correctly.

If your attachment manual has a section called Preparing the Machine, it means that you will have to do something to your tractor or vehicle before you can install the attachment. The Assembly and Installation sections of this manual provide information to assemble and install the attachment to your tractor or vehicle. Use the Service section to make any needed adjustments and routine service to your attachment.

If you have any questions or concerns with the assembly, installation, or operation of this attachment, see your local John Deere dealer or call the John Deere Customer Contact Center at 1-800-537-8233 for assistance. Warranty information on this John Deere attachment can be found in the warranty that came with your John Deere tractor or vehicle.

Product Identification

Product Compatibility

This material collection utility cart is compatible with the X324, X340, X360, X500, X520, X534, and X540 tractors.

Record Purchase Information

Material Collection Utility Cart

MC519

Record your purchase information in the spaces provided below.

DATE OF PURCHASE:

DEALER NAME:

DEALER PHONE:

Preparing Vehicle

Installing MC519 Cart Hardware

1. Move tractor and cart to level ground.
2. Stop engine.
3. Lock park brake.
4. Remove rear suitcase weights, if tractor is so equipped. These weights are not compatible with cart. Rear wheel weights are used if ballast is required.

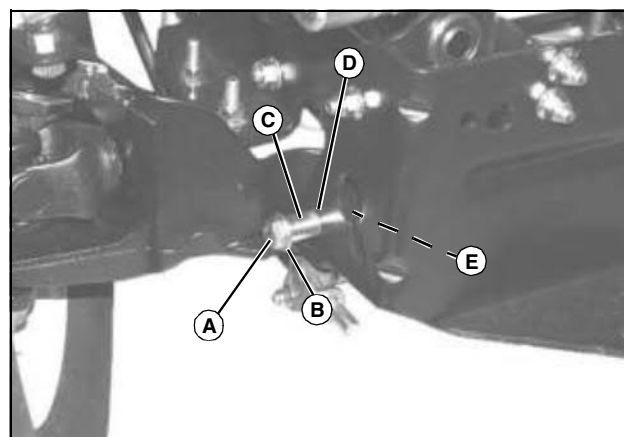

MX36373

5. Insert 1/2 x 2 in. hex head bolts (A), washer (B), and spacer (C) through lower holes (D) on both sides of tractor rear frame.
6. From the inside of frame, install 1/2 in. lockwashers and 1/2 in. nuts (E). Tighten hardware securely.

Material Collection Cart Adjustments

NOTE: Making sure cart box is level with ground will:

- Make dumping of load easier.
- Distribute load more evenly.
- Make cart more level with ground.

ASSEMBLY

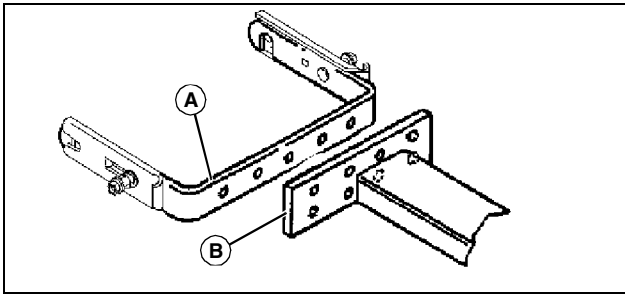

M72474

The vertical adjustment is a 2-position adjustment. This adjustment is made on the drawbar hitch plate (B) and quik-tatch bracket (A).

The side-to-side adjustment is a 3-position adjustment. This adjustment is made on the quik-tatch bracket (A) and drawbar hitch plate (B).

Side-To-Side and Vertical Adjustments:

1. Remove bolts, lockwashers, and nuts.

IMPORTANT: Avoid damage! Chute must not contact any part of the tractor as a result of adjustment.

2. Position cart drawbar hitch plate as close as possible to center of tractor. Make sure to allow clearance for the power-flow discharge to cart chute with the tractor's fender deck and right tire.

3. Move quik-tatch bracket:

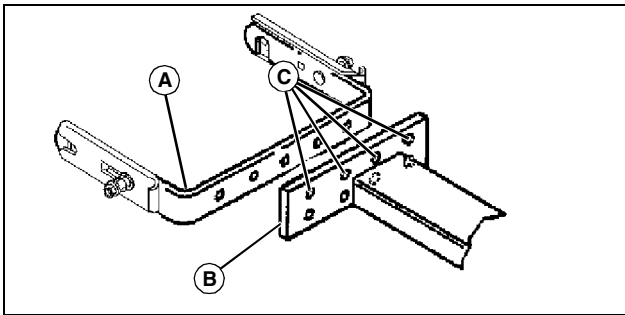

M72474

4. Move quik-tatch bracket (A) to appropriate hole (C) on drawbar hitch plate (B).

5. Install bolts, lockwashers, and nuts removed previously. (Nuts go to the inside of bracket.)

6. Tighten nuts.

Assembly

Identify Parts

Parts in Large Box:

- Cover
- Tailgate
- POWERFLOW Chute
- Cart Box
- Wheel Assembly
- Quik-Tatch Bracket
- Side Plate (2)

- Lift Handle Bracket Assembly
- Side Support, Cover (2)
- Support Rod, Cover (2)
- Gas Cylinder, Preloaded

Parts in Small Box:

- Cable and Chain Assembly
- Bail Assembly
- Cover Latch Lever Assembly
- Gas Cylinder Bracket
- Three Parts Bags

First Parts Bag (Slide Plate and Hardware)

Qty.	Description	Size
2	Slide Plate	
2	Carriage Bolt	5/16 x 1-1/2 in.
4	Washer	
2	Spring	
2	Nut	5/16 in.

Second Parts Bag (Locking Latch and Hardware)

Qty.	Description	Size
1	Plate, Locking Latch	
1	Bolt, Hex Head	5/16 x 3/4 in.
1	Locknut	5/16 in.
1	Cap, Black Vinyl	
4	Carriage Bolt	1/4 x 1-1/2 in.
4	Locknut	1/4 in.
3	Locking Ring	
1	S-Hook	
1	Chain Bracket, Chain-Type (Not used in this application)	
1	Chain Bracket, Flat	
1	Chain Link	

Third Parts Bag (Cargo Box Latches and Hardware)

Qty.	Description	Size
1	Transport Latch	
2	Latch, Tailgate	
2	Pin, Tailgate	
2	Lockwasher	5/16 in.
2	Nut	5/16 in.

ASSEMBLY

Qty.	Description	Size
4	Bolt, Hex Head	5/16 x 3/4 in.
4	Locknut	5/16 in.
2	Bolt, Hex Head	3/8 x 4-1/2 in.
2	Locknut	3/8 in.
4	Screw, Round Head	1/4 x 1/2 in.
4	Lockwasher	1/4 in.
4	Nut	1/4 in.
3	Bolt, Hex Head	1/2 x 1-1/4 in.
2	Bolt, Hex Head	1/2 x 2 in.
5	Lockwasher	1/2 in.
2	Spacer	
2	Washer, Flat	1/2 in.
5	Nut	1/2 in.

Install Lift Handle Bracket

NOTE: Tip cart box on end for ease of installation.

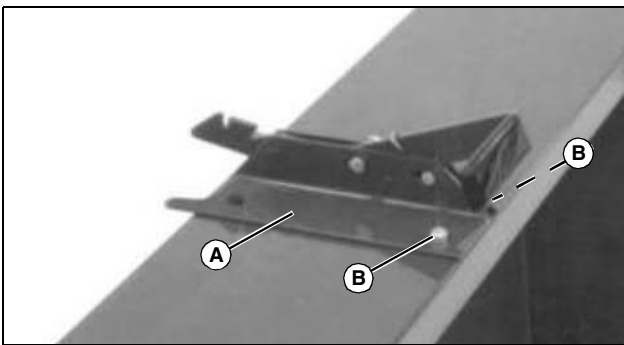

1. Place lift handle bracket (A) on MC519 cart box and fasten top part of bracket with two 5/16 x 3/4 in. hex head bolts (B), and locknuts, with locknuts to the inside of cart box. Do not tighten nuts at this time.

Install Drawbar Assembly

NOTE: Tip cart box flat for ease of installation

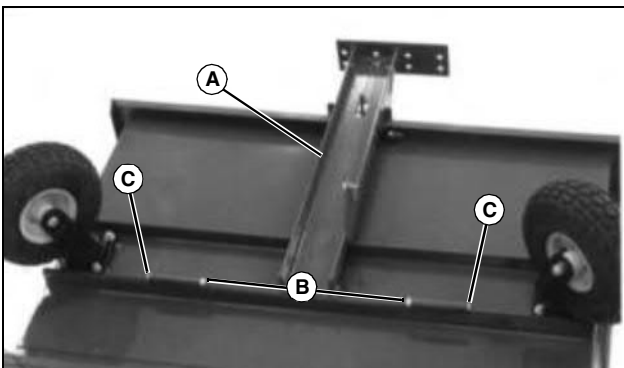

1. Attach drawbar assembly (A) to MC519 cart with two 3/8 x 4-1/2 in. hex

head bolts (B) (one on each side) and locknuts (C).

NOTE: Do not overtighten nuts. Drawbar must pivot freely.

2. Tighten nuts for drawbar only.

Install Gas Cylinder Bracket

NOTE: Tip cart box on end for ease of installation.

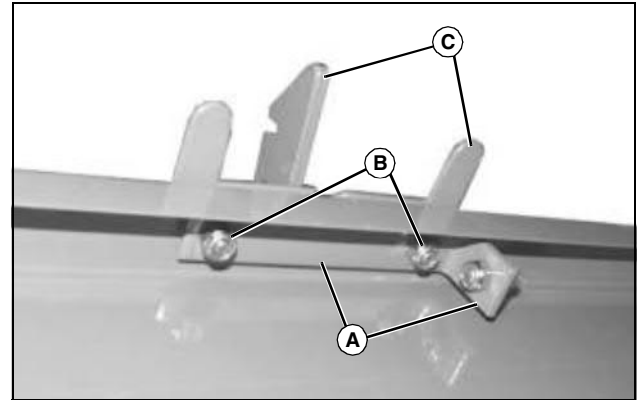

MX36375

1. Install gas cylinder bracket (A) on cart, and fasten with two 5/16 x 3/4 in. hex head bolts and locknuts (B).

NOTE: Bolts go through lift handle bracket (C) first and then gas cylinder bracket (A).

2. Do not tighten nuts at this time.

Install Latch On Drawbar

NOTE: Spread latch slightly for ease of installation.

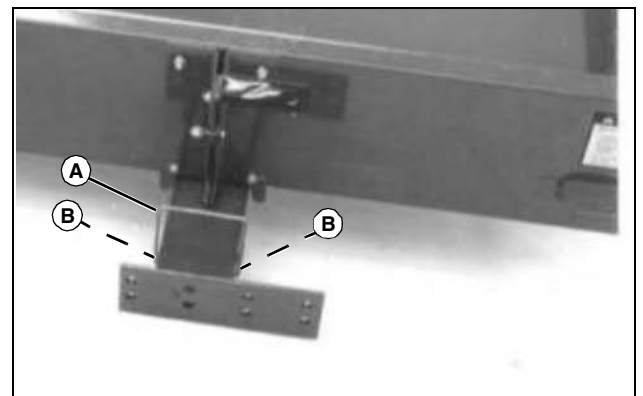

M63429

1. Install latch (A) in holes (B) on drawbar.

NOTE: If dump cart latch does not lock in place when you push down on the cart box, adjust dump cart latch.

2. Push latch to the rear and hook on slot in lift handle.
3. Align lift bracket with drawbar, and tighten all four nuts to secure lift bracket and cylinder bracket.

Thank you so much for reading.
Please click the “Buy Now!”
button below to download the
complete manual.



After you pay.

You can download the most
perfect and complete manual in
the world immediately.

Our support email:

ebooklibonline@outlook.com