

>ST756011 - 11AC VALVE COVER

KEY	PART NO.	PART NAME	QTY	REMARKS	
1	RE552476	HEAT SHIELD	1		
2	RE542918	VALVE	1		
3	19M7774	SCREW	4	M6 X 12	
4	19M7867	SCREW	8	M8 X 25	
5	R522412	O-RING	1		
6	DZ10571	HOSE	1	SUB FOR R536108	
7	DZ101765	VALVE COVER	1	SUB FOR R535805	
8	R550077	DEFLECTOR	1		
9	R535808	GASKET	1		

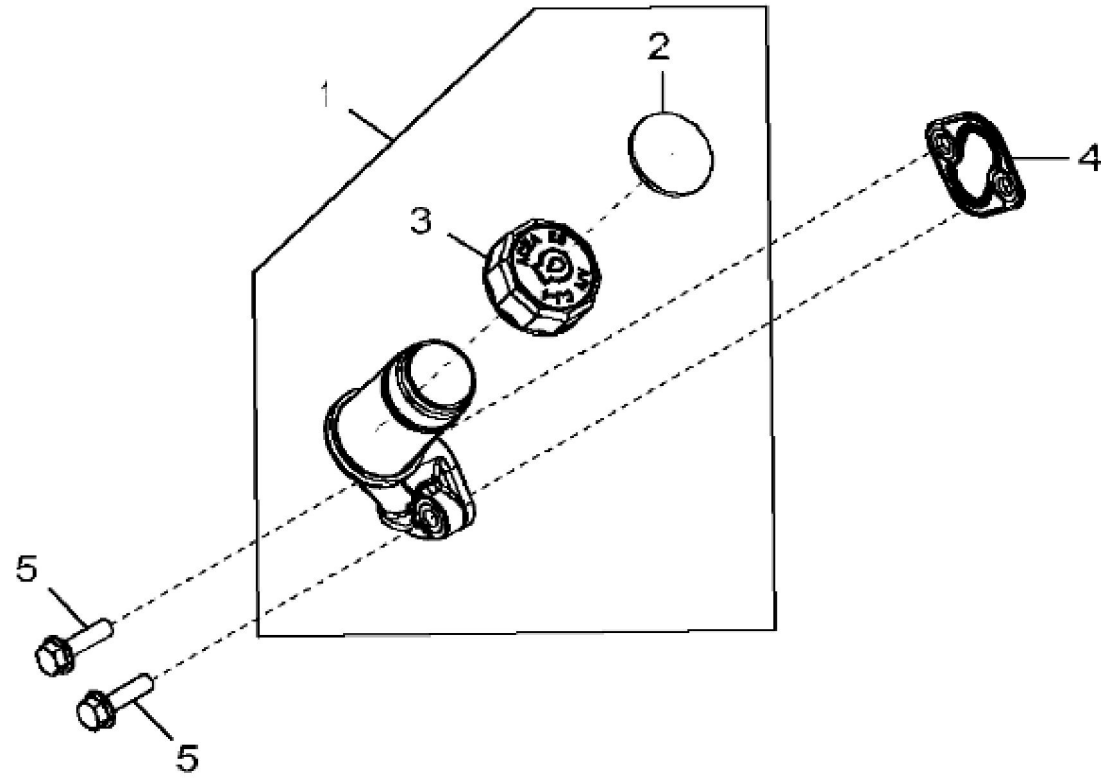

1275_ETN123662_PCD

John Deere > Turf And Utility > TRACTOR > 5075E - TRACTOR > 5075E Tractor (Final Tier 4)(9X3 TSS Transmission and 12X12 PR Transmission)(North America Edition) > 20 ENGINE 3029HPY61-RE571749 > ST798357 - 1275 OIL FILLER COVER

KEY	PART NO.	PART NAME	QTY	REMARKS	
1	DZ10104	FILLER NECK	1		
2	T20328	GASKET	1		
3	R541048	FILLER CAP	1		
4	DZ10105	GASKET	1		
5	19M7868	SCREW	2	M8 X 30	

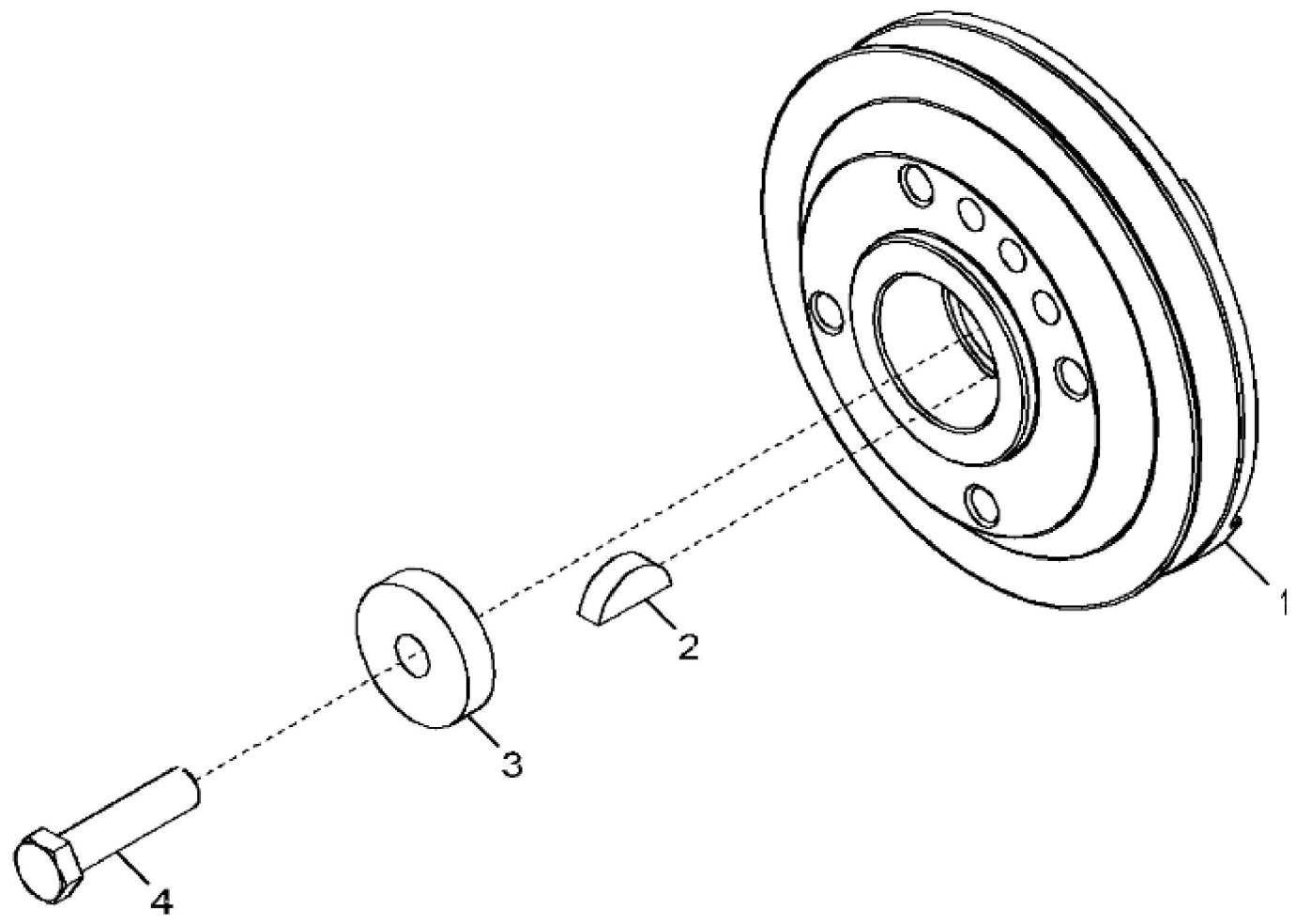

1350_RE551648_PCD

John Deere > Turf And Utility >TRACTOR >5075E - TRACTOR >5075E Tractor (Final Tier 4)(9X3 TSS Transmission and 12X12 PR Transmission)(North America Edition) >20 ENGINE 3029HPY61-RE571749
>ST756041 - 1350 CRANKSHAFT PULLEY

KEY	PART NO.	PART NAME	QTY	REMARKS	
1	R538838	PULLEY	1	MARKED R539503	
2	26H27	SHAFT KEY	1	5/16" X 1-1/8"	
3	R109086	SPACER	1	SUB FOR CD16045	
4	R537016	CAP SCREW	1		

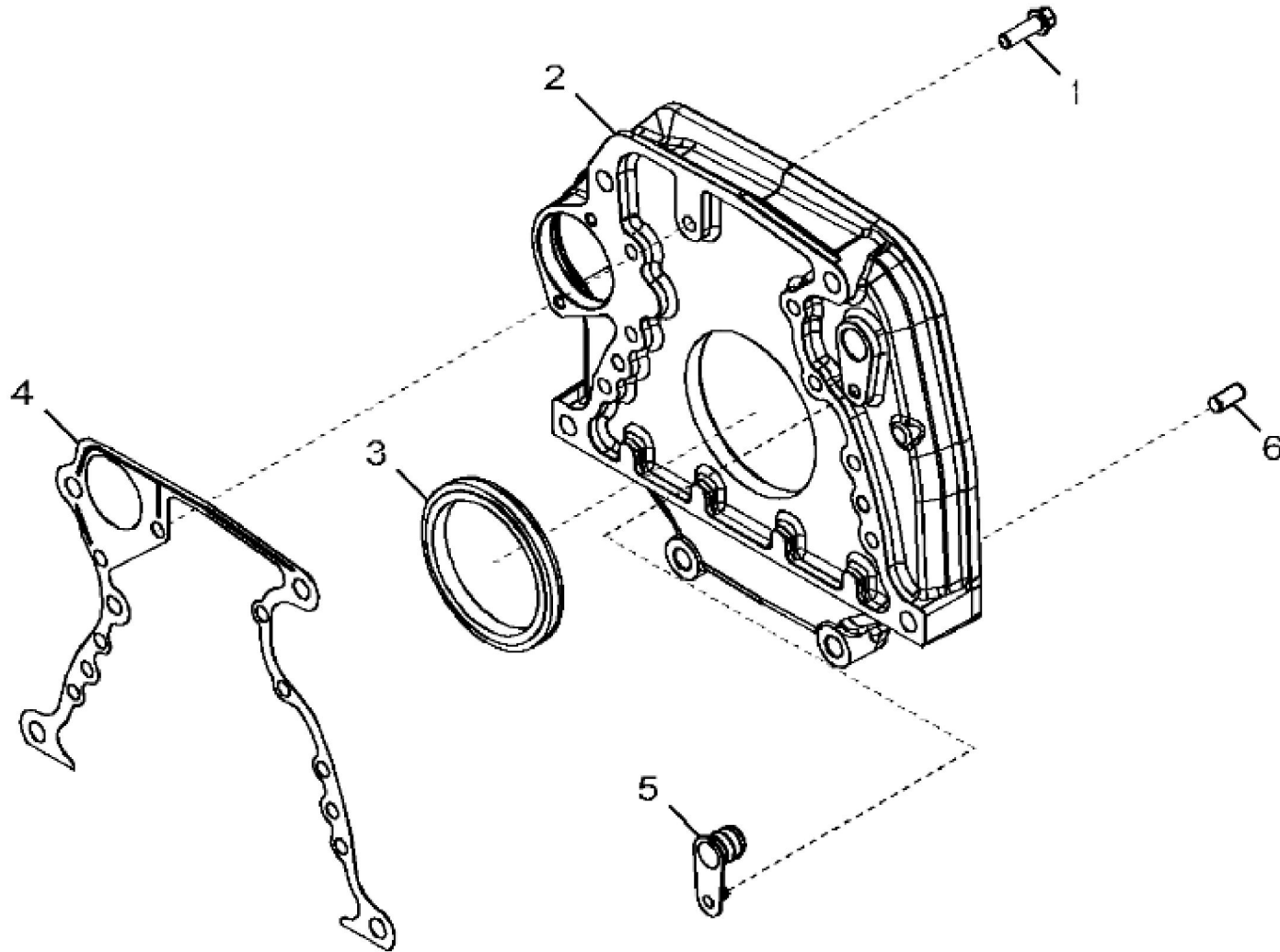

1489_RE549363_PCD

Thank you so much for reading.
Please click the “Buy Now!”
button below to download the
complete manual.



After you pay.

You can download the most
perfect and complete manual in
the world immediately.

Our support email:

ebooklibonline@outlook.com