

John Deere > Turf And Utility >TRACTOR >5115M - TRACTOR >5115M Tractor (Engine 4045HLV72)(North American Edition)(FT4) >20 ENGINE 4045HLV72-RE565006 >ST400926 - 1183 ROCKER ARM COVER

KEY	PART NO.	PART NAME	QTY	REMARKS
1	R524499	GASKET	1	
2	19M7775	SCREW	2	M6 X 16
3	R515555	DEFLECTOR	1	
4	R543296	HOSE	1	
5	TY22462	CLAMP	1	
6	RE561710	VALVE COVER	1	MARKED R540192
7	RE542918	VALVE	1	USE WITH RE561710
8	R123575	O-RING	5	
9	R521390	SCREW	5	
10	H23125	PLUG	5	
11	R529614	VALVE COVER	1	ORDER RE561710
12	R532038	VALVE	1	ORDER RE542918; USE WITH R529614

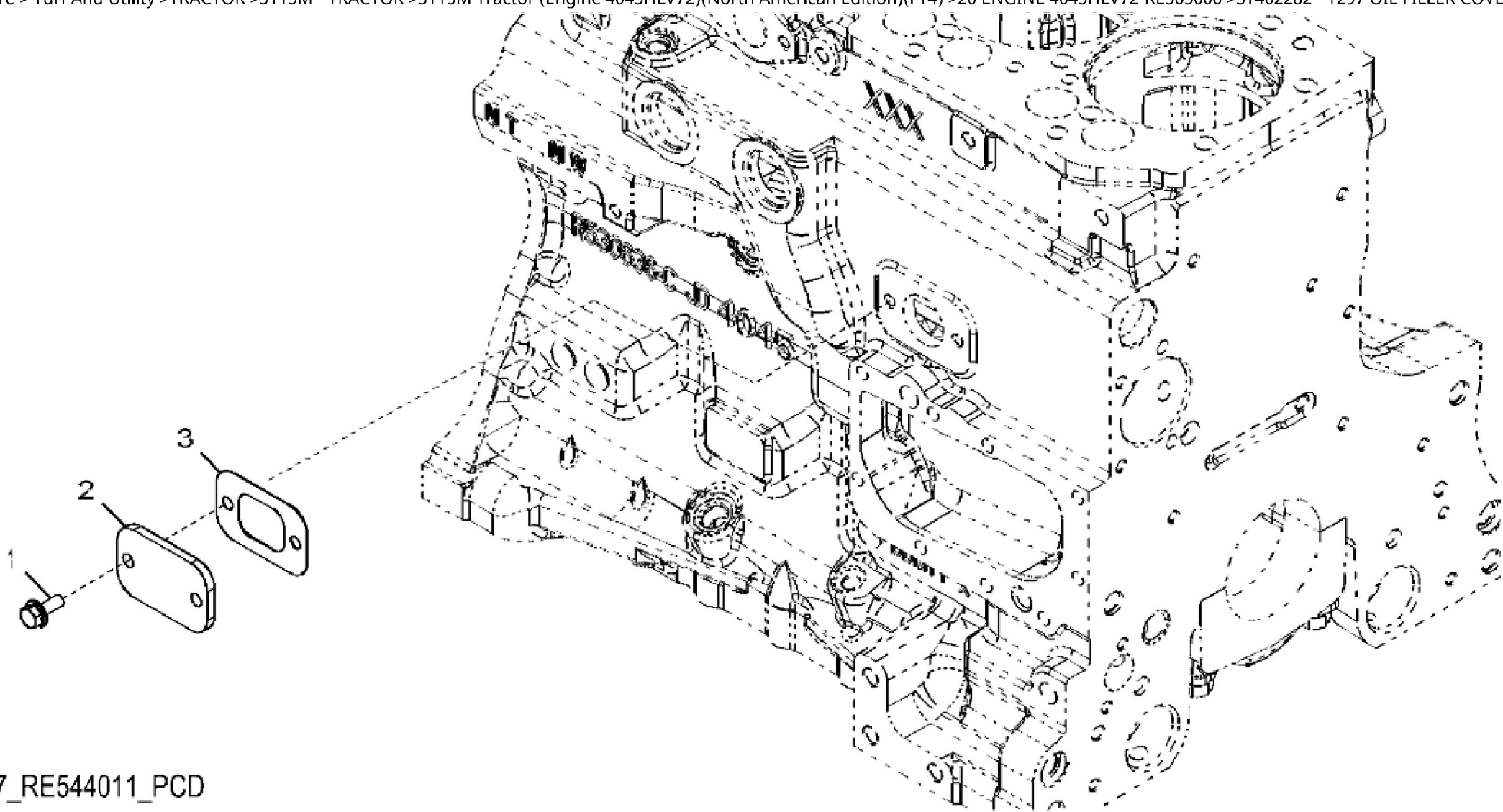

1297\_RE544011\_PCD

KEY	PART NO.	PART NAME	QTY	REMARKS	
1	RE67238	SCREW	2	(Threads With Pre-Applied Sealant)	
2	R116296	COVER	1		
3	R136495	GASKET	1		

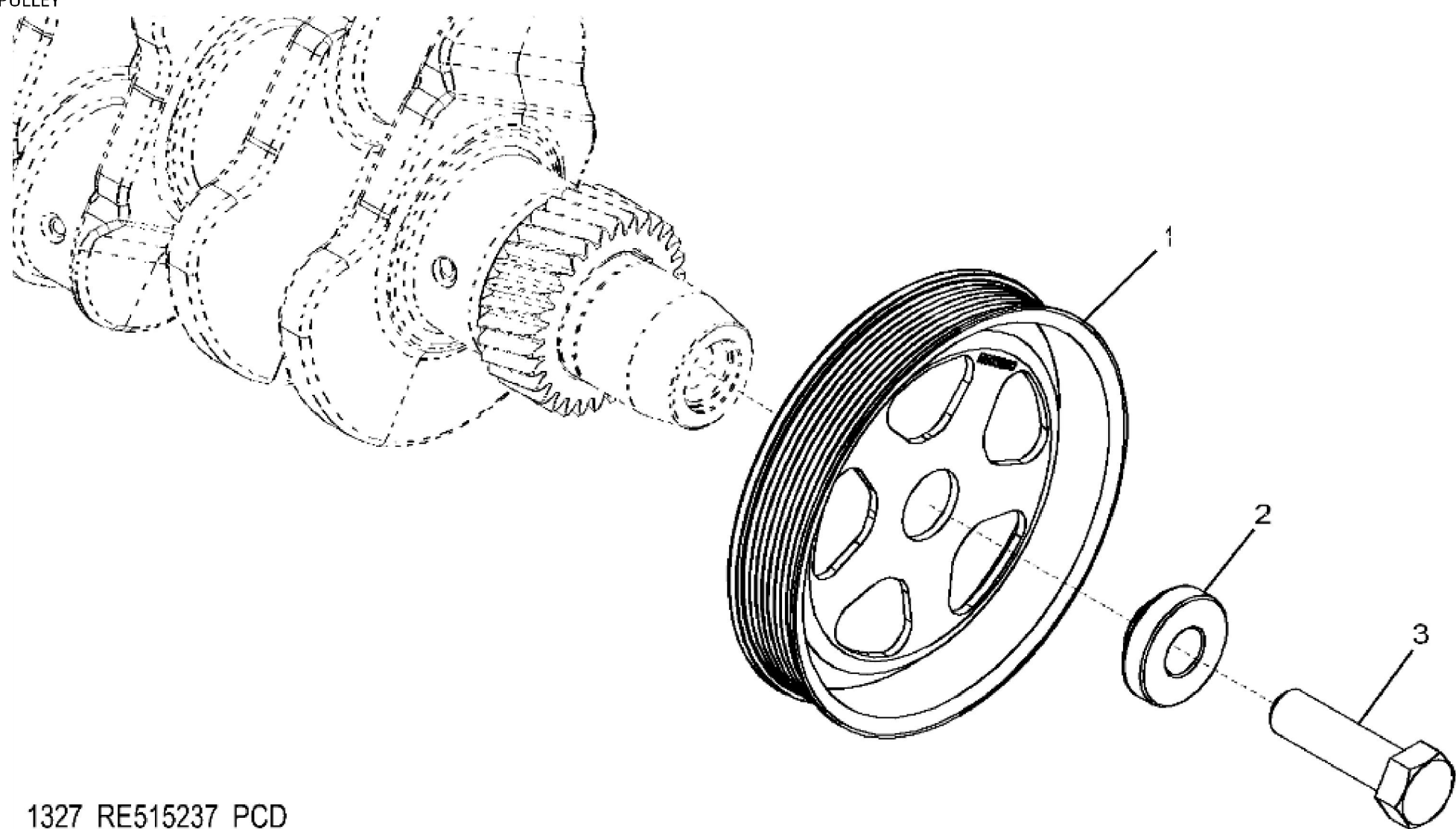

1327\_RE515237\_PCD

John Deere > Turf And Utility > TRACTOR > 5115M - TRACTOR > 5115M Tractor (Engine 4045HLV72)(North American Edition)(FT4) > 20 ENGINE 4045HLV72-RE565006 > ST308624 - 1327 CRANKSHAFT PULLEY

KEY	PART NO.	PART NAME	QTY	REMARKS	
1	R503880	PULLEY	1	OD = 188 mm	
2	R515040	BUSHING	1	OD = 50 mm	
3	R516648	CAP SCREW	1	M20 X 70	

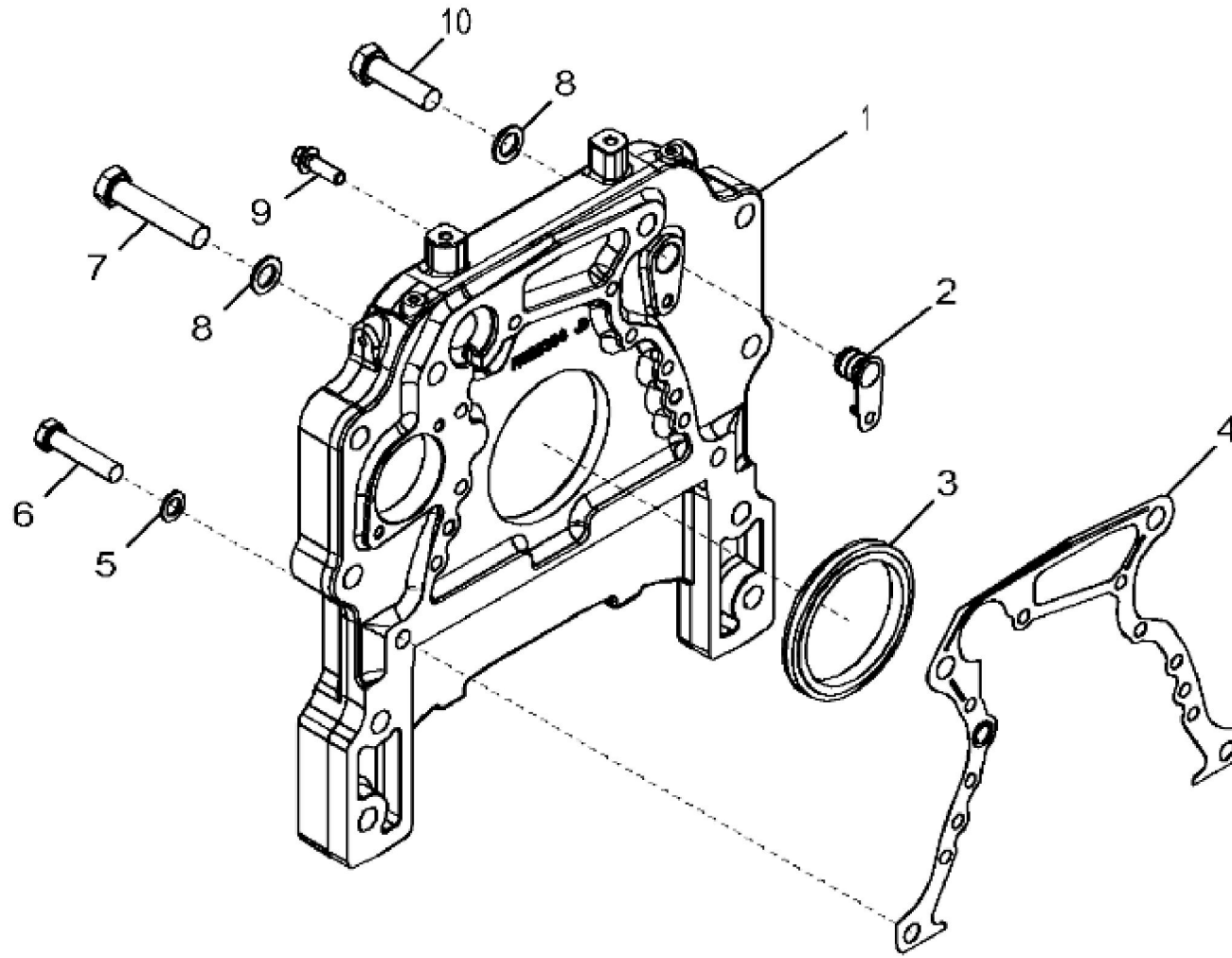

1469\_RE529547\_PCD

Thank you so much for reading.  
Please click the “Buy Now!”  
button below to download the  
complete manual.



After you pay.

You can download the most  
perfect and complete manual in  
the world immediately.

Our support email:

[ebooklibonline@outlook.com](mailto:ebooklibonline@outlook.com)