

ARM COVER

KEY	PART NO.	PART NAME	QTY	REMARKS	
1	R524499	GASKET	1		
2	19M7775	SCREW	2	M6 X 16	
3	R515555	DEFLECTOR	1		
4	R543296	HOSE	1		
5	TY22462	CLAMP	1		
6	RE561710	VALVE COVER	1	MARKED R540192	
7	RE542918	VALVE	1	USE WITH RE561710	
8	R123575	O-RING	5		
9	R521390	SCREW	5		
10	H23125	PLUG	5		
11	R529614	VALVE COVER	1	ORDER RE561710	
12	R532038	VALVE	1	ORDER RE542918; USE WITH R529614	

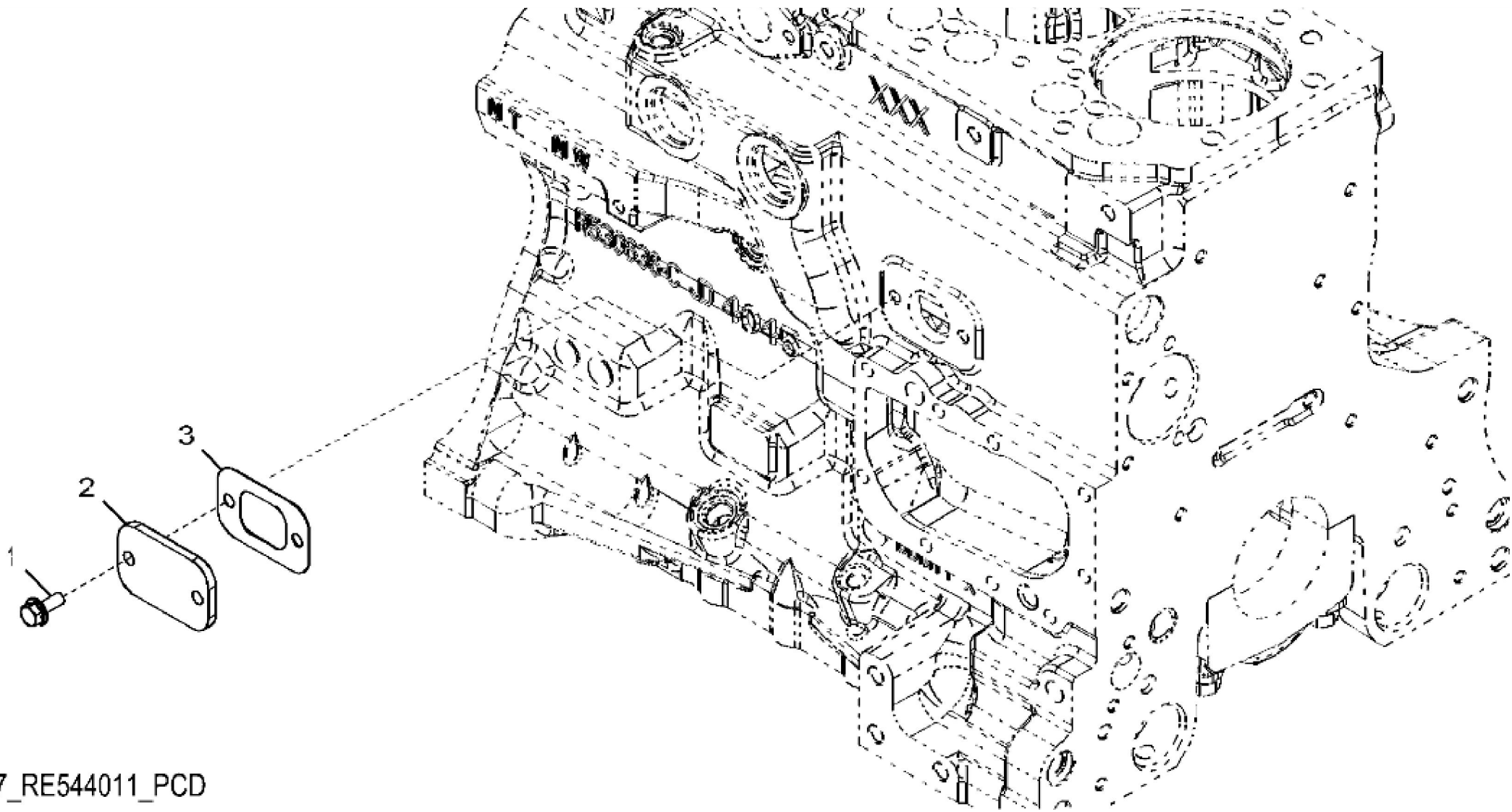

John Deere > Turf And Utility > TRACTOR > 5100E - TRACTOR > 5100E Tractor (Engine: 4045HLV71, Final Tier 4)(North American Edition) > 20 ENGINE 4045HLV71-RE566358 > ST402282 - 1297 OIL FILLER COVER

KEY	PART NO.	PART NAME	QTY	REMARKS	
1	RE67238	SCREW	2	(Threads With Pre-Applied Sealant)	
2	R116296	COVER	1		
3	R136495	GASKET	1		

CRANKSHAFT PULLEY

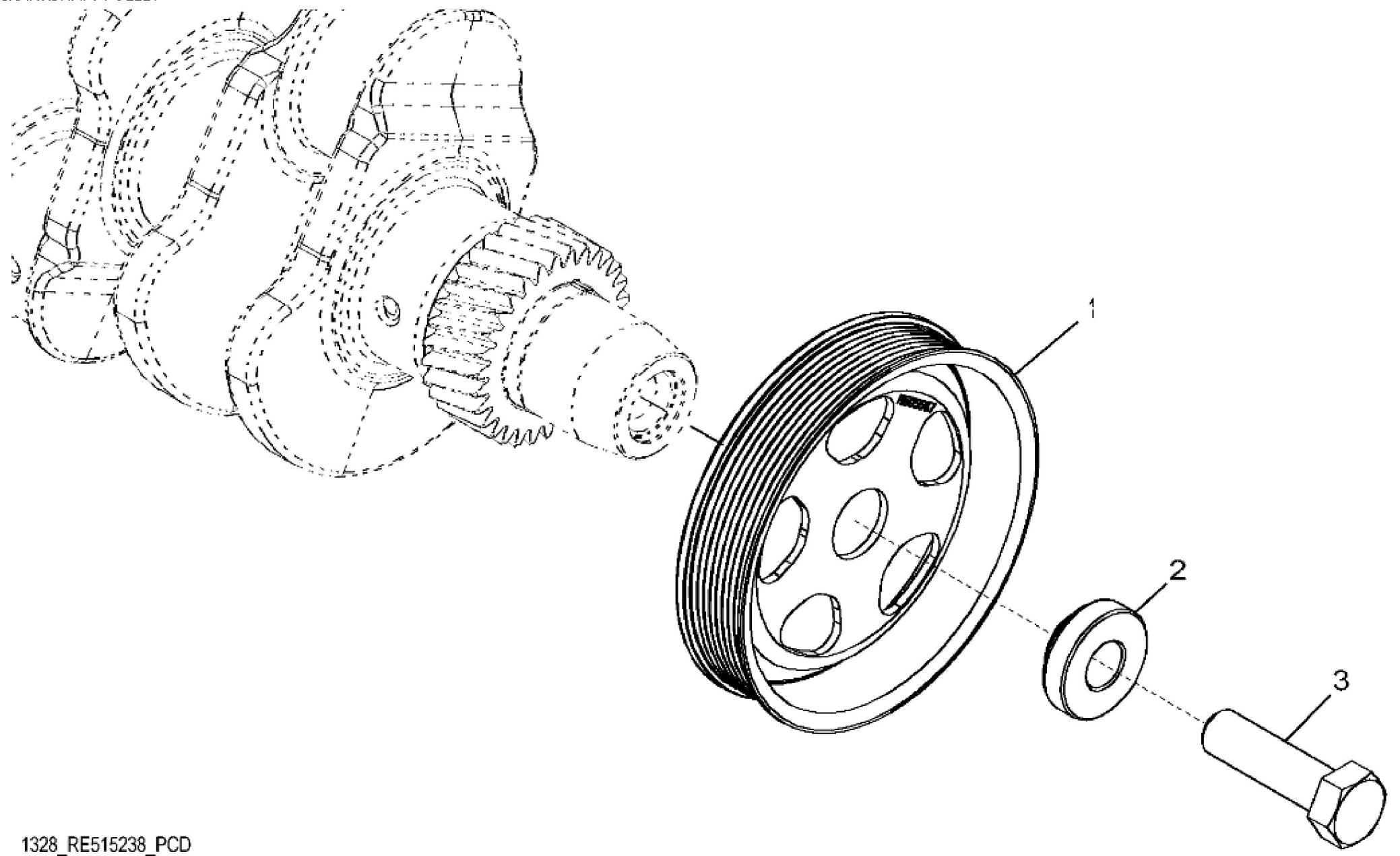

CRANKSHAFT PULLEY

KEY	PART NO.	PART NAME	QTY	REMARKS	
1	R505567	PULLEY	1	OD = 173 mm	
2	R515040	BUSHING	1	OD = 50 mm	
3	R516648	CAP SCREW	1	(One Time Usage) M20 X 70	

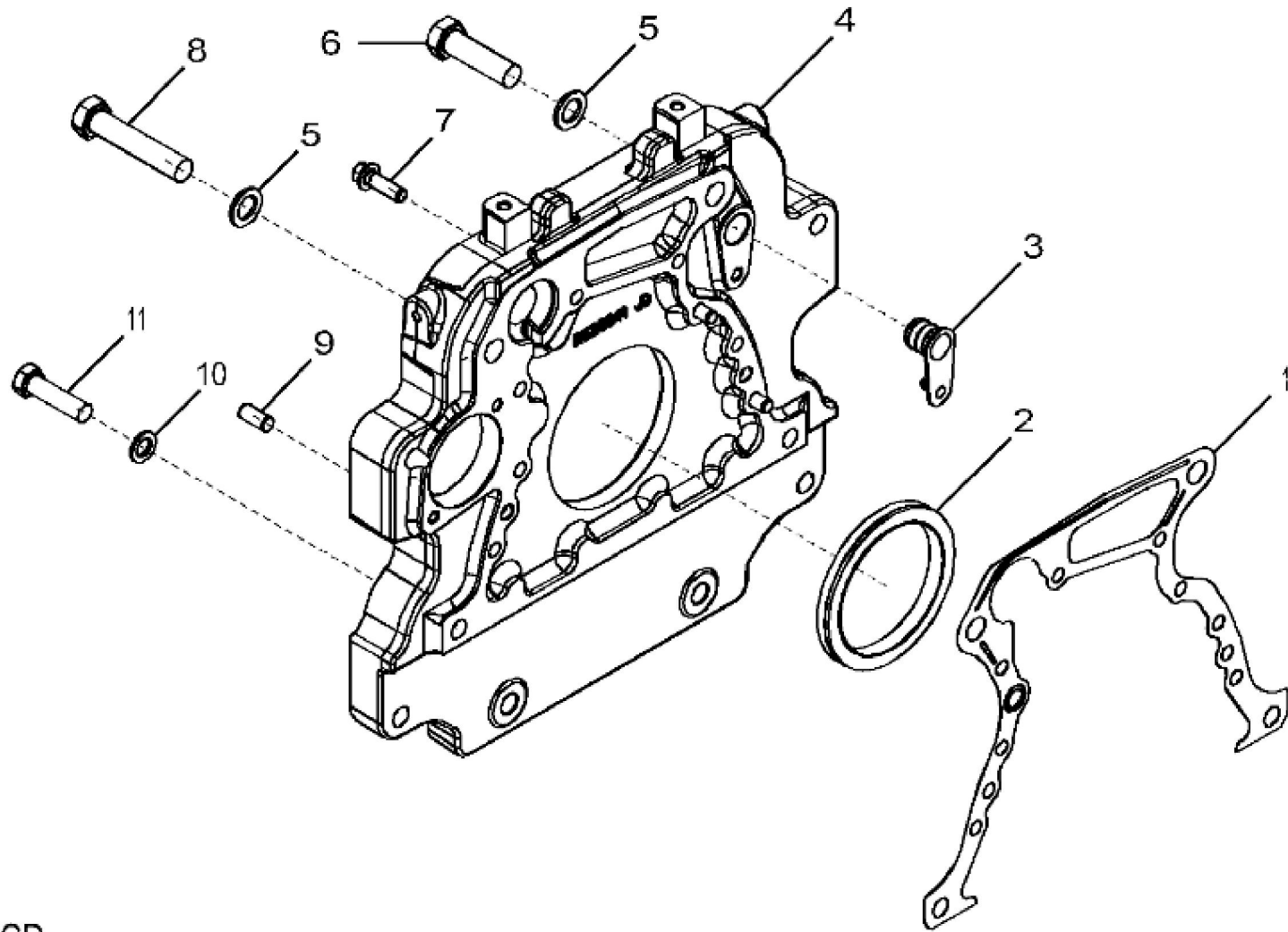

1483_RE541962_PCD

Thank you so much for reading.
Please click the “Buy Now!”
button below to download the
complete manual.



After you pay.

You can download the most
perfect and complete manual in
the world immediately.

Our support email:

ebooklibonline@outlook.com