

RE52486 | PCDB03

John Deere > Turf And Utility >TRACTOR >5090RN - TRACTOR >5090R, 5090RN Tractors (Europe Edition, Engine SN: CD4045LXXXXXX) >24 ENGINE 4045HL284-DD21703 >ST402412 - 1134 VALVE COVER (- 079666)

KEY	PART NO.	PART NAME	QTY	REMARKS	
1	19M7774	SCREW	1	M6 X 12	
2	RE527858	SCREW	2	(Threads With Pre-Applied Sealant)	
3	R522409	HEAT SHIELD	1	ORDER RE539532	
4	H23125	PLUG	4		
5	R123574	NUT	4		
6	R123575	O-RING	4		
7	R520896	VALVE COVER	1		
8	RE528742	DEFLECTOR	1		
9	19M7862	SCREW	1	M6 X 20	
10	R524468	GASKET	1		
11	R521401	MEDALLION	1		

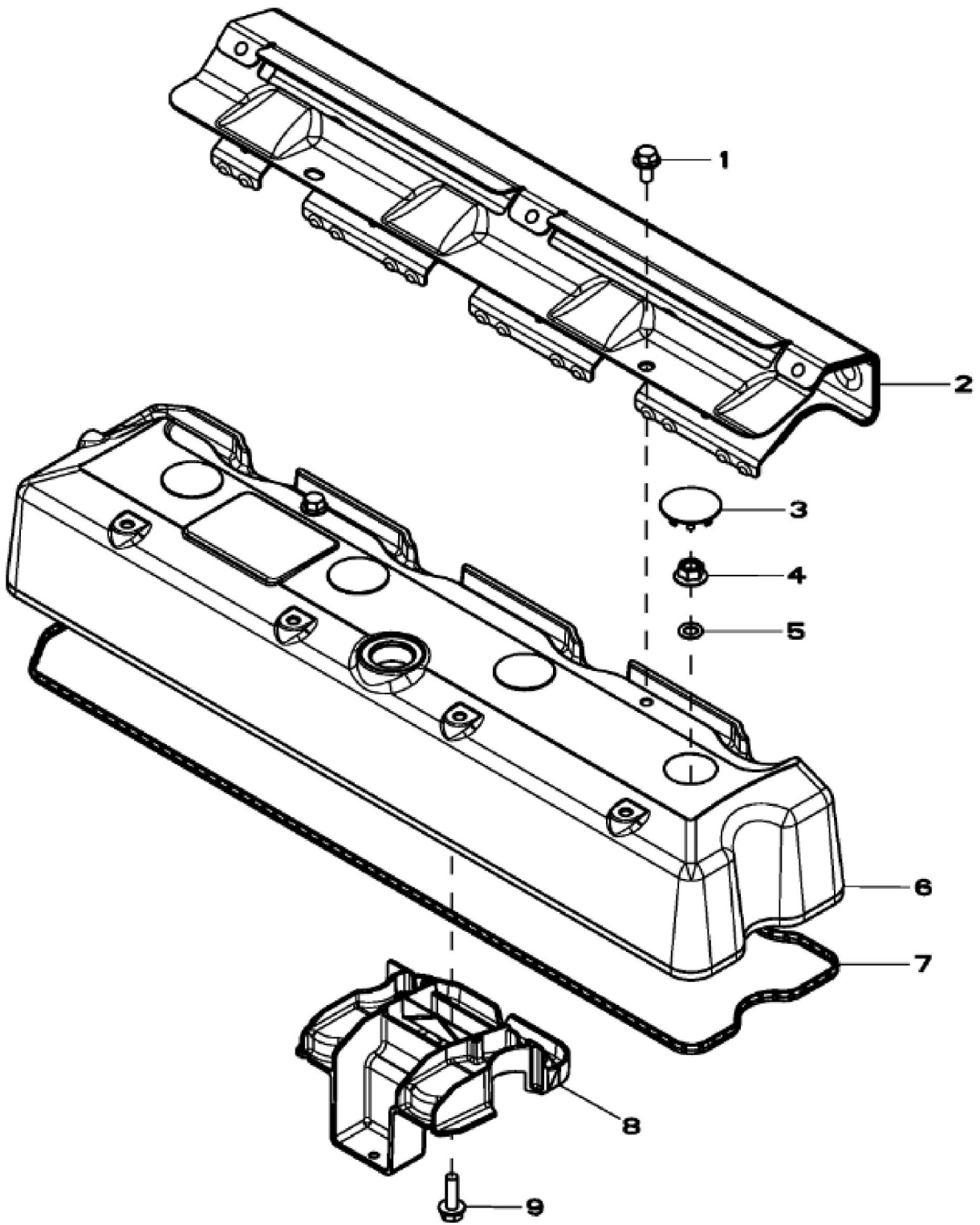

RE539531PCDA01

John Deere > Turf And Utility >TRACTOR >5090RN - TRACTOR >5090R, 5090RN Tractors (Europe Edition, Engine SN: CD4045LXXXXXX) >24 ENGINE 4045HL284-DD21703 >ST402417 - 1173 VALVE COVER (079667 -)

KEY	PART NO.	PART NAME	QTY	REMARKS	
1	RE527858	SCREW	2	(Threads With Pre-Applied Sealant) M6 X 12	
2	RE539532	HEAT SHIELD	1	SUB FOR R522409; APPL	
3	H23125	PLUG	4		
4	R123574	NUT	1		
5	R123575	O-RING	1	7.595 X 2.616 mm	
6	R520896	VALVE COVER	1		
7	R524468	GASKET	1		
8	RE528742	DEFLECTOR	1		
9	19M7862	SCREW	1	M6 X 20	

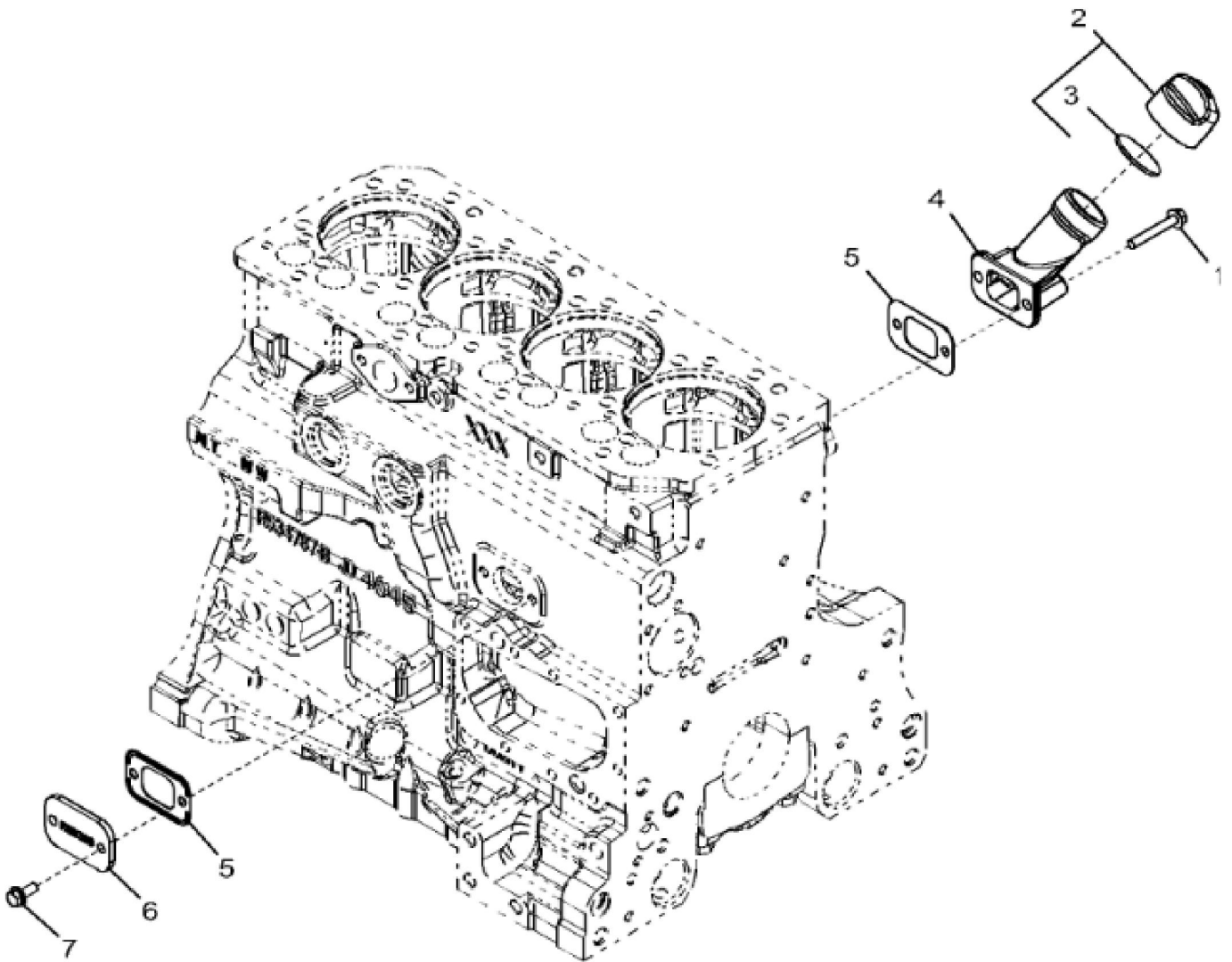

John Deere > Turf And Utility >TRACTOR >5090RN - TRACTOR >5090R, 5090RN Tractors (Europe Edition, Engine SN: CD4045LXXXXXX) >24 ENGINE 4045HL284-DD21703 >ST52635 - 1231 OIL FILLER NECK

KEY	PART NO.	PART NAME	QTY	REMARKS	
1	19M7979	SCREW	2	M8 X 55	
2	RE529554	FILLER CAP	1		
3	R80135	GASKET	1		
4	R532599	FILLER NECK	1	SUB FOR R521157	
5	R136495	GASKET	2		
6	R116296	COVER	1		
7	RE67238	SCREW	2	(Threads With Pre-Applied Sealant)	

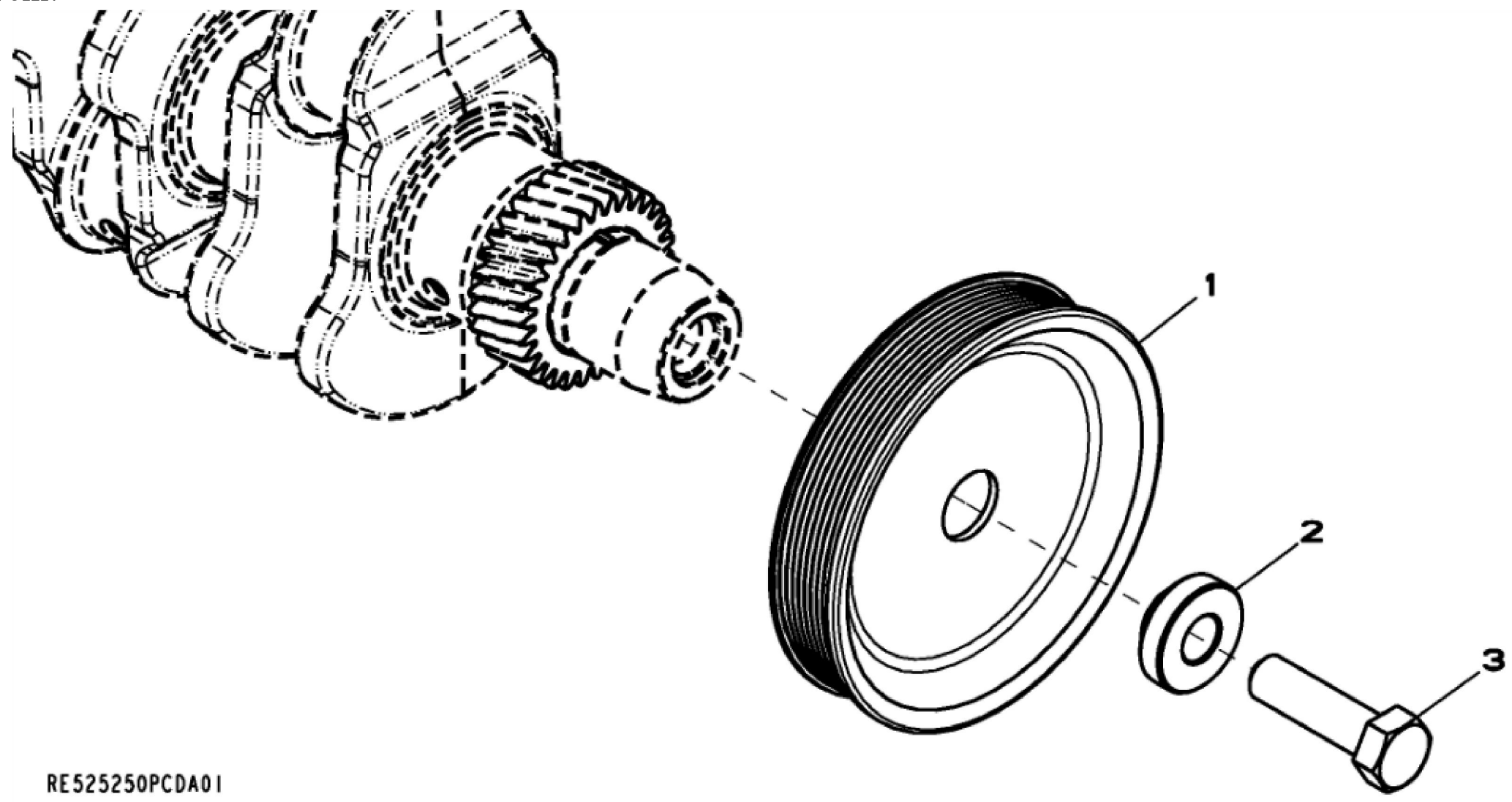

RE525250PCDA01

Thank you so much for reading.
Please click the “Buy Now!”
button below to download the
complete manual.



After you pay.

You can download the most
perfect and complete manual in
the world immediately.

Our support email:

ebooklibonline@outlook.com