

1118_RE506218_PCD

KEY	PART NO.	PART NAME	QTY	REMARKS	
1	H23125	PLUG	4		
2	R123574	NUT	4		
3	R123575	O-RING	4		
4	RE502969	VALVE COVER	1	MARKED R519779	
5	R524480	GASKET	1		

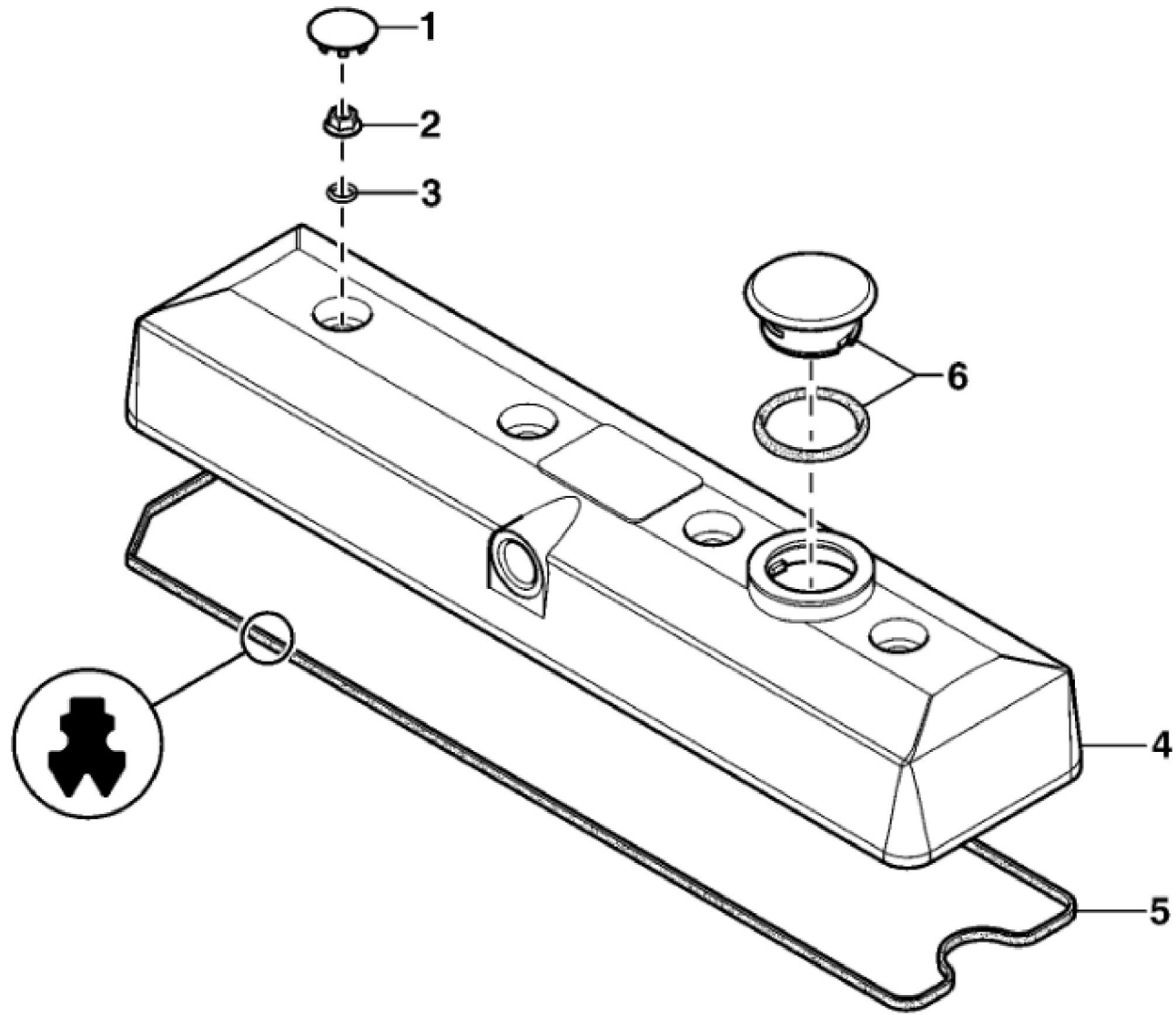

CDP46950A

John Deere > Turf And Utility >TRACTOR >5080M - TRACTOR >5080M Tractors (Europe Edition, Engine SN: CD4045LXXXXXX) >24 ENGINE 4045HL286-DD21688 >ST258811 - 1118 ROCKER ARM COVER - (CONVERSION PARTS)

KEY	PART NO.	PART NAME	QTY	REMARKS	
1	H23125	PLUG	4		
2	R123574	NUT	4		
3	R123575	O-RING	4		
4	RE70401	VALVE COVER	1	(Marked R519777)	
5	R524480	GASKET	1	(Sub For R123542)	
5	RE520539	GASKET KIT	AR	(Suitable For High Temperature, Include Instructions)	
6	RE59801	PLUG	1		

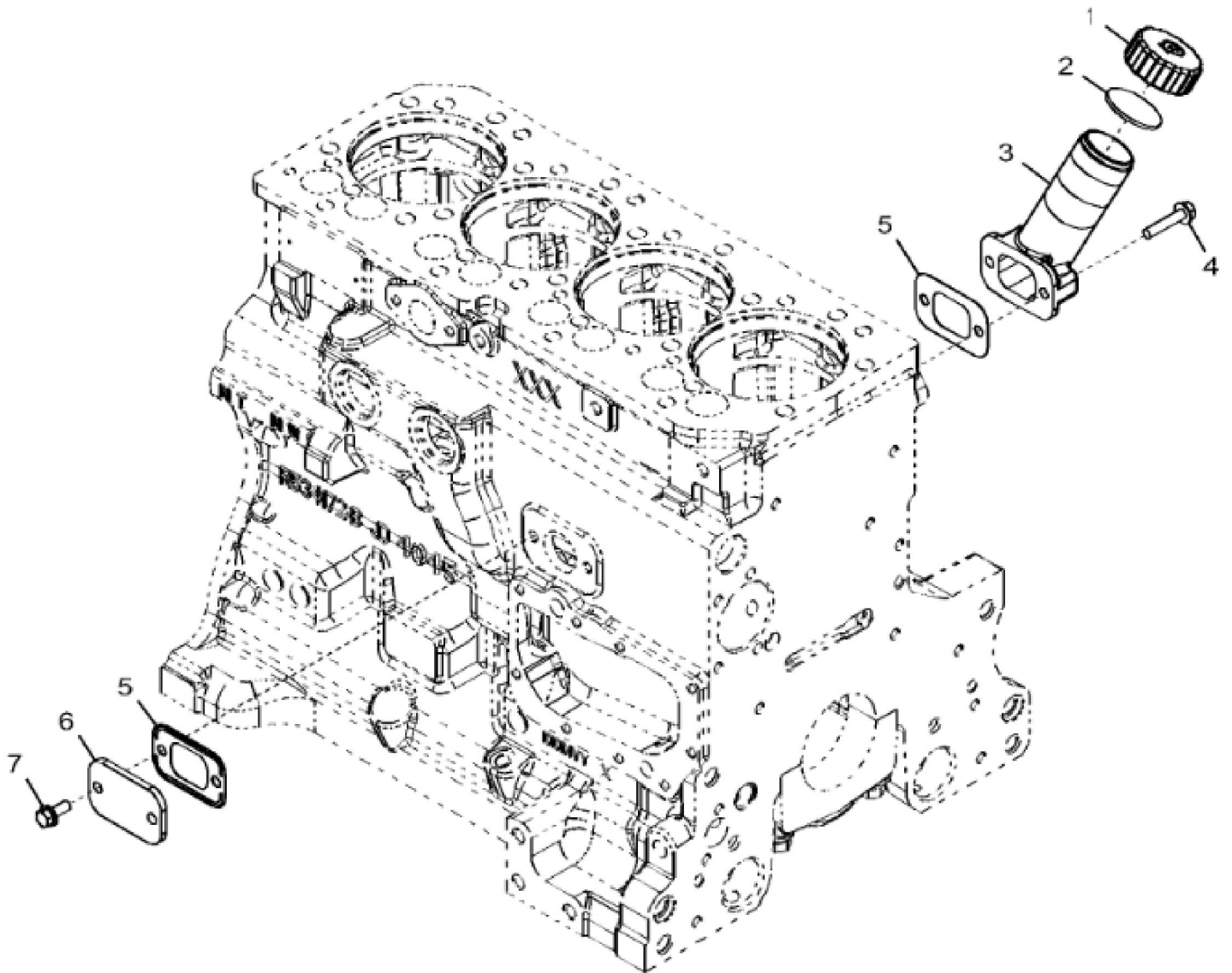

KEY	PART NO.	PART NAME	QTY	REMARKS	
1	R80136	FILLER CAP	1		
2	R80135	GASKET	1		
3	R517353	FILLER NECK	1		
4	19M7798	SCREW	2	M8 X 40	
5	R136495	GASKET	2		
6	R116296	COVER	1		
7	RE67238	SCREW	2	(Threads With Pre-Applied Sealant) M8 X 20	

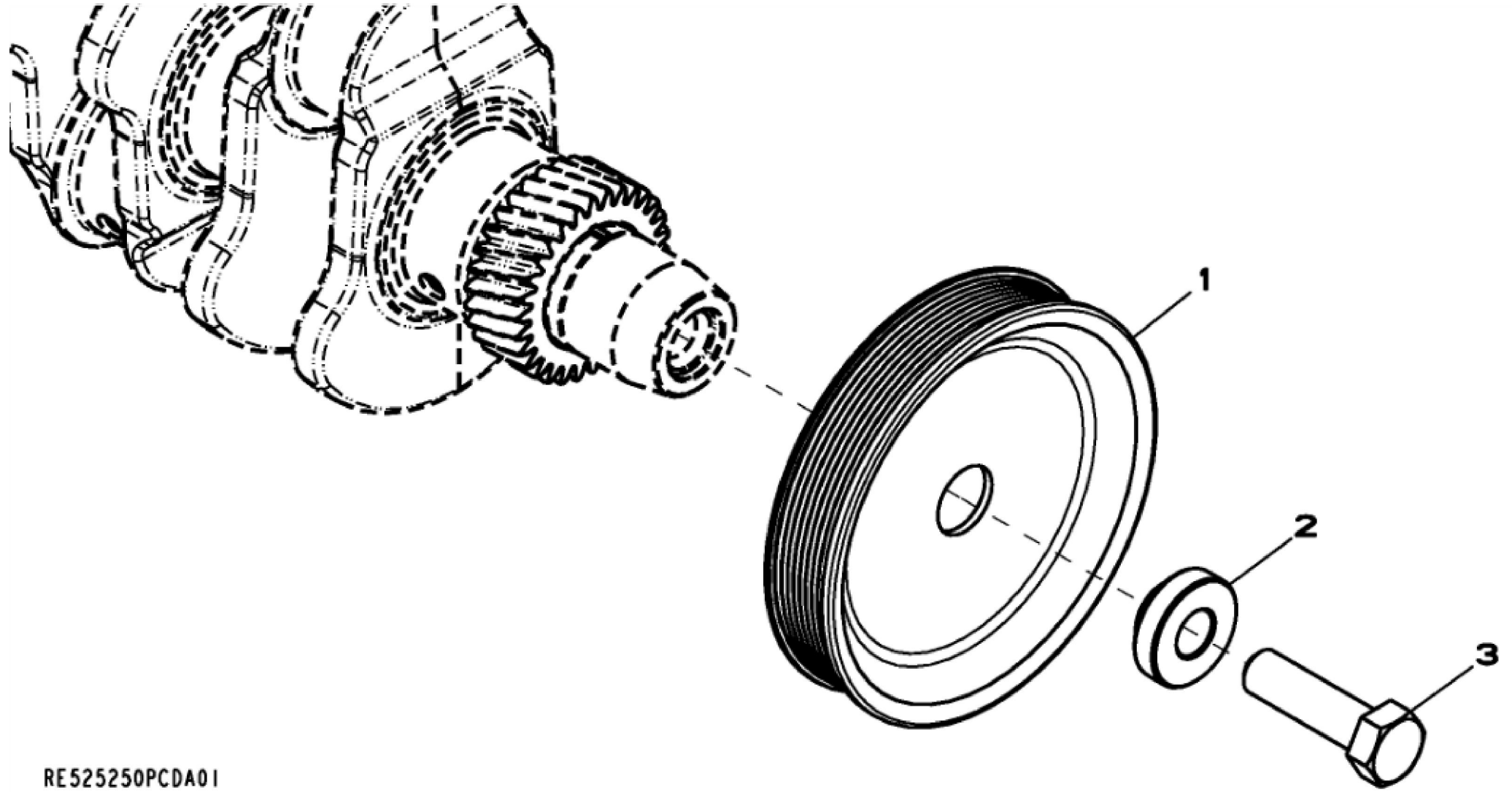

RE525250PCDA01

Thank you so much for reading.
Please click the “Buy Now!”
button below to download the
complete manual.



After you pay.

You can download the most
perfect and complete manual in
the world immediately.

Our support email:

ebooklibonline@outlook.com