

Section: ENGINE
CRANK CASE

Fig.	P/n	QTY	Name
------	-----	-----	------

Notes:
[AGROTRON 4.85]

1	04801770	1	crankcase WITH ITEM (2-8,10-16,18)
2	04156058	10	screw
3	04160764	10	bushing
4	01110423	1	screw DIN 000908-M14X1,5-ST-ZNPHRF
5	01118693	3	gasket 14x20 DIN 007603-A 14 X 20 -CU
6	01180890	1	screw H 002812-906-M30X1,5-ST-A4C-P RE80
7	01180906	1	screw H 002812-906-M22X1,5-ST-A4C-P RE80
8	01180891	2	screw H 002812-906-M14X1,5-ST-A4C-P RE80
10	04800319	4	bushing
11	04800318	1	bushing
12	01179635	6	plug H 002860-A45-ST-FE/ZNPHR
13	01179634	4	plug H 002860-A36-ST-FE/ZNPHR
14	01118960	2	plug am14x1,5 DIN 007604-AM14X1,5 -ST-ZNPHR
15	04800855	1	sleeve
16	01167270	2	bush H 002341-B15X18
18	01165790	1	plug m 22 x 1,5 H 000710-M22X1,5
185	01016127		sealing compound ml. 50 H 000699-DEUTZ DW 72- 50 ML



Kurbelgehäuse
Crankcase
Carter
Bloque de cilindros

Referenznr.: 05070612

0130 -01- 0507 1734

001

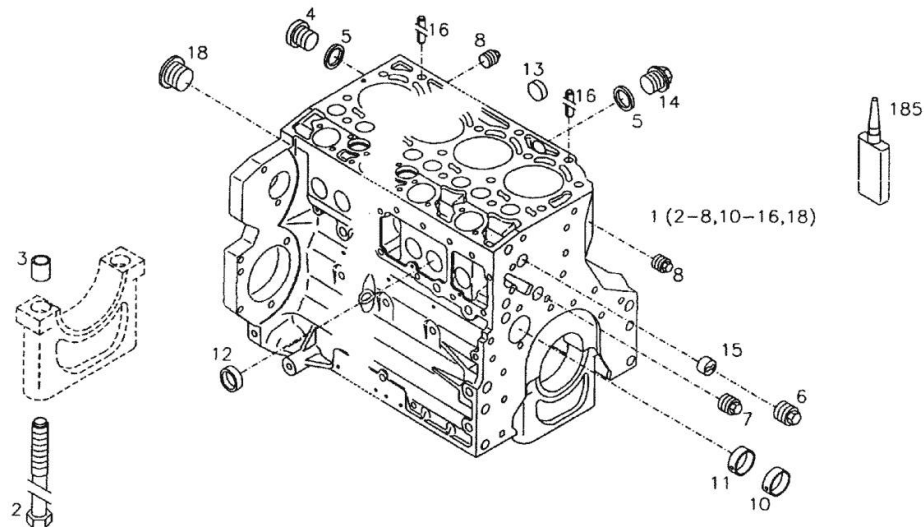

Section: ENGINE

PISTON COOL.NOZZLE

Fig.	P/n	QTY	Name
------	-----	-----	------

Notes:
[AGROTRON 4.85]

1	04801088	1	sprayer nozzle
---	----------	---	----------------



Kolbenkühlöse
Piston cooling nozzle
Gicleur de refroidissement de piston
Tobero de refrigeration de piston

Referenznr.:

0130 -01- 0507 0148

000

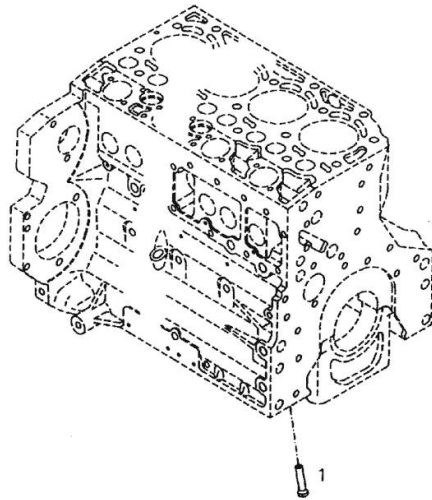

Section: ENGINE

CRANKCASE VENT

Fig.	P/n	QTY	Name
------	-----	-----	------

Notes:

[AGROTRON 4.85]

1	04800975	1	valve
3	01179292	2	screw H 002008-F-M 6 X 20- 10.9-A4C
4	04801350	1	rubber sleeve
5	01166476	1	clamp H 000735-SK 14
6	01178750	1	clamp H 003461-D29 -FED.ST
7	04801522	1	ring

 Kurbelgehäuseentlüftung
Crankcase breather
Reniflard
Desaireación de bloque

Referenznr.:

0130 -01- 0507 0430

002

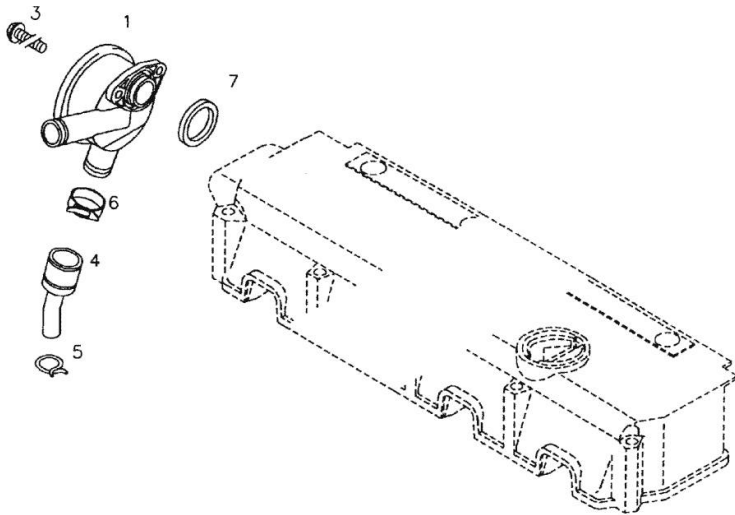

Section: ENGINE

CRANKCASE VENT

Fig.	P/n	QTY	Name
------	-----	-----	------

Notes:

[AGROTRON 4.85]

1	04800975	1	valve WITH ITEM (2)
2	04801522	1	ring
3	01179292	2	screw H 002008-F-M 6 X 20- 10.9-A4C
4	04801887	1	rubber sleeve



Kurbelgehäuseentlüftung
Crankcase breather
Reniflard
Desaireación de bloque

Referenznr.:

0130 -01- 0507 1876

001

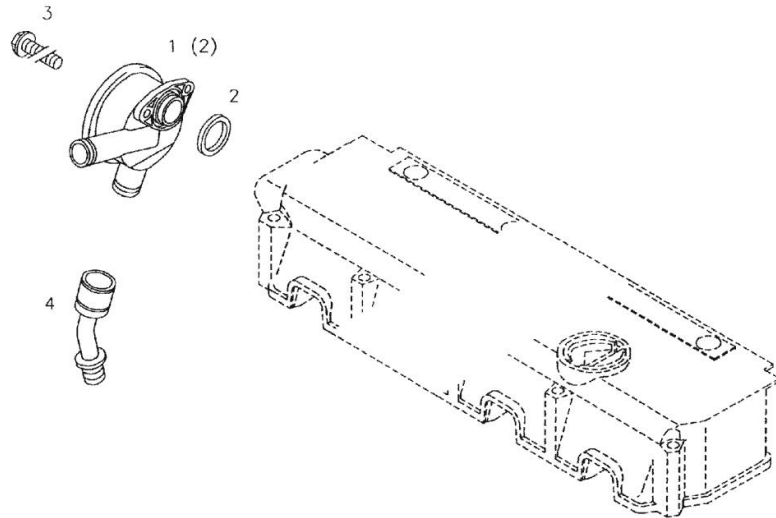

Section: ENGINE

BREATHER HOSE

Fig.	P/n	QTY	Name
------	-----	-----	------

Notes:

[AGROTRON 4.85]

1	04800551	1	flexible hose
2	01178750	3	clamp H 003461-D29 -FED.ST



Entlüftungsschlauch
Bleeding tube
Tube de la désaération
Manguera de desaireación

Referenznr.: 05070637

0130 -01- 0507 1689

001

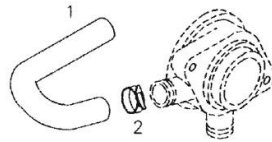

Section: ENGINE

FRONT COVER

Fig.	P/n	QTY	Name
------	-----	-----	------

Notes:
[AGROTRON 4.85]

1	04802292	1	cover
2	04800388	1	ring



Vorderer Deckel
Front cover
Couvercle avant
Tapa delantera

Referenznr.: 05070257

0130 -01- 0507 1462

000

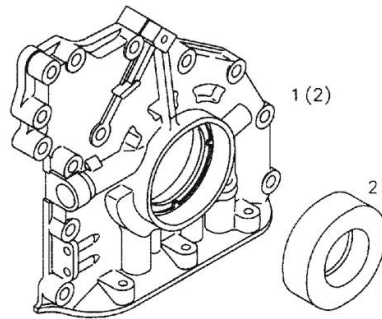

Section: ENGINE

FASTENINGS

Fig.	P/n	QTY	Name
------	-----	-----	------

Notes:

[AGROTRON 4.85]

3	04801195	1	gasket
4	01143362	12	screw H 002008-F-M 8 X 35- 10.9-A4C
5	01179794	1	bush H 002341-B11X 8



Befestigungsteile
Fastenings
Pieces de fixation
Piezas de fijacion

0130-01-0507 0272

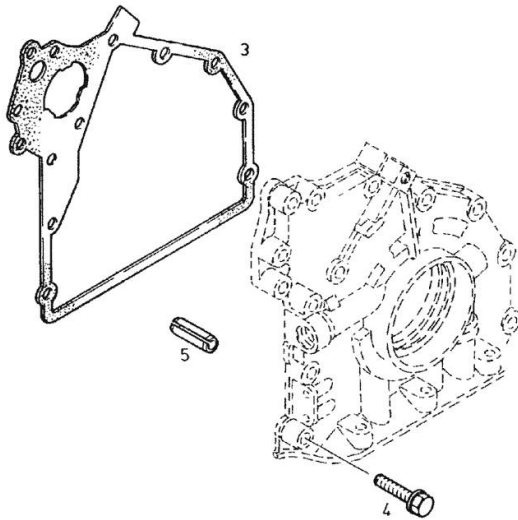

Buy Now



Our support email:

ebooklibonline@outlook.com