

320
322



Bobcat®

Service Manual

320 - S/N 223911001 & Above
322 - S/N 224011001 & Above
(G Series)

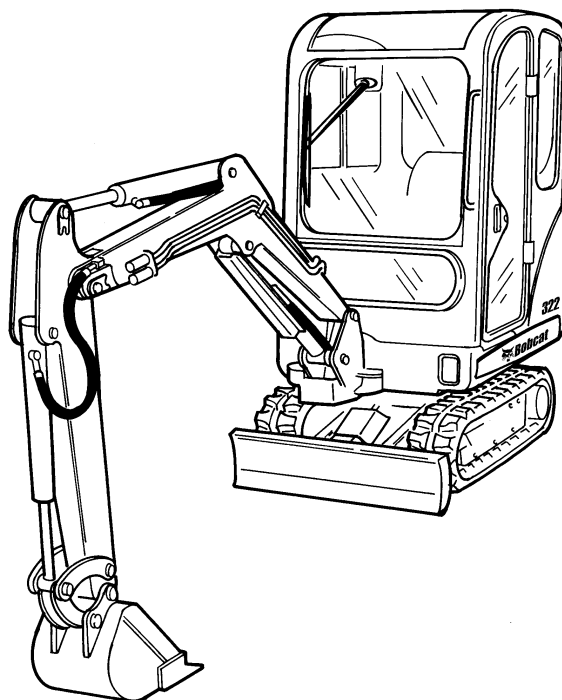

MAINTENANCE SAFETY



WARNING

Instructions are necessary before operating or servicing machine. Read and understand the Operation & Maintenance Manual, Operator's Handbook and signs (decals) on machine. Follow warnings and instructions in the manuals when making repairs, adjustments or servicing. Check for correct function after adjustments, repairs or service. Untrained operators and failure to follow instructions can cause injury or death.

W-2003-0903



Safety Alert Symbol: This symbol with a warning statement, means: "Warning, be alert! Your safety is involved!" Carefully read the message that follows.

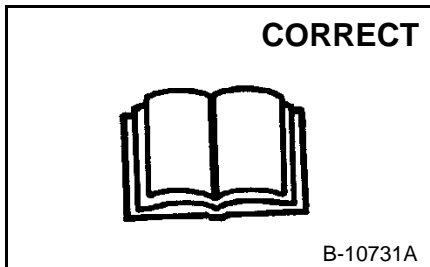

B-10731A

- ⚠ Never service the Bobcat Compact Excavator without instructions.

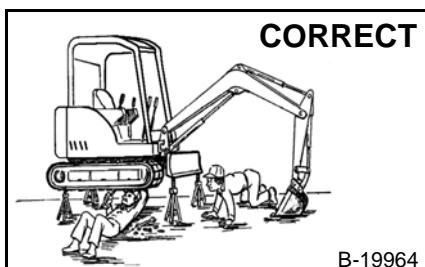

B-19964

- ⚠ Use the correct procedure to lift and support the excavator.

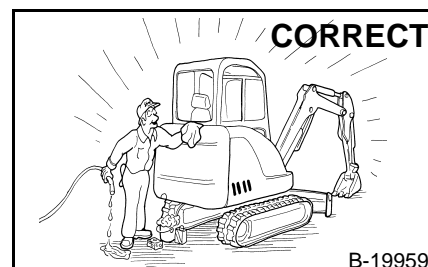

B-19959

- ⚠ Cleaning and maintenance are required daily.

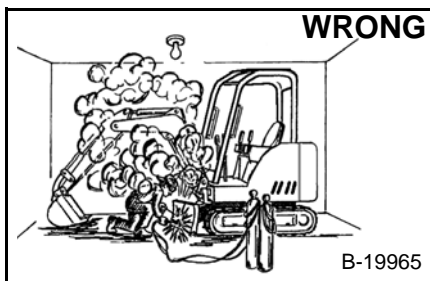

B-19965

- ⚠ Have good ventilation when welding or grinding painted parts.
- ⚠ Wear dust mask when grinding painted parts. Toxic dust and gas can be produced.

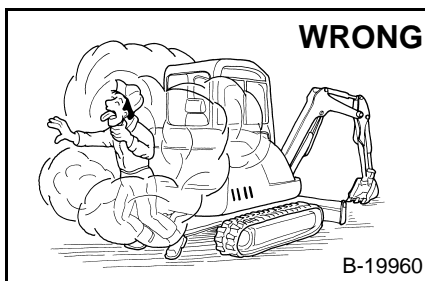

B-19960

- ⚠ Vent exhaust to outside when engine must be run for service.
- ⚠ Exhaust system must be tightly sealed. Exhaust fumes can kill without warning.

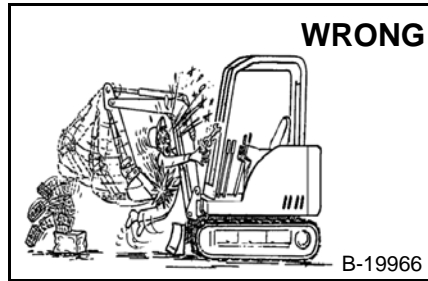

B-19966

- ⚠ Always lower the bucket and blade to the ground before doing any maintenance.
- ⚠ Never modify equipment or add attachments not approved by Bobcat Company.

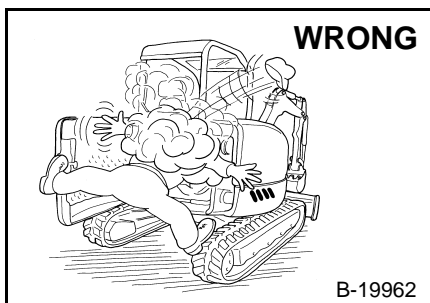

B-19962

- ⚠ Stop, cool and clean engine of flammable materials before checking fluids.
- ⚠ Never service or adjust machine with the engine running unless instructed to do so in the manual.
- ⚠ Avoid contact with leaking hydraulic fluid or diesel fuel under pressure. It can penetrate the skin or eyes.
- ⚠ Never fill fuel tank with engine running, while smoking, or when near open flame.

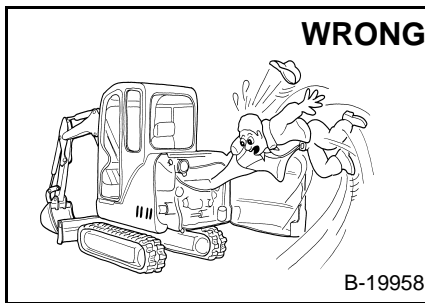

B-19958

- ⚠ Keep body, jewelry and clothing away from moving parts, electrical contact, hot parts and exhaust.
- ⚠ Wear eye protection to guard from battery acid, compressed springs, fluids under pressure and flying debris when engines are running or tools are used. Use eye protections approved for type of welding.
- ⚠ Keep tailgate closed except for service. Close and latch tailgate before operating the excavator.

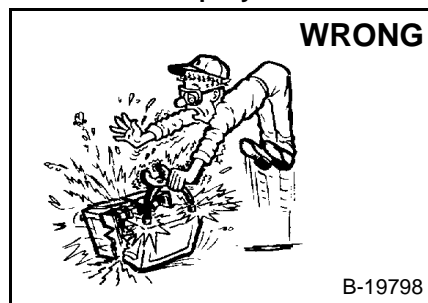

B-19798

- ⚠ Lead-acid batteries produce flammable and explosive gases.
- ⚠ Keep arcs, sparks, flames and lighted tobacco away from batteries.
- ⚠ Batteries contain acid which burns eyes or skin on contact.
- ⚠ Wear protective clothing. If acid contacts body, flush well with water. For eye contact flush well and get immediate medical attention.

Maintenance procedures which are given in the Operation & Maintenance Manual can be performed by the owner/operator without any specific technical training. Maintenance procedures which are **not** in the Operation & Maintenance Manual must be performed **ONLY BY QUALIFIED BOBCAT SERVICE PERSONNEL**. Always use genuine Bobcat replacement parts. The Service Safety Training Course is available from your Bobcat dealer.

MSW28-0805

ALPHABETICAL INDEX

AIR CLEANER	60-01	LEFT CONSOLE	40-01
AIRCLEANER SERVICE	10-01	LEFT CONTROL LEVER (JOYSTICK)	20-01
ALTERNATOR	50-01	LEFT PEDAL	40-01
ALTERNATOR BELT	10-01	LIFTING AND BLOCKING THE EXCAVATOR	10-01
ARM	40-01	LIFTING THE EXCAVATOR	10-01
ARM CYLINDER	20-01	LIGHTS.....	50-01
 		LUBRICATION OF THE HYDRAULIC EXCAVATOR	10-01
BATTERY	50-01	 	
BLADE	30-01	MAIN RELIEF VALVE	20-01
BLADE CONTROL.....	40-01	MANIFOLD ASSEMBLY/ACCUMULATOR.....	20-01
BLADE CYLINDER.....	20-01	MICROSWITCH	50-01
BLADE EXTENSION TRAY	40-01	 	
BOOM	40-01	OIL COOLER.....	20-01
BOOM CYLINDER.....	20-01	OPERATOR CAB (ROPS/TOPS).....	10-01
BOOM SWING CYLINDER.....	20-01	 	
BUCKET	40-01	PORT RELIEF VALVES	20-01
BUCKET CYLINDER	20-01	PRESSURE REDUCING VALVE	20-01
CAB.....	40-01	RADIATOR	60-01
CONTROL CONSOLE LOCKOUTS	10-01	RECONDITIONING THE ENGINE	60-01
CONTROL LINKAGE ASSEMBLY	40-01	RIGHT CONSOLE.....	40-01
CONTROL PATTERN SELECTOR VALVE.....	20-01	RIGHT CONTROL LEVER (JOYSTICK)	20-01
CONVERSIONS	SPEC-01	RIGHT PEDAL.....	40-01
CROSSPORT RELIEF VALVES.....	20-01	ROPS CANOPY.....	40-01
ELECTRICAL SYSTEM	50-01	SEAT AND SEAT MOUNT	40-01
ENGINE	60-01	SEAT BELT	10-01
ENGINE COMPONENTS AND TESTING	60-01	SERVICE SCHEDULE	10-01
ENGINE COOLING SYSTEM.....	10-01	SPARK ARRESTOR MUFFLER	10-01, 60-01
ENGINE FLYWHEEL.....	60-01	SPECIFICATIONS.....	SPEC-01
ENGINE LUBRICATION SYSTEM	10-01	STARTER.....	50-01
ENGINE SPECIFICATIONS	SPEC-01	SWING CIRCLE GEAR.....	30-01
ENGINE SPEED CONTROL	40-01	SWING FRAME.....	40-01
 		SWING LOCK.....	10-01, 40-01
FLOORMAT AND FLOORPLATES	40-01	SWING MOTOR	20-01
FUEL, COOLANT AND LUBRICANTS	SPEC-01	SWIVEL JOINT	20-01
FUEL LEVEL SENDER.....	50-01	 	
FUEL SYSTEM	10-01	TAILGATE	40-01
FUEL TANK	40-01	TORQUE SPECIFICATIONS	SPEC-01
 		TRACKS	30-01
HEATER VALVE.....	70-01	TRACK DAMAGE IDENTIFICATION	30-01
HEATER AIR FILTERS	10-01	TRACK FRAME	30-01
HEATER	70-01	TRACK IDLER.....	30-01
HORN	40-01	TRACK FRAME EXPANSION CYLINDER.....	20-01
HYDRAULIC CONNECTION SPECIFICATIONS	SPEC-01	TRACK ROLLER	30-01
HYDRAULIC CONTROL VALVE	20-01	TRANSPORTING THE EXCAVATOR.....	10-01
HYDRAULIC FILTER MOUNT.....	20-01	TRAVEL CONTROLS.....	40-01
HYDRAULIC FLUID SPECIFICATIONS.....	SPEC-01	TRAVEL MOTOR	10-01, 20-01
HYDRAULIC PUMP.....	20-01	TROUBLESHOOTING	60-01
HYDRAULIC RESERVOIR	20-01	TWO SPEED SWITCH.....	50-01
HYDRAULIC SYSTEM	10-01	 	
HYDRAULIC SYSTEM INFORMATION	20-01	UPPERSTRUCTURE	40-01

CONTENTS

FOREWORD.....	III
SAFETY INSTRUCTIONS	V
SERIAL NUMBER LOCATIONS.....	IX
DELIVERY REPORT.....	X
BOBCAT EXCAVATOR IDENTIFICATION.....	XI
SAFETY AND MAINTENANCE.....	10-01
HYDRAULIC SYSTEM	20-01
UNDERCARRIAGE.....	30-01
UPPERSTRUCTURE & SWING SECTION	40-01
ELECTRICAL SYSTEM AND ANALYSIS.....	50-01
ENGINE SERVICE	60-01
HEATER	vii
SPECIFICATIONS	SPEC-01

**SAFETY AND
MAINTENANCE**

**HYDRAULIC
SYSTEM**

**UNDER-
CARRIAGE**

**UPPER-
STRUCTURE &
SWING SECTION**

**ELECTRICAL
SYSTEM AND
ANALYSIS**

**ENGINE
SERVICE**

HEATER

SPECIFICATIONS

FOREWORD

This manual is for the Bobcat Hydraulic Excavator mechanic. It provides necessary servicing and adjustment procedures for the hydraulic Excavator and its component parts and systems. Refer to the Operation & Maintenance Manual for operating instructions, starting procedure, daily checks, etc.

A general inspection of the following items must be made after the hydraulic Excavator has had service or repair:

1. Check that ROPS/TOPS/FOPS is in good condition and is NOT modified.

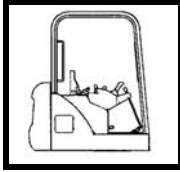

2. Check that ROPS/TOPS mounting hardware is tightened and is Bobcat approved.

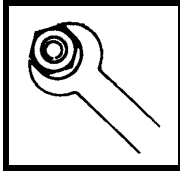

3. The seat belt must be correctly installed, functional and in good condition.

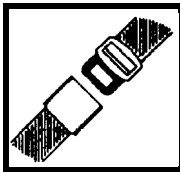

4. Inspect for loose or broken parts or connections.

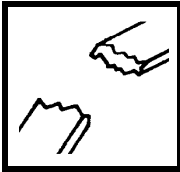

5. Machine signs must be legible and in the correct location.



6. Steering levers, control levers and foot pedals must return to neutral. Check that foot pedals lock and control lever locks are in working order.

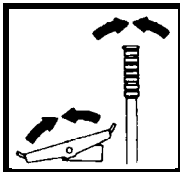

7. Inspect the air cleaner for damage or leaks. Check the condition of the filters.

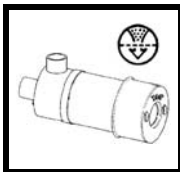

8. Check the electrical charging system.

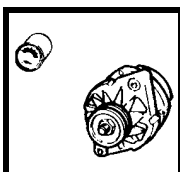

9. Safety treads must be in good condition.

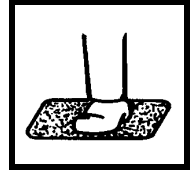

10. Check for correct function of indicator lamps (Optional on some models).

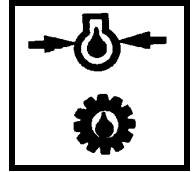

11. Check hydraulic fluid level, engine oil level and fuel supply.

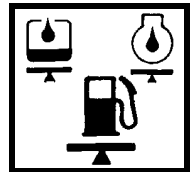

12. Inspect for fuel, oil or hydraulic fluid leaks.

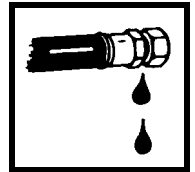

13. Lubricate the Excavator.

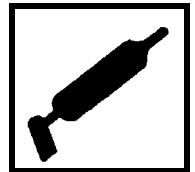

14. Check the condition of the battery and cables.

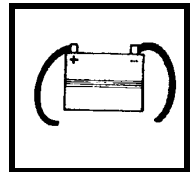

Recommend to the owner that all necessary corrections be made before the machine is returned to service.

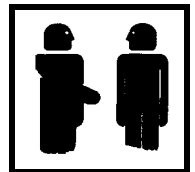

SAFETY INSTRUCTIONS (CONT'D)

Fire Prevention

The machine and attachments have components that are at high temperature under normal operating conditions. The primary source of high temperatures is the engine and exhaust system. The electrical system, if damaged or incorrectly maintained, can be a source of arcs or sparks.

Flammable debris (leaves, straw, etc.) must be removed regularly. If flammable debris is allowed to accumulate, it will increase fire hazard. Clean often to avoid this accumulation. Flammable debris in the engine compartment is a potential hazard.

The spark arrestor muffler is designed to control the emission of hot particles from the engine and exhaust system, but the muffler and the exhaust gases are still hot.

- Do not use the machine where exhaust, arcs, sparks or hot components can contact flammable material, explosive dust or gases.
- The operator cab, engine compartment, and engine cooling system must be inspected every day and cleaned if necessary to prevent fire hazard and overheating.
- Check all electrical wiring and connections for damage. Keep the battery terminals clean and tight. Repair or replace any damaged part.
- Check fuel and hydraulic tubes, hoses and fittings for damage and leakage. Never use open flame or bare skin to check for leaks. Tighten or replace any parts that show leakage. Always clean fluid spills. Do not use gasoline or diesel fuel for cleaning parts. Use commercial nonflammable solvents.
- Do not use ether or starting fluids on any engine which has glow plugs. These starting aids can cause explosion and injure you or bystanders.
- Always clean the machine, disconnect the battery, and disconnect the wiring from the controllers before welding. Cover rubber hoses, battery and all other flammable parts. Keep a fire extinguisher near the machine when welding. Have good ventilation when grinding or welding painted parts. Wear a dust mask when grinding painted parts. Toxic dust or gas can be produced.
- Stop the engine and let it cool before adding fuel. **NO SMOKING!**

- Use the procedure in the Operation & Maintenance Manual for connecting the battery and for jump starting.
- Use the procedure in the Operation & Maintenance Manual for cleaning the spark arrestor muffler (if equipped).

Figure 1

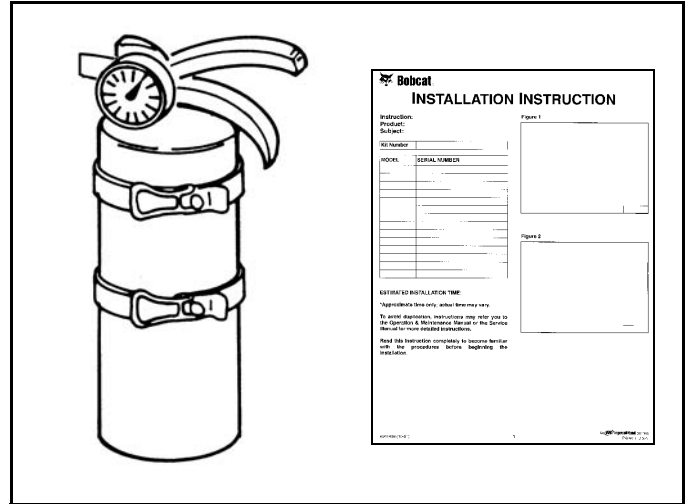

- Know where fire extinguishers and first aid kits are located and how to use them. Fire extinguishers are available from your Bobcat dealer [Figure 1].

SERIAL NUMBER LOCATIONS

Always use the serial number of the Excavator when requesting service information or when ordering parts. Early or later models (identification made by serial number) may use different parts, or it may be necessary to use a different procedure in doing a specific service operation.

Excavator Serial Number

Figure 1

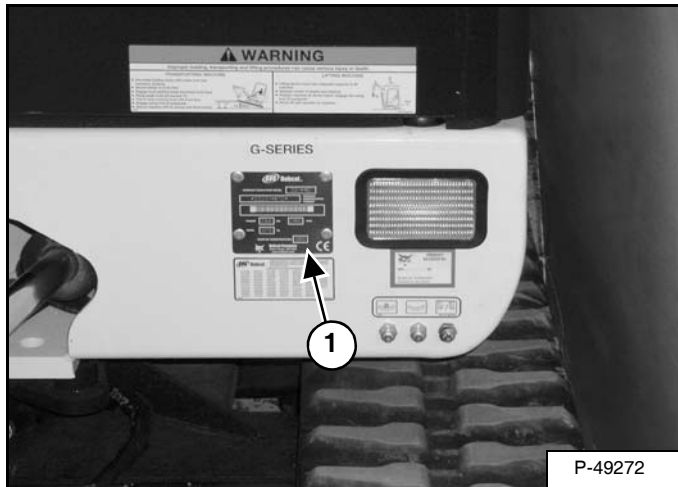

The Excavator serial number plate (Item 1) is located on the frame of the machine in the location shown [Figure 1].

Explanation of Excavator Serial Number:

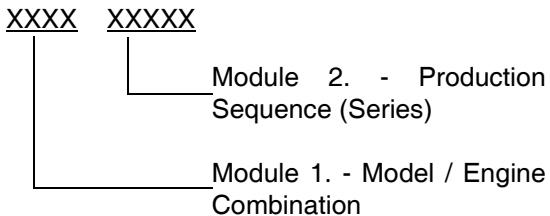

1. The four digit Model/Engine Combination Module number identifies the model number and engine combination.

2. The five digit Production Sequence Number identifies the order which the Excavator is produced.

Engine Serial Number

Figure 2

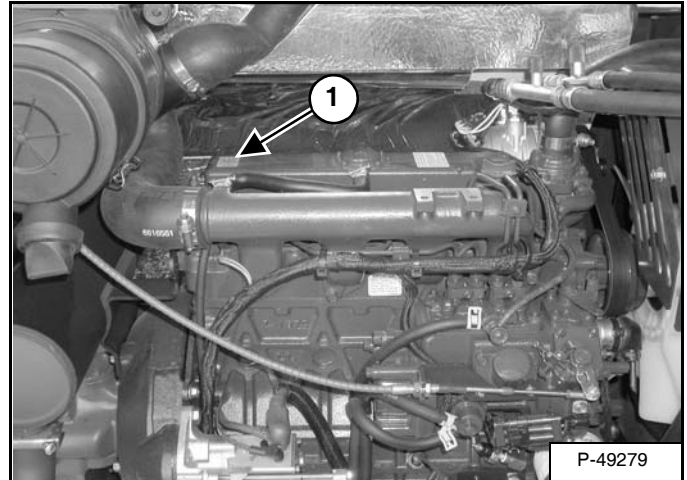
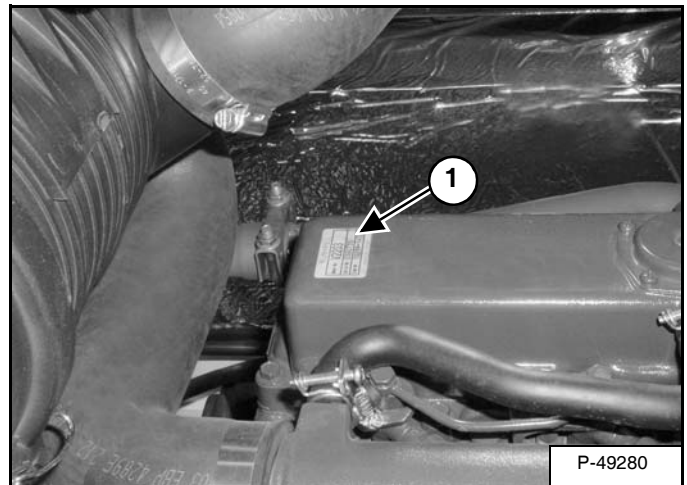

Figure 3



The engine serial number (Item 1) [Figure 2] & [Figure 3] is located on the engine in the locations shown.

DELIVERY REPORT

Figure 4

The diagram shows a form titled "DELIVERY REPORT". The form is divided into several sections. At the top, there is a header section with the title "DELIVERY REPORT". Below this, there are two columns of horizontal lines representing text input fields. On the left side, there is a section with a dark header containing the word "WARNING" in white capital letters, followed by several lines of text. At the bottom right of the form, there is a small rectangular box containing the alphanumeric code "B-16315".

The delivery report must be filled out by the dealer and signed by the owner or operator when the Bobcat Excavator is delivered. An explanation of the form must be given to the owner. Make sure it is filled out completely **[Figure 4]**.

BOBCAT EXCAVATOR IDENTIFICATION

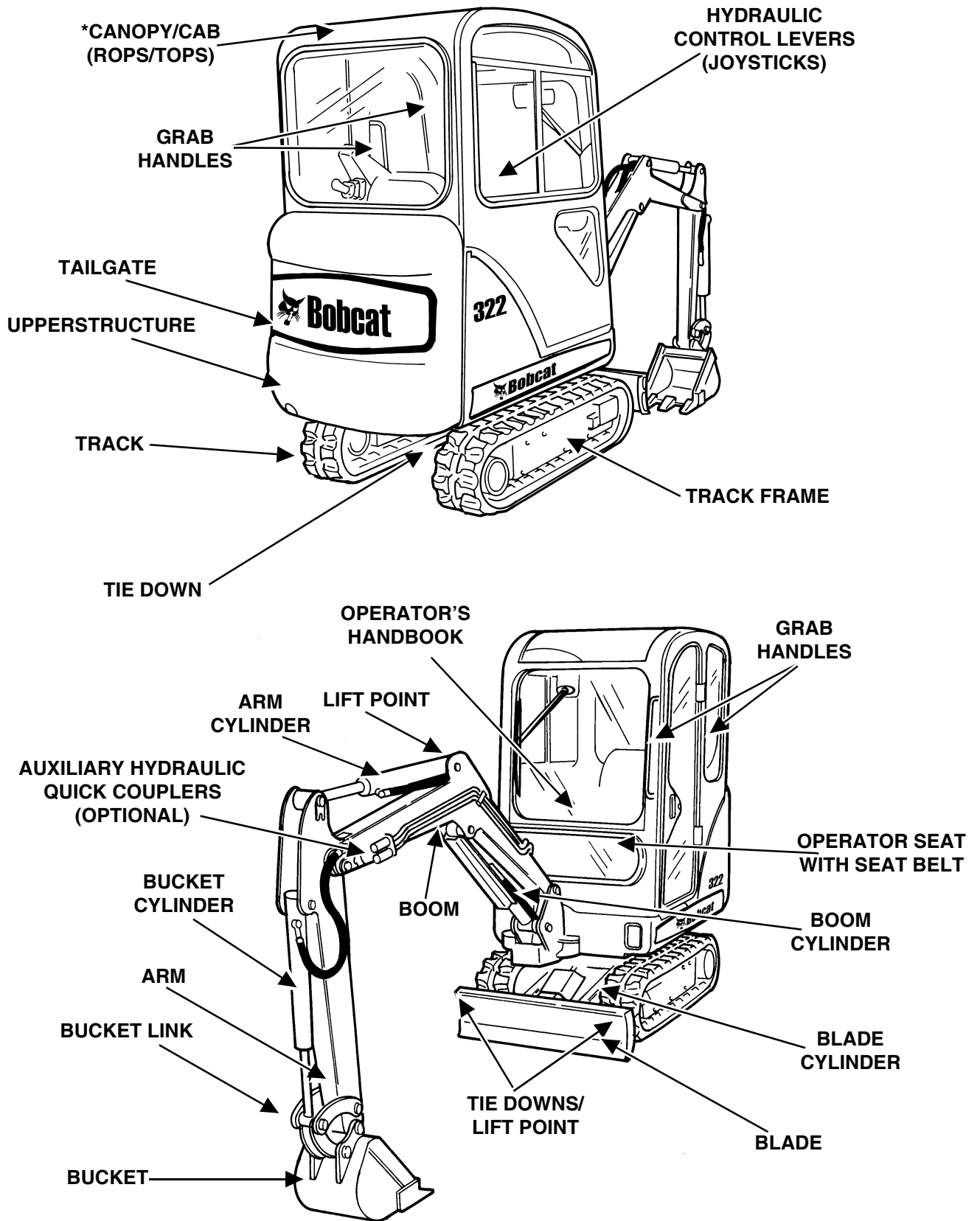

* FOGS (Falling Object Guards) is available from your Bobcat Excavator dealer.

B-23067
B-23066

AIR CLEANER SERVICE	10-60-1
Daily Check	10-60-1
Replacing The Filters	10-60-1
ALTERNATOR BELT	10-140-1
Adjusting The Alternator Belt	10-140-1
CONTROL CONSOLE LOCKOUTS	10-160-1
Inspection And Maintenance	10-160-1
ENGINE COOLING SYSTEM	10-70-1
Checking Coolant Level	10-70-1
Cleaning The Cooling System	10-70-1
Replacing The Coolant	10-70-2
ENGINE LUBRICATION SYSTEM	10-90-1
Checking Engine Oil	10-90-1
Oil Chart	10-90-1
Replacing Oil And Filter	10-90-2
FUEL SYSTEM	10-80-1
Draining The Fuel Tank	10-80-3
Filling The Fuel Tank	10-80-1
Fuel Specifications	10-80-1
Removing Air From The Fuel System	10-80-3
Removing Water From The Fuel Filter	10-80-2
Replacing The Fuel Filter	10-80-2
HEATER AIR FILTERS	10-61-1
Fresh Air Filter	10-61-1
Recirculation Filter	10-61-1
HYDRAULIC SYSTEM	10-100-1
Checking And Adding Hydraulic Oil	10-100-1
Diagnostic Couplers	10-100-1
Replacing Hydraulic Oil	10-100-2
Replacing The Hydraulic Filter	10-100-2
LIFTING AND BLOCKING THE EXCAVATOR	10-10-1
Procedure	10-10-1
LIFTING THE EXCAVATOR	10-12-1
LUBRICATION OF THE HYDRAULIC EXCAVATOR	10-110-1

Continued On Next Page

SAFETY AND MAINTENANCE (CONT'D)

OPERATOR CAB ROPS/TOPS	10-20-1
Cab Door	10-20-1
Emergency Exits	10-20-1
Front Window	10-20-2
Right Side Windows	10-20-4
SEAT BELT	10-150-1
Inspection And Maintenance	10-150-1
SERVICE SCHEDULE	10-50-1
Chart	10-50-1
SPARK ARRESTOR MUFFLER	10-130-1
SWING LOCK	10-11-1
TAILGATE	10-40-1
Adjusting The Bumper	10-40-1
Adjusting The Tailgate Latch	10-40-1
Opening And Closing The Tailgate	10-40-1
TRANSPORTING THE EXCAVATOR	10-30-1
TRAVEL MOTOR	10-120-1
Checking Oil Level	10-120-1
Draining The Travel Motor	10-120-1

LIFTING AND BLOCKING THE EXCAVATOR

Procedure

Always park the machine on a level surface.

Figure 10-10-1

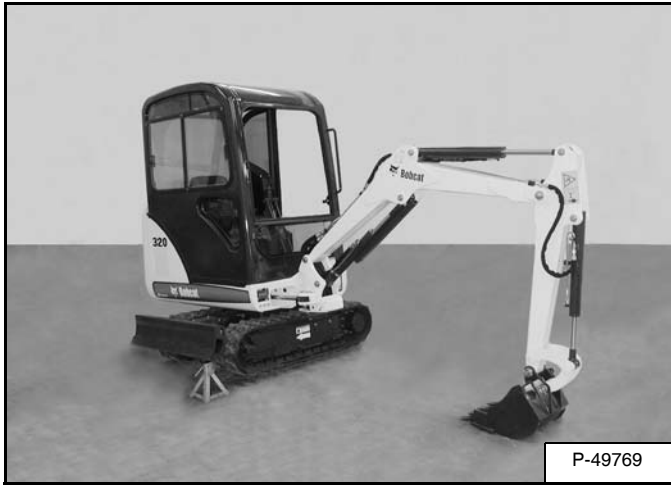

Raise one side of the machine (approximately 4 inches) using the boom and arm as shown in **[Figure 10-10-1]**.

Raise the blade fully and install jackstands under the blade and the track frame. Lower the machine until all machine weight is on the jackstands.

Stop the engine.

WARNING

Put jackstands under the blade and rear corners of the undercarriage before working under the machine. Failure to block up the machine may allow it to move or fall and result in injury or death

W-2218-1195

WARNING

AVOID INJURY OR DEATH

Keep fingers and hands out of pinch points when checking the track tension.

W-2142-0189

SWING LOCK

Figure 10-11-2

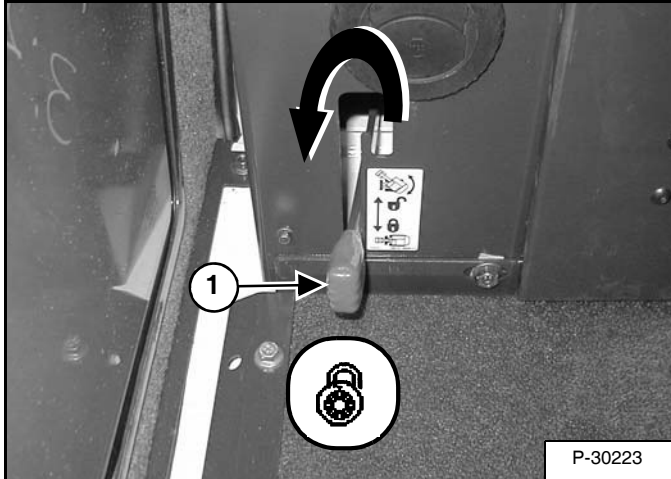

Move the lever (Item 1) [Figure 10-11-2] *down* to engage the Slew Lock. When the Slew Lock is engaged (locked), the upperstructure of the Excavator is locked to the track frame and will not rotate. The upper structure must be parallel to the track frame to engage the Slew Lock.

Figure 10-11-3

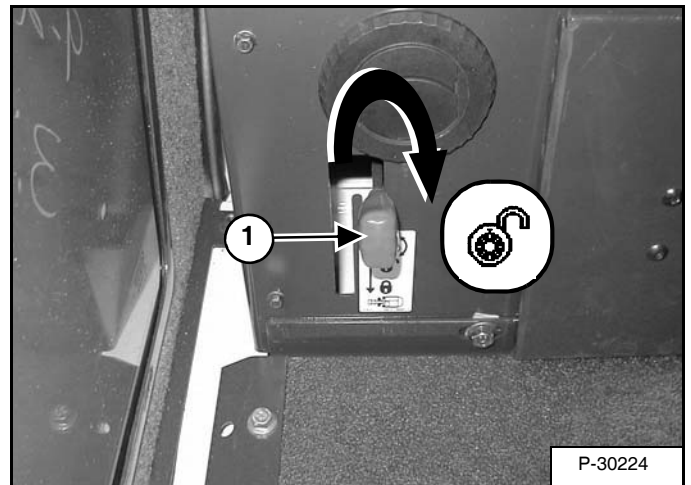

Move the lever (Item 1) [Figure 10-11-3] *up* to disengage the upperstructure from the track frame. Secure the lever in the unlocked position.

 **WARNING**

AVOID INJURY

The slew lock lever must be engaged when transporting the machine.

W-2197-1203

LIFTING THE EXCAVATOR

Figure 10-12-4

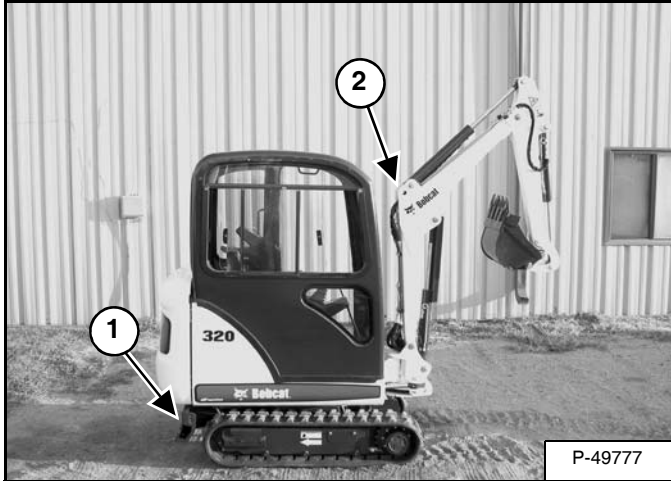

Fully extend the cylinders of the bucket, arm, and boom so that the Excavator is in the position as shown [Figure 10-12-4].

Engage the upperstructure slew lock. (See SWING LOCK on Page 10-11-1.)

Raise the blade all the way.

Put all the control levers in neutral.



AVOID INJURY OR DEATH

- Use a lifting fixture with sufficient capacity for the weight of the Excavator plus any added attachments.
- Maintain center of gravity and balance when lifting.
- Do not swing boom or upperstructure. Engage the slew locking lever.
- Never lift with operator on machine.

W-2202-0595

Figure 10-12-5

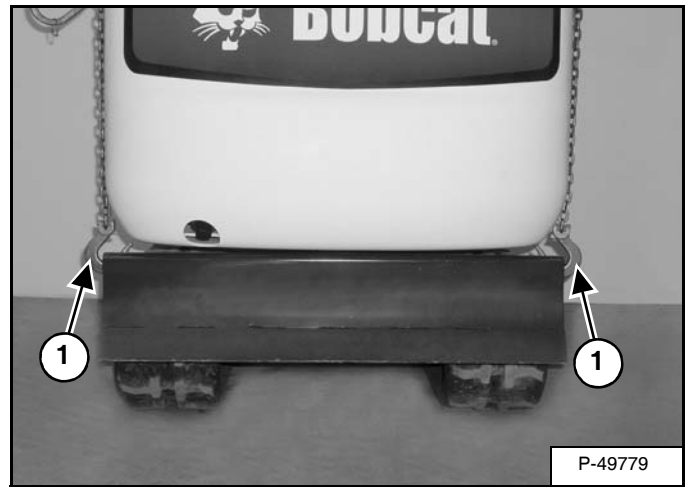

Fasten chains to the ends of the blade (Item 1) [Figure 10-12-4] and [Figure 10-12-5] and up to a lifting fixture above the canopy/cab. The lifting fixture must extend over the sides of the canopy/cab to prevent the chains from hitting the ROPS/TOPS.

Figure 10-12-6

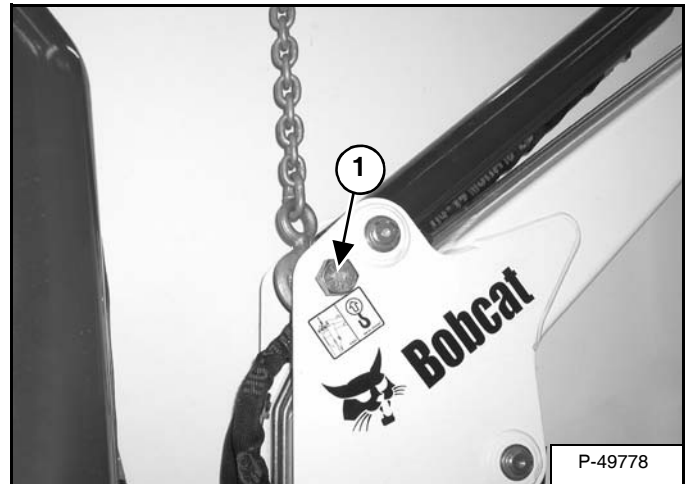

Install a one inch (25 mm) bolt and nut (Grade 5 or 8) through the holes at the boom (Item 1) [Figure 10-12-4] and [Figure 10-12-6]. Fasten a chain from the bolt to the lift fixture.

Thank you so much for reading.
Please click the “Buy Now!”
button below to download the
complete manual.



After you pay.

You can download the most
perfect and complete manual in
the world immediately.

Our support email:

ebooklibonline@outlook.com