

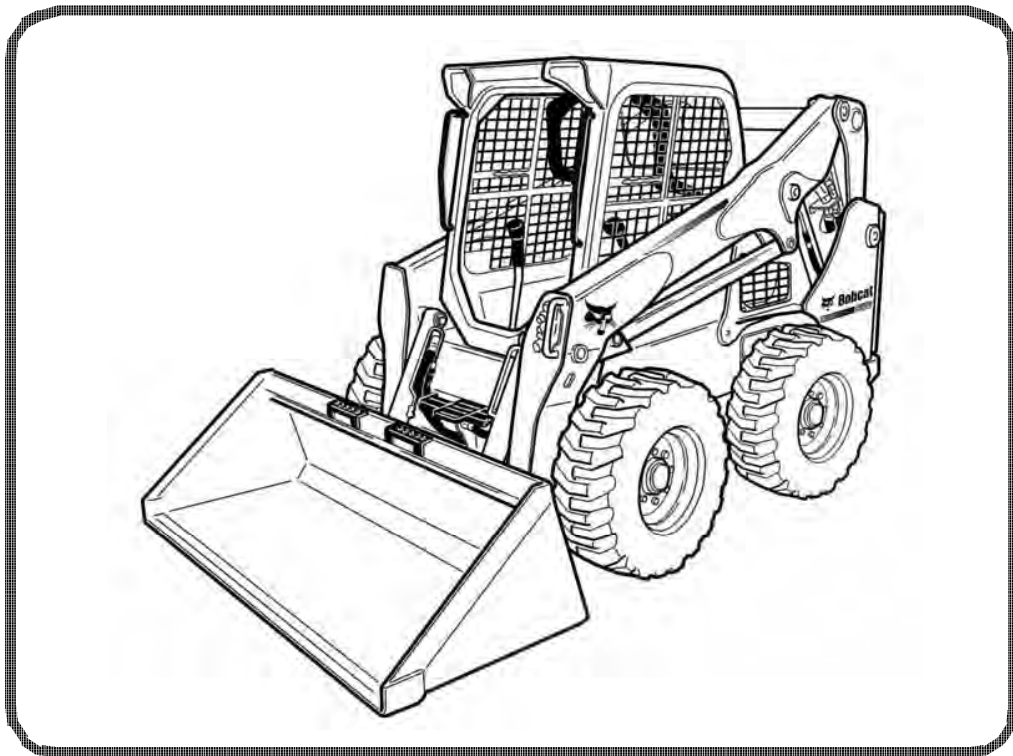

Service Manual

S590 Skid-Steer Loader

S/N AR9R11001 & Above
S/N B3H111001 & Above



EQUIPPED WITH
BOBCAT INTERLOCK
CONTROL SYSTEM (BICS™)



MAINTENANCE SAFETY



WARNING

Instructions are necessary before operating or servicing machine. Read and understand the Operation & Maintenance Manual, Operator's Handbook and signs (decals) on machine. Follow warnings and instructions in the manuals when making repairs, adjustments or servicing. Check for correct function after adjustments, repairs or service. Untrained operators and failure to follow instructions can cause injury or death.

W-2003-0807



Safety Alert Symbol: This symbol with a warning statement, means: "Warning, be alert! Your safety is involved!" Carefully read the message that follows.

CORRECT

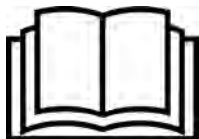

P-90216

- Never service the Bobcat Skid-Steer Loader without instructions.

CORRECT

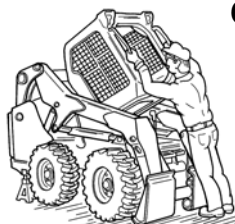

NA1694

- Use the correct procedure to lift or lower operator cab.

CORRECT



NA1693

- Cleaning and maintenance are required daily.

WRONG



NA1674

- Have good ventilation when welding or grinding painted parts.
- Wear dust mask when grinding painted parts. Toxic dust and gas can be produced.
- Avoid exhaust fume leaks which can kill without warning. Exhaust system must be tightly sealed.

WRONG

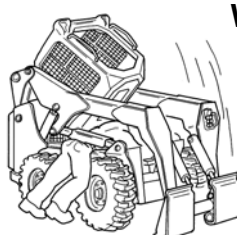

NA1695

- Disconnecting or loosening any hydraulic tubeline, hose, fitting, component or a part failure can cause lift arms to drop. Do not go under lift arms when raised unless supported by an approved lift arm support device. Replace it if damaged.

WRONG

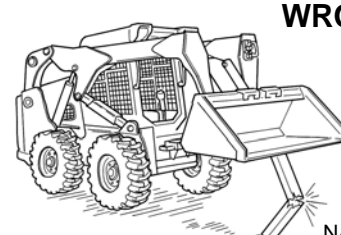

NA1680

- Never work on loader with lift arms up unless lift arms are held by an approved lift arm support device. Replace if damaged.
- Never modify equipment or add attachments not approved by Bobcat Company.

WRONG



NA1682

- Stop, cool and clean engine of flammable materials before checking fluids.
- Never service or adjust loader with the engine running unless instructed to do so in the manual.
- Avoid contact with leaking hydraulic fluid or diesel fuel under pressure. It can penetrate the skin or eyes.
- Never fill fuel tank with engine running, while smoking or when near open flame.

WRONG



NA1683

- Keep body, jewelry and clothing away from moving parts, electrical contact, hot parts and exhaust.
- Wear eye protection to guard from battery acid, compressed springs, fluids under pressure and flying debris when engines are running or tools are used. Use eye protection approved for type of welding.
- Keep rear door closed except for service. Close and latch door before operating the loader.

WRONG



B-6589

- Lead-acid batteries produce flammable and explosive gases.
- Keep arcs, sparks, flames and lighted tobacco away from batteries.
- Batteries contain acid which burns eyes or skin on contact.
- Wear protective clothing. If acid contacts body, flush well with water. For eye contact flush well and get immediate medical attention.

Maintenance procedures which are given in the Operation & Maintenance Manual can be performed by the owner/operator without any specific technical training. Maintenance procedures which are **not** in the Operation & Maintenance Manual must be performed **ONLY BY QUALIFIED BOBCAT SERVICE PERSONNEL**. Always use genuine Bobcat replacement parts. The Service Safety Training Course is available from your Bobcat dealer.

MSW39-0609

CONTENTS

SAFETY AND MAINTENANCE	10-01
HYDRAULIC SYSTEM	20-01
HYDROSTATIC SYSTEM	30-01
DRIVE SYSTEM	40-01
MAINFRAME	50-01
ELECTRICAL SYSTEM AND ANALYSIS	60-01
ENGINE SERVICE	70-01
HEATING, VENTILATION AND AIR CONDITIONING (HVAC)	80-01
SPECIFICATIONS	SPEC-01
ALPHABETICAL INDEX	INDEX-01







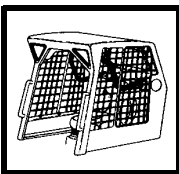
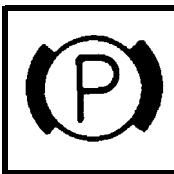

FOREWORD

FOREWORD	1-7
SAFETY INSTRUCTIONS	1-9
FIRE PREVENTION	1-11
Maintenance	1-11
Operation	1-11
Electrical	1-11
Hydraulic System	1-11
Fueling	1-11
Starting	1-11
Spark Arrester Exhaust System	1-11
Welding And Grinding	1-12
Fire Extinguishers	1-12
SERIAL NUMBER LOCATIONS	1-13
Loader Serial Number	1-13
Engine Serial Number	1-13
DELIVERY REPORT	1-14
LOADER IDENTIFICATION	1-15

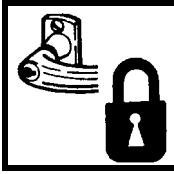
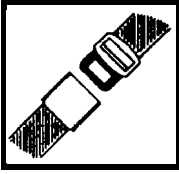
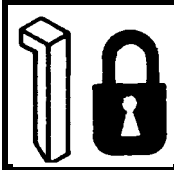
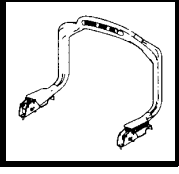
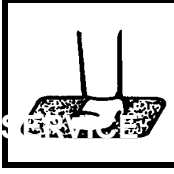
FOREWORD

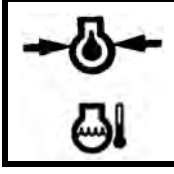
This manual is for the Bobcat loader mechanic. It provides necessary servicing and adjustment procedures for the Bobcat loader and its component parts and systems. Refer to the Operation & Maintenance Manual for operating instructions, starting procedure, daily checks, etc.

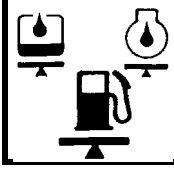
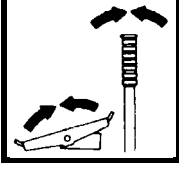
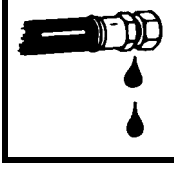
A general inspection of the following items must be made after the loader has had service or repair:

- | | | | |
|------------------------------------------------------------------------------------------------|-------------------------------------------------------------------------------------|-------------------------------------------------------------------------------------|---------------------------------------------------------------------------------------|
| 1. Check that the ROPS/FOPS (Including side screens) is in good condition and is not modified. |  | 9. The parking brake must function correctly. |  |
| 2. Check that ROPS mounting hardware is tightened and is Bobcat approved. |  | 10. Enclosure door latches must open and close freely. |  |
| 3. The seat belt must be correctly installed, functional and in good condition. |  | 11. Bob-Tach® wedges and linkages must function correctly and be in good condition. |  |
| 4. The seat bar must be correctly adjusted, clean and lubricated. |  | 12. Safety treads must be in good condition. |  |
| 5. Check lift arm support device, replace if damaged. |  | 13. Check for correct function of indicator lamps. |  |
| 6. Machine signs (decals) must be legible and in the correct location. |  | 14. Check hydraulic fluid level, engine oil level and fuel supply. |  |
| 7. Steering levers, hand controls and foot pedals must return to neutral (as applicable). |  | 15. Inspect for fuel, oil or hydraulic fluid leaks. |  |
| 8. Check for correct function of the work lights. |  | 16. Lubricate the loader. |  |

FW SSL-0517 SM

17. Check the condition of the battery and cables.

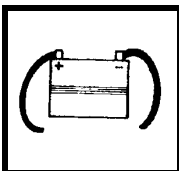

18. Inspect the air cleaner for damage or leaks. Check the condition of the element.

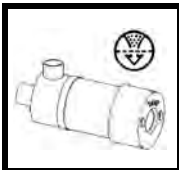

19. Check the electrical charging system.

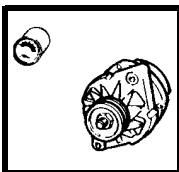

20. Check tires for wear and pressure. Check tracks for wear and tension. Use only approved tires or tracks.



21. Inspect for loose or broken parts or connections.



22. Check for any field modification not completed.



23. Operate the machine and check all functions.



24. Check for correct function of the Bobcat Interlock Control System (BICS™) before the machine is returned to the customer.



25. Check for proper function of front horn and back-up alarm (if equipped).



26. Check function or condition of all equipped options and accessories (examples: fire extinguisher, rotating beacon, lift kits, etc.).



27. Recommend to the owner that all necessary corrections be made before the machine is returned to service.

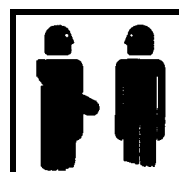

CALIFORNIA
PROPOSITION 65 WARNING
 Diesel engine exhaust and some of its constituents are known to the state of California to cause cancer, birth defects and other reproductive harm.

FIRE PREVENTION



Maintenance

The machine and some attachments have components that are at high temperatures under normal operating conditions. The primary source of high temperatures is the engine and exhaust system. The electrical system, if damaged or incorrectly maintained, can be a source of arcs or sparks.

Flammable debris (leaves, straw, etc.) must be removed regularly. If flammable debris is allowed to accumulate, it can cause a fire hazard. Clean often to avoid this accumulation. Flammable debris in the engine compartment is a potential fire hazard.

The operator's area, engine compartment and engine cooling system must be inspected every day and cleaned if necessary to prevent fire hazards and overheating.

All fuels, most lubricants and some coolants mixtures are flammable. Flammable fluids that are leaking or spilled onto hot surfaces or onto electrical components can cause a fire.

Operation

Do not use the machine where exhaust, arcs, sparks or hot components can contact flammable material, explosive dust or gases.

Electrical



Check all electrical wiring and connections for damage. Keep the battery terminals clean and tight. Repair or replace any damaged part or wires that are loose or frayed.

Battery gas can explode and cause serious injury. Use the procedure in the Operation & Maintenance Manual for connecting the battery and for jump starting. Do not jump start or charge a frozen or damaged battery. Keep any open flames or sparks away from batteries. Do not smoke in battery charging area.

Hydraulic System

Check hydraulic tubes, hoses and fittings for damage and leakage. Never use open flame or bare skin to check for leaks. Hydraulic tubes and hoses must be properly routed and have adequate support and secure clamps. Tighten or replace any parts that show leakage.

Always clean fluid spills. Do not use gasoline or diesel fuel for cleaning parts. Use commercial nonflammable solvents.

Fueling



Stop the engine and let it cool before adding fuel. No smoking! Do not refuel a machine near open flames or sparks. Fill the fuel tank outdoors.

Ultra Low Sulfur Diesel (ULSD) poses a greater static ignition hazard than earlier diesel formulations with higher Sulfur content. Avoid death or serious injury from fire or explosion. Consult with your fuel or fuel system supplier to ensure the delivery system is in compliance with fueling standards for proper grounding and bonding practices.

Starting

Do not use ether or starting fluids on any engine that has glow plugs or air intake heater. These starting aids can cause explosion and injure you or bystanders.

Use the procedure in the Operation & Maintenance Manual for connecting the battery and for jump starting.

Spark Arrester Exhaust System

The spark arrester exhaust system is designed to control the emission of hot particles from the engine and exhaust system, but the muffler and the exhaust gases are still hot.

Check the spark arrester exhaust system regularly to make sure it is maintained and working properly. Use the procedure in the Operation & Maintenance Manual for cleaning the spark arrester muffler (if equipped).

FIRE PREVENTION (CONT'D)

Welding And Grinding

Always clean the machine and attachment, disconnect the battery, and disconnect the wiring from the Bobcat controllers before welding. Cover rubber hoses, battery and all other flammable parts. Keep a fire extinguisher near the machine when welding.

Have good ventilation when grinding or welding painted parts. Wear dust mask when grinding painted parts. Toxic dust or gas can be produced.

Dust generated from repairing nonmetallic parts such as hoods, fenders or covers can be flammable or explosive. Repair such components in a well ventilated area away from open flames or sparks.

Fire Extinguishers

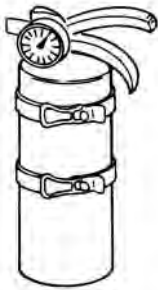

Know where fire extinguishers and first aid kits are located and how to use them. Inspect the fire extinguisher and service the fire extinguisher regularly. Obey the recommendations on the instructions plate.

SERIAL NUMBER LOCATIONS

Always use the serial number of the loader when requesting service information or when ordering parts. Early or later models (identification made by serial number) may use different parts, or there may be different procedures to follow when performing a specific service operation.

Loader Serial Number

Figure 1

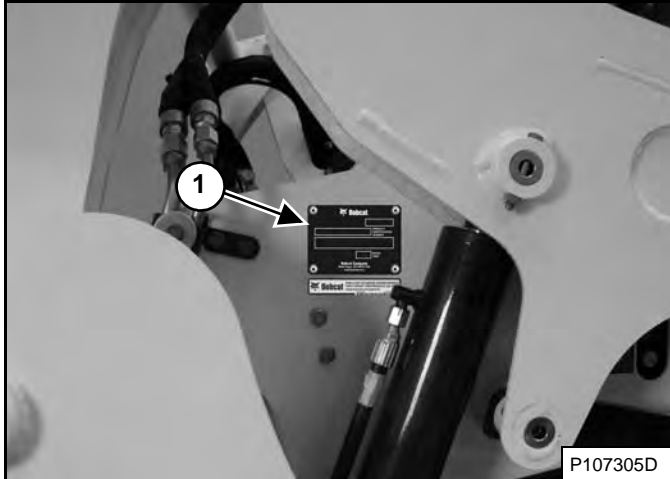

The loader serial number plate (Item 1) [Figure 1] is located on the outside of the loader frame.

Engine Serial Number

Figure 3

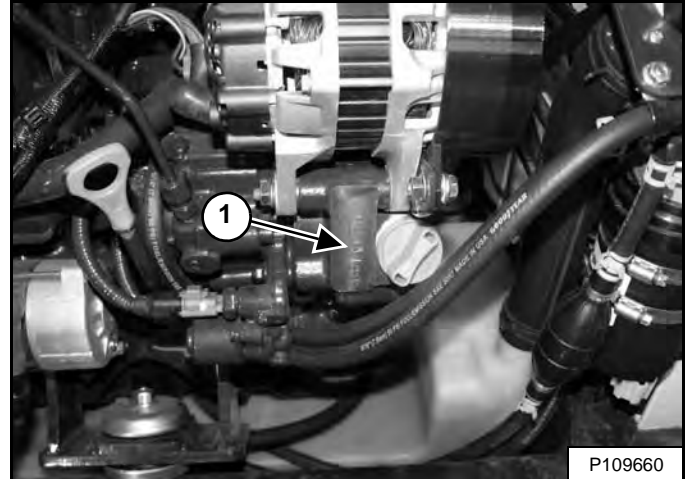

The engine serial number (Item 1) [Figure 3] is located on the side of the engine next to the oil fill cap.

Figure 2

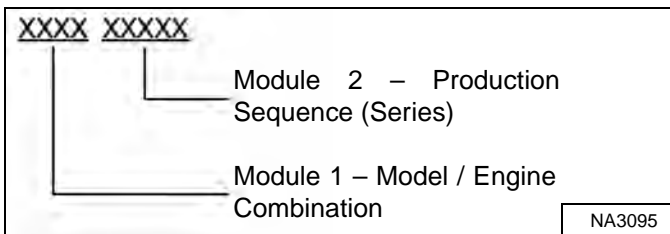

Explanation of loader Serial Number [Figure 2]:

1. The four digit Model / Engine Combination Module number identifies the model number and engine combination.
2. The five digit Production Sequence Number identifies the order in which the loader is produced.

DELIVERY REPORT

Figure 4

Bobcat Delivery Report Loader

Dealer Number: _____ Dealer Name: _____

Machine Name: _____

PERFORMANCE CHECK

Item	Inspection	Pass	Fail
1	Engine Oil Level		
2	Hydraulic Oil Level		
3	Transmission Oil Level		
4	Water Level		
5	Water Filter		
6	Water Pump		
7	Water Hose		
8	Water Valve		
9	Water Control		
10	Water Drain		
11	Water Seal		
12	Water Gasket		
13	Water Bolt		
14	Water Nut		
15	Water Washer		
16	Water Sealant		
17	Water Sealant		
18	Water Sealant		
19	Water Sealant		
20	Water Sealant		
21	Water Sealant		
22	Water Sealant		
23	Water Sealant		
24	Water Sealant		
25	Water Sealant		

WARNING

1. Read and understand the operator's manual before operating the loader. 2. Do not operate the loader until you have read and understood the operator's manual. 3. Do not operate the loader if you are under the influence of alcohol, drugs, or medication. 4. Do not operate the loader if you are tired or fatigued. 5. Do not operate the loader if you are not properly trained. 6. Do not operate the loader if you are not wearing your seat belt. 7. Do not operate the loader if you are not wearing your safety glasses. 8. Do not operate the loader if you are not wearing your hearing protection. 9. Do not operate the loader if you are not wearing your work clothes. 10. Do not operate the loader if you are not wearing your safety shoes. 11. Do not operate the loader if you are not wearing your fall protection. 12. Do not operate the loader if you are not wearing your PPE. 13. Do not operate the loader if you are not wearing your hard hat. 14. Do not operate the loader if you are not wearing your gloves. 15. Do not operate the loader if you are not wearing your earplugs. 16. Do not operate the loader if you are not wearing your earmuffs. 17. Do not operate the loader if you are not wearing your eye protection. 18. Do not operate the loader if you are not wearing your face shield. 19. Do not operate the loader if you are not wearing your respirator. 20. Do not operate the loader if you are not wearing your hood. 21. Do not operate the loader if you are not wearing your helmet. 22. Do not operate the loader if you are not wearing your harness. 23. Do not operate the loader if you are not wearing your lanyard. 24. Do not operate the loader if you are not wearing your lifeline. 25. Do not operate the loader if you are not wearing your anchor.

Dealer Representative Signature: _____ Date: _____

Owner/Operator Signature: _____ Date: _____

NA3106

The delivery report [Figure 4] contains a list of items that must be explained or shown to the owner or operator by the dealer when the Bobcat loader is delivered.

The delivery report must be reviewed and signed by the owner or operator and the dealer.

LOADER IDENTIFICATION

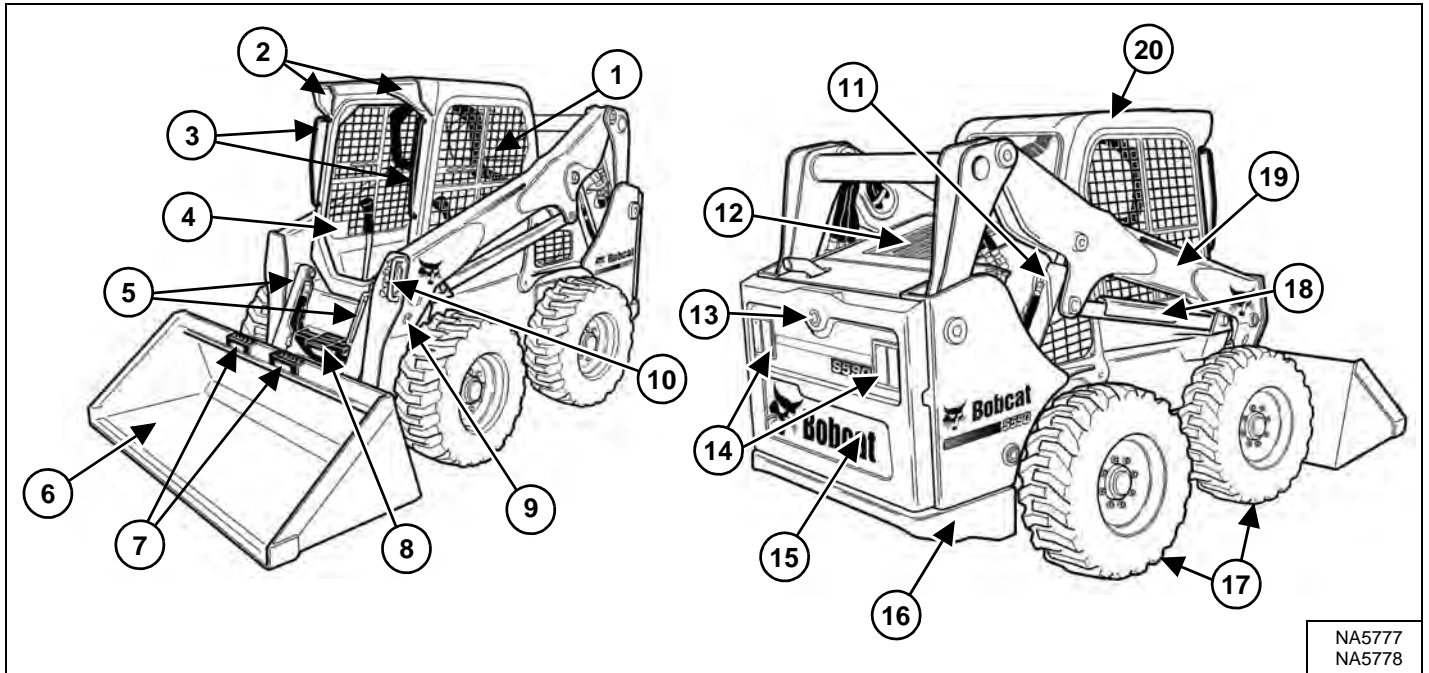

ITEM	DESCRIPTION	ITEM	DESCRIPTION
1	Operation & Maintenance Manual and Operator's Handbook	11	Lift Cylinder (Both Sides)
2	Front Lights	12	Rear Grille
3	Grab Handles	13	Back-up Alarm
4	Operator Seat with Seat Belt and Seat Bar	14	Rear Work Lights and Taillights
5	Tilt Cylinders	15	Rear Door
6	Bucket [A]	16	Rear Tie-down (Both Sides) Front Tie-down located behind Bucket
7	Bucket Steps	17	Tires [C]
8	Step	18	Lift Arm Support Device
9	Alternate Front Tie-down (Both Sides)	19	Lift Arm
10	Front Auxiliary Quick Couplers	20	Operator Cab (ROPS and FOPS) [B]

[A] Bucket – Several different buckets and other attachments are available for the Bobcat loader.

[B] ROPS – Roll-Over Protective Structure per ISO 3471 and FOPS – Falling-Object Protective Structure per ISO 3449, Level I. Level II is available.

[C] Tires – Standard tires are shown. Several different tire styles and sizes are available for the Bobcat loader.

SAFETY AND MAINTENANCE

LIFTING AND BLOCKING THE LOADER	10-10-1
Procedure	10-10-1
LIFT ARM SUPPORT DEVICE	10-20-1
Description	10-20-1
Installing	10-20-2
Removing	10-20-3
OPERATOR CAB	10-30-1
Description	10-30-1
Cab Door Sensor	10-30-1
Raising	10-30-2
Lowering	10-30-3
Special Applications Kit	10-30-4
Special Applications Kit Inspection And Maintenance	10-30-4
Forestry Door And Window Kit	10-30-5
Forestry Door And Window Kit Inspection And Maintenance	10-30-5
TRANSPORTING THE LOADER ON A TRAILER	10-40-1
Loading And Unloading	10-40-1
Fastening	10-40-1
TOWING THE LOADER	10-50-1
Procedure	10-50-1
REMOTE START TOOL KIT- MEL1563	10-60-1
Remote Start Tool - MEL1563	10-60-1
Service Tool Harness Communicator - MEL1566	10-60-3
Remote Start Procedure	10-60-3
REMOTE START TOOL (SERVICE TOOL) KIT - 7217666	10-61-1
Description	10-61-1
Remote Start Tool (Service Tool) - 7022042	10-61-2
Loader Service Tool Harness - 6689747	10-61-3
Computer Service Tool Harness - 6689746	10-61-4
Remote Start Procedure	10-61-5
SERVICE SCHEDULE	10-70-1
Maintenance Intervals	10-70-1
ENGINE AIR CLEANER	10-80-1
Replacing Filters	10-80-1
ENGINE COOLING SYSTEM	10-90-1
Maintenance Platform	10-90-1
Cleaning	10-90-1
Checking And Adding Coolant	10-90-4
Removing And Replacing Coolant	10-90-5

Thank you so much for reading.
Please click the “Buy Now!”
button below to download the
complete manual.



After you pay.

You can download the most
perfect and complete manual in
the world immediately.

Our support email:

ebooklibonline@outlook.com