



Bobcat®

Service Manual

Toolcat™ 5600 Utility Work Machine

S/N A0W111001 & Above



EQUIPPED WITH
TOOLCAT INTERLOCK
CONTROL SYSTEM (TICS™)



MAINTENANCE SAFETY



WARNING

Instructions are necessary before operating or servicing machine. Read and understand the Operation & Maintenance Manual, Operator's Handbook and signs (decals) on machine. Follow warnings and instructions in the manuals when making repairs, adjustments or servicing. Check for correct function after adjustments, repairs or service. Untrained operators and failure to follow instructions can cause injury or death. W-2003-0807



Safety Alert Symbol: This symbol with a warning statement, means: "Warning, be alert! Your safety is involved!" Carefully read the message that follows.

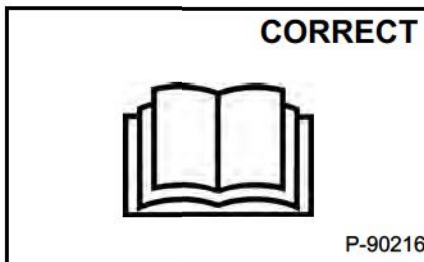

⚠ Never service the machine without instructions.

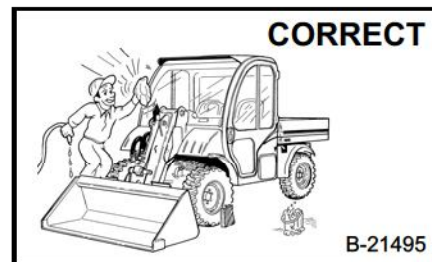

⚠ Cleaning and maintenance are required daily.

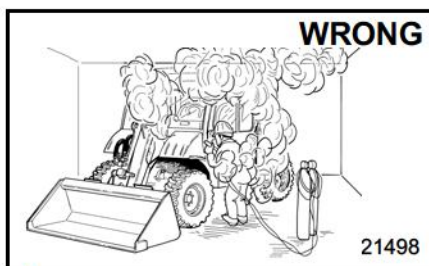

- ⚠ Have good ventilation when welding or grinding painted parts.
- ⚠ Wear dust mask when grinding painted parts. Toxic dust and gas can be produced.
- ⚠ Avoid exhaust fume leaks which can kill without warning. Exhaust system must be tightly sealed.

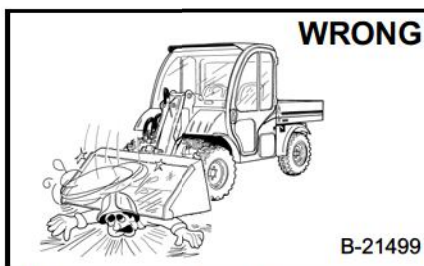

⚠ Disconnecting or loosening any hydraulic tubeline, hose, fitting, component or a part failure can cause lift arm or cargo box to drop. Do not go under lift arm or cargo box when raised unless supported by an approved lift arm or cargo box support device. Replace it if damaged.

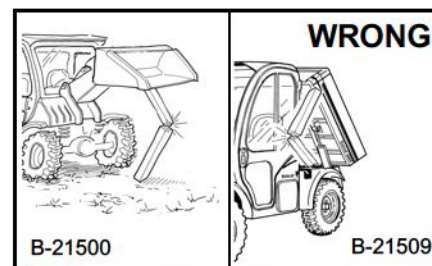

- ⚠ Never work on the machine with lift arm or cargo box up unless supported by an approved support device. Replace if damaged.
- ⚠ Never modify equipment or add attachments not approved by Bobcat Company.

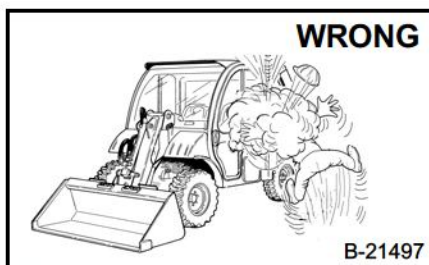

- ⚠ Stop, cool and clean engine of flammable materials before checking fluids.
- ⚠ Never service or adjust machine with the engine running unless instructed to do so in the manual.
- ⚠ Avoid contact with leaking hydraulic fluid or diesel fuel under pressure. It can penetrate the skin or eyes.
- ⚠ Never fill fuel tank with engine running, while smoking or when near open flame.

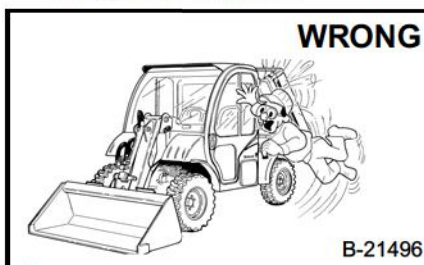

- ⚠ Keep body, jewelry and clothing away from moving parts, electrical contact, hot parts and exhaust.
- ⚠ Wear eye protection to guard from battery acid, compressed springs, fluids under pressure and flying debris when engines are running or tools are used. Use eye protection approved for type of welding.
- ⚠ Keep side access doors closed except for service.



- ⚠ Lead-acid batteries produce flammable and explosive gases.
- ⚠ Keep arcs, sparks, flames and lighted tobacco away from batteries.
- ⚠ Batteries contain acid which burns eyes or skin on contact. Wear protective clothing. If acid contacts body, flush well with water. For eye contact, flush well and get immediate medical attention.

Maintenance procedures which are given in the Operation & Maintenance Manual can be performed by the owner/operator without any specific technical training. Maintenance procedures which are not in the Operation & Maintenance Manual must be performed **ONLY BY QUALIFIED BOBCAT SERVICE PERSONNEL**. Always use genuine Bobcat replacement parts.

MSW25-0409

Dealer Copy -- Not for Resale

CONTENTS

SAFETY & MAINTENANCE	10-01
HYDRAULIC SYSTEM	20-01
HYDROSTATIC SYSTEM	30-01
DRIVE SYSTEM	40-01
MAINFRAME	50-01
ELECTRICAL SYSTEM & ANALYSIS	60-01
ENGINE SERVICE	70-01
HEATING, VENTILATION AND AIR CONDITIONING (HVAC)	80-01
SPECIFICATIONS	SPEC-01
ALPHABETICAL INDEX	INDEX-01

Dealer Copy -- Not for Resale















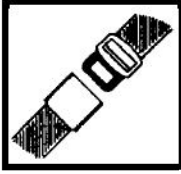

FOREWORD

FOREWORD	1-7
SAFETY INSTRUCTIONS	1-10
FIRE PREVENTION	1-12
Maintenance	1-12
Operation	1-12
Electrical	1-12
Hydraulic System	1-12
Fueling	1-12
Starting	1-12
Spark Arrester Exhaust System	1-12
Welding And Grinding	1-13
Fire Extinguishers	1-13
SERIAL NUMBER LOCATIONS	1-14
Utility Work Machine Serial Number	1-14
Engine Serial Number	1-14
DELIVERY REPORT	1-15
UTILITY WORK MACHINE IDENTIFICATION	1-16

FOREWORD

This manual is for the Toolcat Utility Work Machine mechanic. It provides necessary servicing and adjustment procedures for the Toolcat Utility Work Machine and its component parts and systems. Refer to the for operating instructions, starting procedure, daily checks, etc.

A general inspection of the following items must be made after the loader has had service or repair:

- | | | | |
|---|---|--|---|
| 1. Check that the ROPS/FOPS (Including front and rear window) is in good condition and is not modified. |  | 10. The parking brake must function correctly. |  |
| 2. Check that ROPS mounting hardware is tightened and is Bobcat approved. |  | 11. Enclosure door latches must open and close freely. |  |
| 3. The operator and passenger seat belts must be correctly installed, functional and in good condition. |  | 12. Bob-Tach wedges and linkages must function correctly and be in good condition. |  |
| 5. Check lift arm support device, replace if damaged. |  | 13. Safety treads and floor mats must be in good condition. |  |
| 6. Check cargo box support device, replace if damaged. |  | 14. Check for correct function of indicator lamps. |  |
| 7. Machine signs (decals) must be legible and in the correct location. |  | 15. Check hydraulic fluid level, engine oil level and fuel supply. |  |
| 8. Joystick control lever and foot pedals must return to neutral. |  | 16. Inspect for fuel, oil or hydraulic fluid leaks. |  |
| 9. Check for correct function of the work lights. |  | 17. Lubricate the machine. |  |

Dealer Copy -- Not for Resale

FW TC-0308 SM

18. Check the condition of the battery and cables.

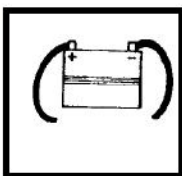

23. Check for any field modification not completed.



19. Inspect the air cleaner for damage or leaks. Check the condition of the element.



23. Operate the machine and check all functions.



20. Check the electrical charging system.

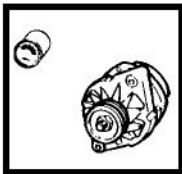

25. Check for correct function of the Toolcat Interlock Control System (TICS) before the machine is returned to the customer.

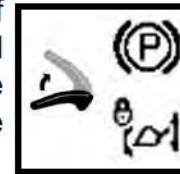

21. Check tires for wear and pressure. Use only approved tires.

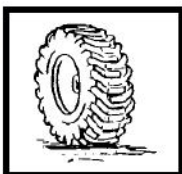

26. Check function or condition of all equipped options and accessories (examples: back-up alarm, fire extinguisher, rotating beacon, etc.).



22. Inspect for loose or broken parts or connections.



27. Recommend to the owner that all necessary corrections be made before the machine is returned to service.

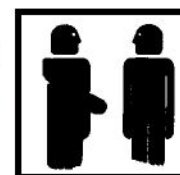

**CALIFORNIA
PROPOSITION 65 WARNING**

Diesel engine exhaust and some of its constituents are known to the state of California to cause cancer, birth defects and other reproductive harm.

FIRE PREVENTION



Maintenance

The machine and some attachments have components that are at high temperatures under normal operating conditions. The primary source of high temperatures is the engine and exhaust system. The electrical system, if damaged or incorrectly maintained, can be a source of arcs or sparks.

Flammable debris (leaves, straw, etc.) must be removed regularly. If flammable debris is allowed to accumulate, it can cause a fire hazard. Clean often to avoid this accumulation. Flammable debris in the engine compartment is a potential fire hazard.

The operator's area, engine compartment and engine cooling system must be inspected every day and cleaned if necessary to prevent fire hazards and overheating.

All fuels, most lubricants and some coolants mixtures are flammable. Flammable fluids that are leaking or spilled onto hot surfaces or onto electrical components can cause a fire.

Operation

Do not use the machine where exhaust, arcs, sparks or hot components can contact flammable material, explosive dust or gases.

Electrical



Check all electrical wiring and connections for damage. Keep the battery terminals clean and tight. Repair or replace any damaged part or wires that are loose or frayed.

Battery gas can explode and cause serious injury. Use the procedure in the Operation & Maintenance Manual for connecting the battery and for jump starting. Do not jump start or charge a frozen or damaged battery. Keep any open flames or sparks away from batteries. Do not smoke in battery charging area.

Hydraulic System

Check hydraulic tubes, hoses and fittings for damage and leakage. Never use open flame or bare skin to check for leaks. Hydraulic tubes and hoses must be properly routed and have adequate support and secure clamps. Tighten or replace any parts that show leakage.

Always clean fluid spills. Do not use gasoline or diesel fuel for cleaning parts. Use commercial nonflammable solvents.

Fueling



Stop the engine and let it cool before adding fuel. No smoking! Do not refuel a machine near open flames or sparks. Fill the fuel tank outdoors.

Starting

Do not use ether or starting fluids on any engine that has glow plugs. These starting aids can cause explosion and injure you or bystanders.

Use the procedure in the Operation & Maintenance Manual for connecting the battery and for jump starting.

Spark Arrester Exhaust System

The spark arrester exhaust system is designed to control the emission of hot particles from the engine and exhaust system, but the muffler and the exhaust gases are still hot.

Check the spark arrester exhaust system regularly to make sure it is maintained and working properly. Use the procedure in the Operation & Maintenance Manual for cleaning the spark arrester muffler (if equipped).

FIRE PREVENTION (CONT'D)

Welding And Grinding

Always clean the machine and attachment, disconnect the battery, and disconnect the wiring from the Bobcat controllers before welding. Cover rubber hoses, battery and all other flammable parts. Keep a fire extinguisher near the machine when welding.

Have good ventilation when grinding or welding painted parts. Wear dust mask when grinding painted parts. Toxic dust or gas can be produced.

Dust generated from repairing nonmetallic parts such as hoods, fenders or covers can be flammable or explosive. Repair such components in a well ventilated area away from open flames or sparks.

Fire Extinguishers

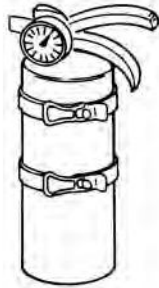

Know where fire extinguishers and first aid kits are located and how to use them. Inspect the fire extinguisher and service the fire extinguisher regularly. Obey the recommendations on the instructions plate.

SERIAL NUMBER LOCATIONS

Always use the serial number of the machine when requesting service information or when ordering parts. Early or later models (identification made by serial number) may use different parts, or it may be necessary to use a different procedure in doing a specific service operation.

Figure 1

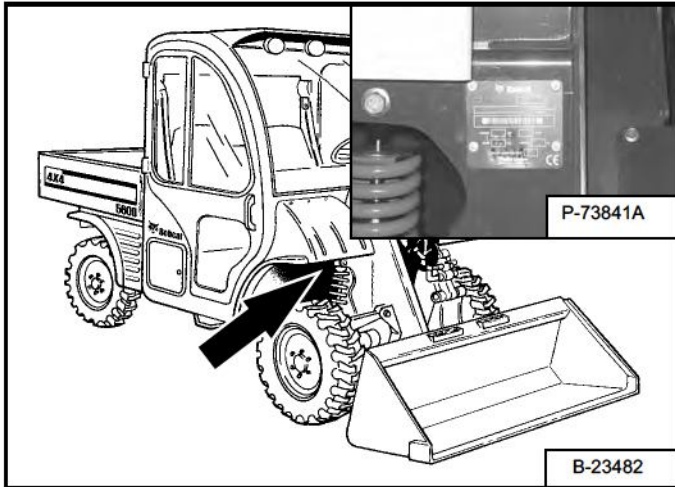

Utility Work Machine Serial Number

The Toolcat Utility Work Machine serial number plate is located on the rear of the frame below the front right fender [Figure 1].

Explanation of machine Serial Number:

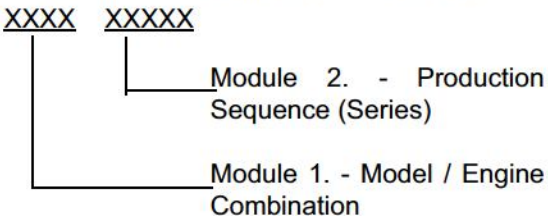

1. The four digit Model / Engine Combination Module number identifies the model number and engine combination.

2. The five digit Production Sequence Number identifies the order which the machine is produced.

Engine Serial Number

Figure 2

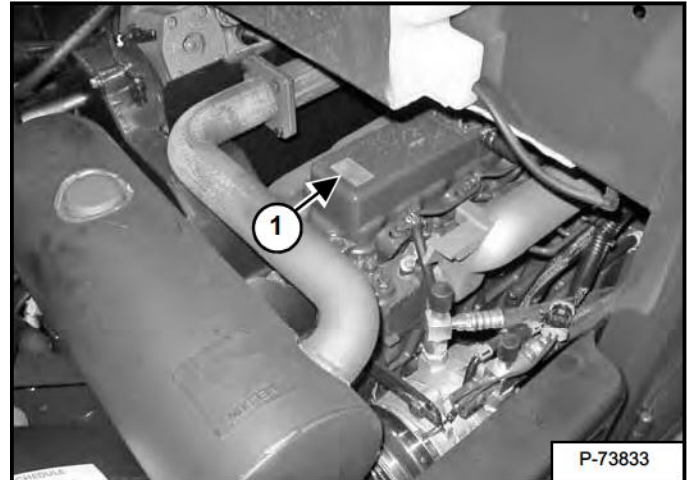

The engine serial number is located at the right end of the valve cover (Item 1) [Figure 2].

DELIVERY REPORT

Figure 3

The diagram shows a form titled "DELIVERY REPORT" with a "WARNING" section and a reference code "B-16315".

The delivery report [Figure 3] must be completed by the dealer and signed by the owner or operator when the Bobcat loader is delivered. An explanation of the form must be given to the owner.

UTILITY WORK MACHINE IDENTIFICATION

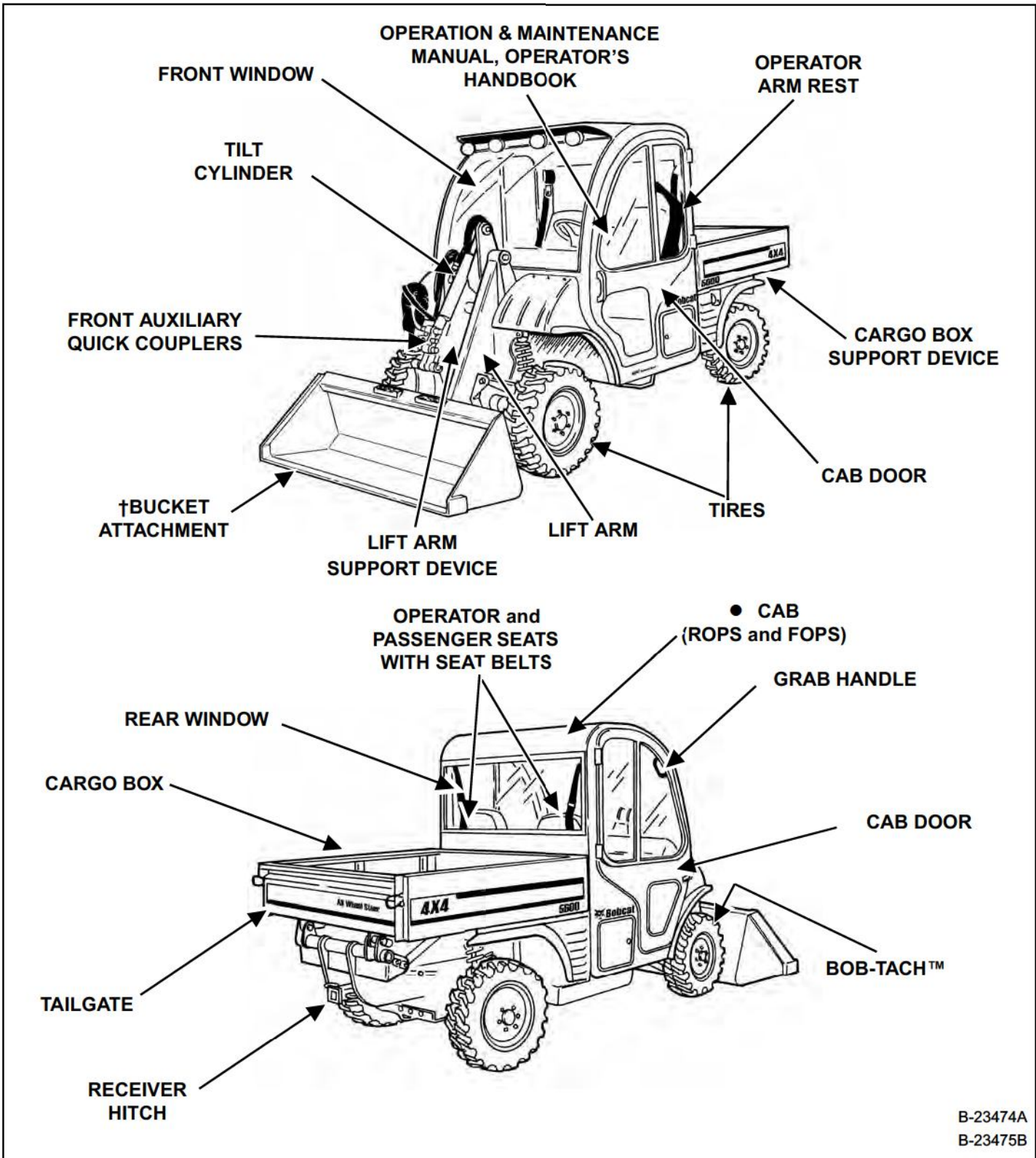

† BUCKET - Buckets and other attachments are available for the Toolcat™ utility work machine.

● ROPS and FOPS - Roll Over Protective Structure, per ISO 3471, and Falling Object Protective Structure per ISO 3449, Level I.

Dealer Copy -- Not for Resale

SAFETY & MAINTENANCE

LIFTING AND BLOCKING THE UTILITY WORK MACHINE	10-10-1
Procedure For Jackstand Placement On The Control Arms	10-10-1
Procedure For Jackstand Placement On The Frame	10-10-2
LIFT ARM SUPPORT DEVICE	10-20-1
Installing	10-20-1
Removing	10-20-1
CARGO BOX SUPPORT DEVICE	10-21-1
Installing	10-21-1
Removing	10-21-1
Raising The Cargo Box When Engine Is Not Running	10-21-2
OPERATOR CAB	10-30-1
Description	10-30-1
TRANSPORTING THE UTILITY WORK MACHINE ON A TRAILER	10-40-1
Loading And Unloading	10-40-1
Fastening	10-40-1
TOWING THE UTILITY WORK MACHINE	10-50-1
Procedure	10-50-1
REMOTE START TOOL KIT - MEL1563	10-60-1
Remote Start Tool - MEL1563	10-60-1
Service Tool Harness Control - MEL1565	10-60-2
Service Tool Harness Communicator - MEL1566	10-60-3
Remote Start Procedure	10-60-4
REMOTE START TOOL (SERVICE TOOL) KIT - 6689779	10-61-1
Description	10-61-1
Remote Start Tool (Service Tool) - 6689778	10-61-2
Service Tool Harness - 6689747	10-61-3
Computer Service Tool Harness - 6689746	10-61-4
Remote Start Procedure	10-61-5
SERVICE SCHEDULE	10-70-1
Chart	10-70-1
AIR CLEANER SERVICE	10-80-1
Replacing Filter Elements	10-80-1
ENGINE COOLING SYSTEM	10-90-1
Checking Level	10-90-1
Cleaning	10-90-2
Removing And Replacing Coolant	10-90-2

Dealer Copy -- Not for Resale

FUEL SYSTEM	10-100-1
Fuel Specifications	10-100-1
Biodiesel Blend Fuel	10-100-1
Filling The Fuel Tank	10-100-2
Fuel Filter	10-100-2
Removing Air From The Fuel System	10-100-3
Filling A Portable Fuel Container	10-100-3
ENGINE LUBRICATION SYSTEM	10-110-1
Checking And Adding Engine Oil	10-110-1
Engine Oil Chart	10-110-1
Removing And Replacing Oil And Filter	10-110-2
HYDRAULIC / HYDROSTATIC SYSTEM	10-120-1
Checking Fluid	10-120-1
Hydraulic / Hydrostatic Fluid Chart	10-120-1
Adding Fluid	10-120-1
Alternate Fill Procedure	10-120-2
Removing And Replacing Hydraulic / Hydrostatic And Case Drain Filters	10-120-3
Removing And Replacing Hydraulic Fluid	10-120-4
Breather Cap	10-120-6
TRANS AXLE (FRONT AND REAR)	10-130-1
Checking And Adding Lubricant	10-130-1
Removing And Replacing Lubricant	10-130-2
BOB-TACH (HAND LEVER)	10-140-1
Inspection And Maintenance	10-140-1
BOB-TACH (POWER)	10-141-1
Inspection And Maintenance	10-141-1
LUBRICATING THE UTILITY WORK MACHINE	10-150-1
Lubrication Locations	10-150-1
TIRE MAINTENANCE	10-160-1
Wheel Nuts	10-160-1
Rotating	10-160-1
Mounting	10-160-1
SPARK ARRESTER MUFFLER	10-170-1
Cleaning Procedure	10-170-1
PIVOT PINS	10-180-1
Inspection And Maintenance	10-180-1
UTILITY WORK MACHINE STORAGE AND RETURN TO SERVICE	10-190-1
Storage	10-190-1
Return To Service	10-190-1

STOPPING THE ENGINE AND LEAVING THE UTILITY WORK MACHINE	10-200-1
Procedure	10-200-1
Emergency Exit (When Equipped With Cab)	10-200-1
SEAT BELT	10-210-1
Inspection And Maintenance	10-210-1

Dealer Copy -- Not for Resale

Thank you so much for reading.
Please click the “Buy Now!”
button below to download the
complete manual.



After you pay.

You can download the most
perfect and complete manual in
the world immediately.

Our support email:

ebooklibonline@outlook.com