

218 DRAPER PLATFORM



JOHN DEERE

OPERATORS MANUAL 218 DRAPER PLATFORM

OMH120055 K4 English

JOHN DEERE HARVESTER WORKS
OMH120055 K4

LITHO IN THE U.S.A. (REVISED)
ENGLISH



INTRODUCTION



This safety alert symbol identifies important safety messages in this manual. When you see this symbol, be alert to the possibility of personal injury and carefully read the message that follows.

Your operator's manual contains SI metric equivalents which follow immediately after the U.S. customary units of measure.

"Right-hand" and "left-hand" sides are determined by facing in the direction the platform will travel when in use.

Record your platform serial number in the space provided in Specifications.

The warranty on this platform appears on your copy of the purchase order which you should have received from your dealer when making your purchase. This warranty provides you the assurance that John Deere will back its products where defects appear within the warranty period. In some circumstances, John Deere also provided field improvements, often without charge to the customer, even if the product is out of warranty.

Warranty and field improvements are a part of John Deere's product support program for customers who operate and maintain their equipment as described in this manual. Should the equipment be abused or modified to change its performance beyond the original factory specifications, the warranty will become void and field improvements may be denied.

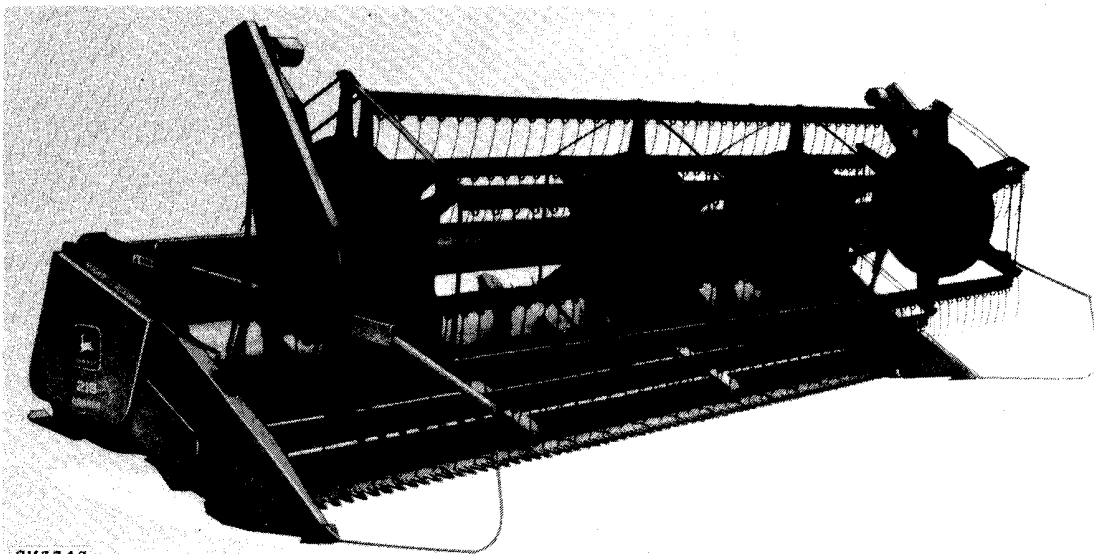

SM3743



Contents

	Page
Introduction.....	Inside
Contents.....	1
Safety.....	2
Attaching and Detaching.....	4
Transporting.....	6
Operating the Platform.....	7
Lubricants.....	19, 20
Lubrication and Maintenance.....	21, 22
Trouble Shooting.....	23-26
Service.....	27-34
Storage.....	35
Crime Prevention.....	35B
Assembly.....	36-44
Specifications.....	45
Index.....	46



Safety

SAFETY DECALS



H28488N

 **CAUTION, WARNING or DANGER:** Decals with these headings and symbol indicate the possibility of personal injury.

IMPORTANT: Decals with this heading indicate the possibility of damage to the machine.

Decals are located in areas where they apply.

AVOID CONTACT WITH MOVING PARTS

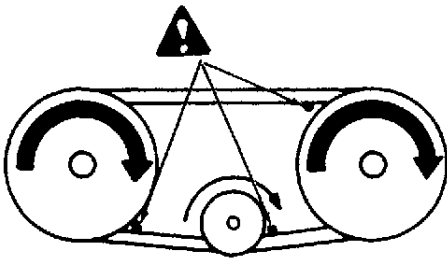

H26880

Keep hands, feet, and clothing away from power-driven parts.

Never clean, lubricate, or adjust the platform when it is running.

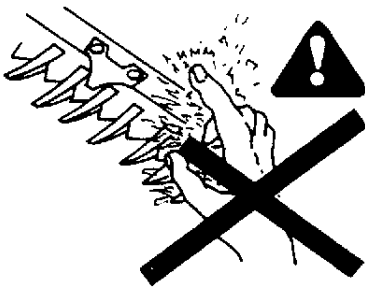

H36895

Never attempt to clear obstructions off the header unless the combine engine is shut off.

Everyone must be clear before starting engine or running combine.

OPERATE SAFELY

Clothing worn by operator must be fairly tight and belted. Loose jackets, shirts, or sleeves must never be worn.

Anytime work is being done under reel or platform, the hydraulic cylinder safety stops must be placed in the safety position.

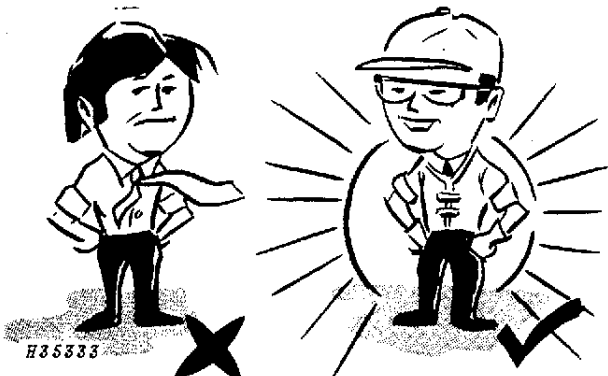

H35333

H35333

AVOID HIGH PRESSURE LEAKS

Escaping fluid under pressure can penetrate the skin causing serious injury. Relieve pressure before disconnecting hydraulic or other lines. Tighten all connections before applying pressure. Keep hands and body away from pinholes and nozzles which eject fluids under high pressure. Use a piece of cardboard or paper to search for leaks. Do not use your hand.

If ANY fluid is injected into the skin, it must be surgically removed within a few hours by a doctor familiar with this type injury or gangrene may result.

Cracking hydraulic line fittings to lower the feeder house will result in an instantaneous dropping of feeder house or feeder house and header.

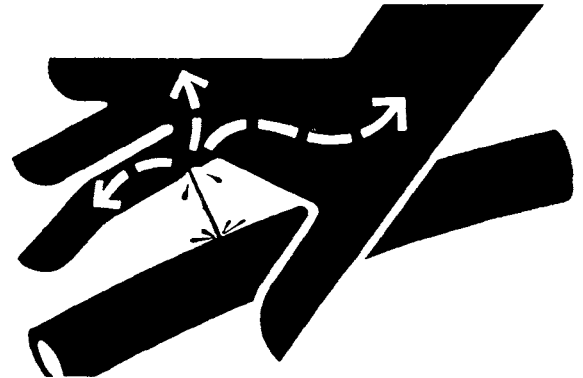

X9811

PROTECT AGAINST NOISE

Prolonged exposure to loud noise can cause impairment or loss of hearing.

Wear a suitable hearing protective device as earmuffs (A) or earplugs (B) to protect against objectionable or uncomfortable loud noises.

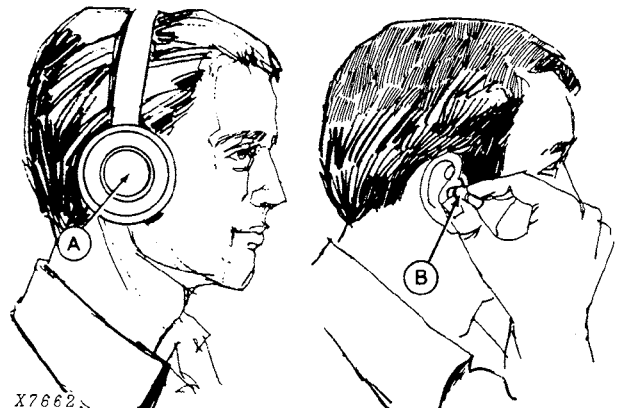

A - Earmuffs
B - Earplugs

X7862

LEAVING COMBINE UNATTENDED

Before leaving the combine unattended, turn off engine and remove keys. Support the platform with the hydraulic cylinder safety stop or lower it to the ground. Place the gearshift lever in neutral and engage the parking brake. Lock cab doors on 7720 and 8820 Combines.

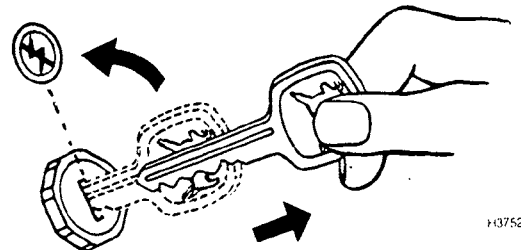

H37524

TRANSPORT SAFELY

When transporting the combine on a road or highway, use accessory lights and devices for adequate warning to the operators of other vehicles. In this regard, check local governmental regulations. Always check width laws.



Attaching and Detaching

ATTACHING

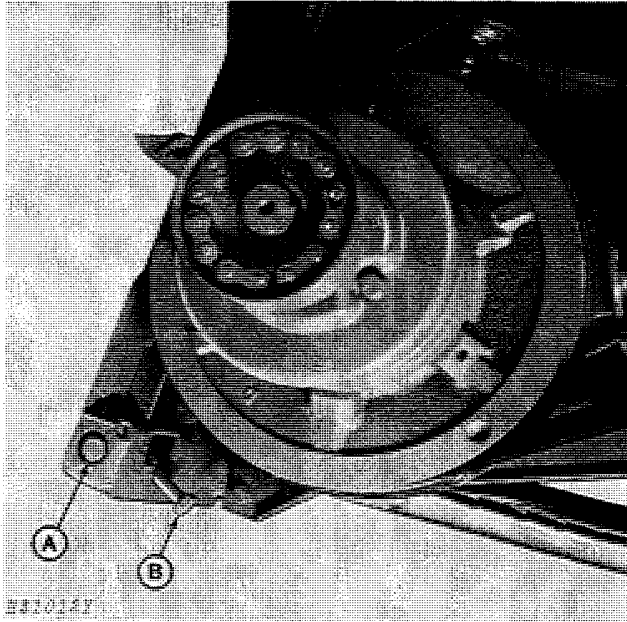

Illustrated on 7720 Combine

IMPORTANT: (7720 and 8820 Combines) Lock pin (A) (both sides) must be positioned in before attaching header. Position pin by sliding stop bolt (B) in and then pivoting it down. If pins are left in the out position, damage to the feeder house will result when mounting a platform.

A - Lock Pin
B - Stop Bolt

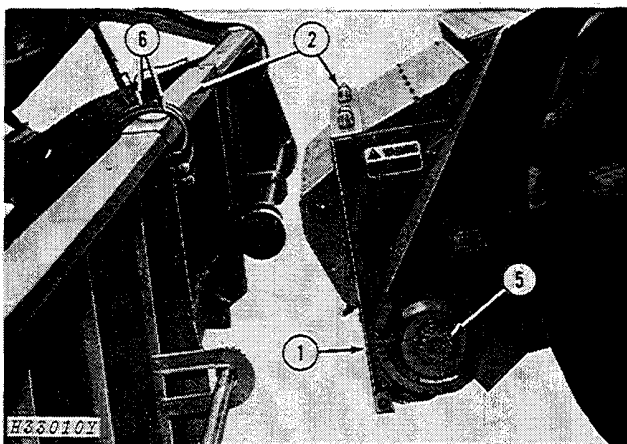

Combines (-600000)

1. Start engine and lower feeder house.
2. Drive combine slowly forward until feeder house is centered in platform opening. Raise feeder house, lifting platform, all the way up. Shut off engine.

3. Disconnect chain (A) and lower hydraulic cylinder safety stop (B) on lift cylinder.

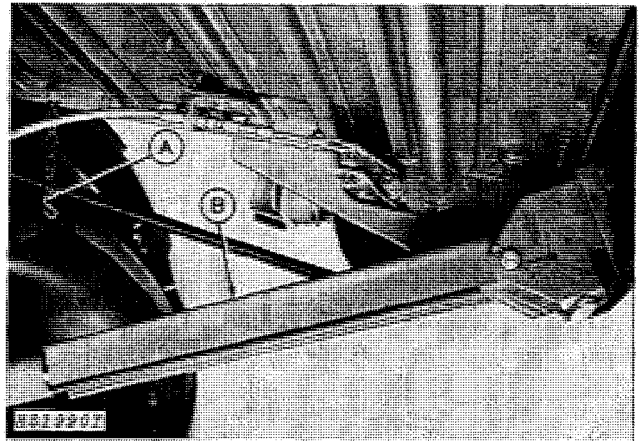

A - Support Chain
B - Safety Stop

4. (7720 and 8820 Combines) Slide and pivot stop bolt (A) up, and out to lock pin into header. Repeat procedure for other side.

NOTE: Loosen mating lock plate (B) on platform to let lock pin lock and center into platform. Torque nut on lock plate (B) to 170 ft-lbs. (231 N•m) Repeat procedure for other side.

NOTE: On 8820 Combines with variable speed feeder house, install coupler shipped with feeder house on left-hand platform drive shaft.

(7700 Combines) Secure platform to feeder house with three 5/8 x 1-1/2-inch round head bolts, 21/32 x 2 x .250-inch flat washers, lock washers and nuts.

5. Place chain around sprockets and slide coupler over sprockets and chain. Repeat for other side.
6. Connect reel lift and reel drive hoses under operator's platform or on feeder house.

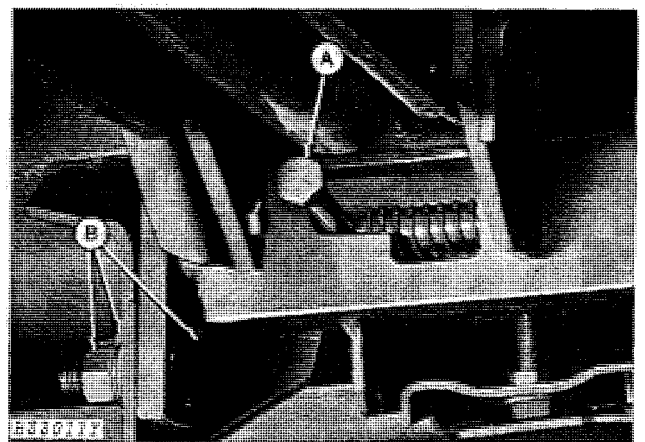

Illustrated on 7720 Combine

A - Stop Bolt
B - Lock Plate

DETACHING

1. Raise platform and lower hydraulic cylinder safety stops. Shut off engine.
2. Disconnect reel lift and reel drive hoses under operator's platform or on feeder house.

IMPORTANT: To prevent damage to hydraulic system connect reel drive hoses together under operator's platform or on feeder house. These hoses stay with combine.

3. Slide coupler away from sprocket and remove chain. Repeat for other side.
4. (7720 and 8820 Combines) Disengage lock pin by pulling stop bolt out pivoting it down. Repeat for other side. (7700 Combine) remove three 5/8 x 1-1/2-inch round head bolts, 21/32 x 2 x .250-inch flat washers, lock washers and nuts.
5. Raise hydraulic cylinder safety stops and hook with chain. Lower platform to the ground and drive combine slowly backward until feeder house is free from platform.



Transporting

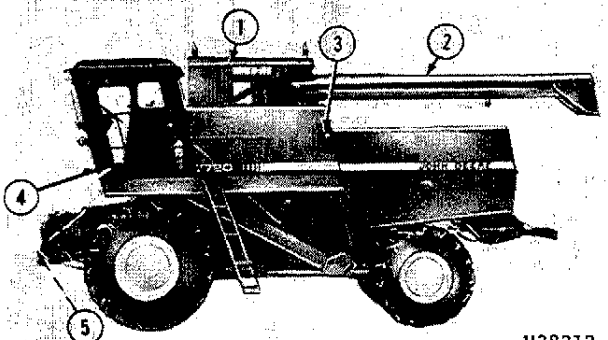

H38212

H38212

Check local width laws before transporting.

The platform can be transported by leaving it attached to the combine.

1. Empty grain tank.
2. Swing unloading auger back and secure with transport brace.
3. Turn on combine flashing warning light, unless prohibited by local law.
4. Couple combine brake pedals together.
5. Lower reel completely and raise platform to a position that will keep it off the ground but still allow good visibility.



Operating the Platform

GENERAL INFORMATION

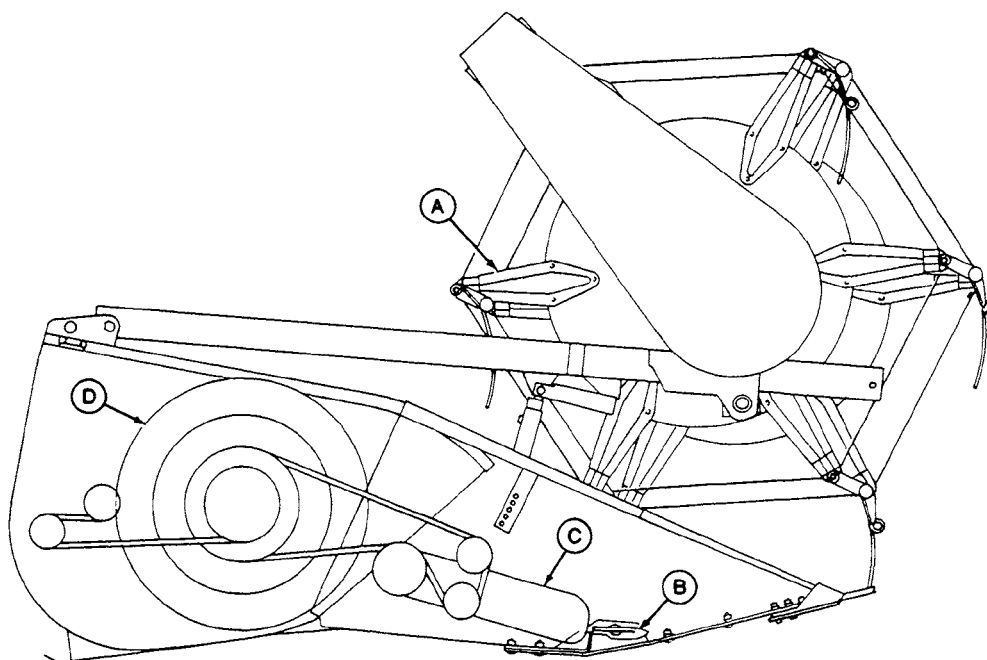

A - Pickup Reel

B - Cutterbar

C - Draper

D - Auger

H37401

The draper platform receives the rice and moves it to the front of the feeder house with a pickup reel, cutterbar, draper and auger. Retracting fingers in the auger feed the material to the feeder conveyor.

Tall or downed and twisted rice is cut by the cutterbar and conveyed evenly by the drapers. This eliminates bunching and uneven feeding of the rice to the auger, feeder conveyor and threshing cylinder.

Thank you so much for reading.
Please click the “Buy Now!”
button below to download the
complete manual.



After you pay.

You can download the most
perfect and complete manual in
the world immediately.

Our support email:

ebooklibonline@outlook.com