

JOHN DEERE
WORLDWIDE CONSTRUCTION
AND FORESTRY DIVISION

Skid Steer
280

OMKV18651 B3

OPERATOR'S MANUAL



JOHN DEERE

⚠ WARNING: Diesel engine exhaust and some of its constituents are known to the State of California to cause cancer, birth defects, and other reproductive harm.

California Proposition 65 Warning

North American Version
Litho in U.S.A.

INTRODUCTION

Thank You for Purchasing a John Deere Product

We appreciate having you as a customer and wish you many years of safe and satisfied use of your machine.

Using Your Operator's Manual

This manual is an important part of your machine and should remain with the machine at all times.

Reading your operator's manual will help you and others avoid personal injury or damage to the machine.

Information given in this manual will provide the operator with the safest and most effective use of the machine. Knowing how to operate this machine safely and correctly will allow you to train others who may operate this machine.

This manual and safety signs on your machine may also be available in other languages (see your Authorized John Deere Skid Steer Dealer to order).

Sections in your operator's manual are placed in a specific order to help you understand all the safety messages and learn the controls so you can operate this machine safely. You can also use this manual to answer any specific operating or servicing questions. A convenient index located at the end of this book will help you to find needed information quickly.

The machine shown in this manual may differ slightly from your machine, but will be similar enough to help you understand our instructions.

RIGHT and LEFT sides are determined by facing in the direction the machine will travel when going forward. When you see a broken line arrow (----->), the item referred to is hidden from view.

Before delivering this machine, your dealer performed a predelivery inspection to ensure best performance.

Special Messages

Your manual contains special messages to bring attention to potential safety concerns, machine damage as well as helpful operating and servicing information. Please read all the information carefully to avoid injury and machine damage.



CAUTION: Avoid injury! This symbol and text highlight potential hazards or death to the operator or bystanders that may occur if the hazards or procedures are ignored.

IMPORTANT: Avoid damage! This text is used to tell the operator of actions or conditions that might result in damage to the machine.

NOTE: Information is given throughout the manual that may help the operator with the operation or service of the machine.

PRODUCT IDENTIFICATION

Record Identification Numbers

Skid Steers

280 PIN (380001 -)

If you need to contact an Authorized Service Center for information on servicing, always provide the product model and identification numbers.

You will need to locate the identification numbers for the product. Record the information in the spaces provided below.

DATE OF PURCHASE:

DEALER NAME:

DEALER PHONE:

PRODUCT IDENTIFICATION NUMBER (A):

ENGINE SERIAL NUMBER (B):

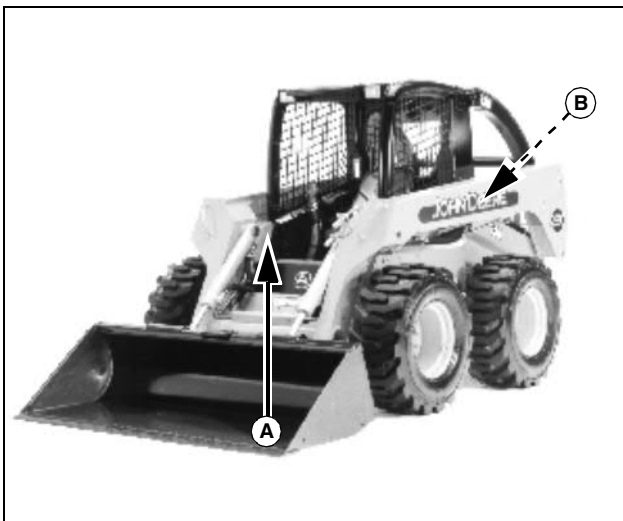

KV1172

TABLE OF CONTENTS

Safety	1
Operating	11
Replacement Parts.....	35
Service Intervals.....	36
Service Lubrication.....	37
Service Engine	38
Service Chain Case.....	46
Service Hydraulics.....	47
Service Steering & Brakes.....	50
Service Electrical.....	52
Service Miscellaneous.....	57
Troubleshooting	63
Storage	68
Specifications	69
Warranty	75
Index.....	79

All information, illustrations and specifications in this manual are based on the latest information at the time of publication. The right is reserved to make changes at any time without notice.

COPYRIGHT© 2003
DEERE & COMPANY
Moline, Illinois
All rights reserved
Previous Editions
COPYRIGHT©

OMKV18651 B3 - English

SAFETY

Understanding The Machine Safety Labels

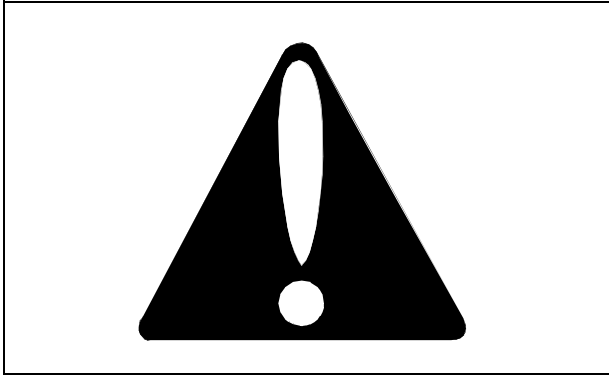

MIF

The machine safety labels shown in this section are placed in important areas on your machine to draw attention to potential safety hazards.

On your machine safety labels, the words DANGER, WARNING, and CAUTION are used with this safety-alert symbol. DANGER identifies the most serious hazards.

The operator's manual also explains any potential safety hazards whenever necessary in special safety messages that are identified with the word, CAUTION, and the safety-alert symbol.

CAUTION - Avoid Overturn

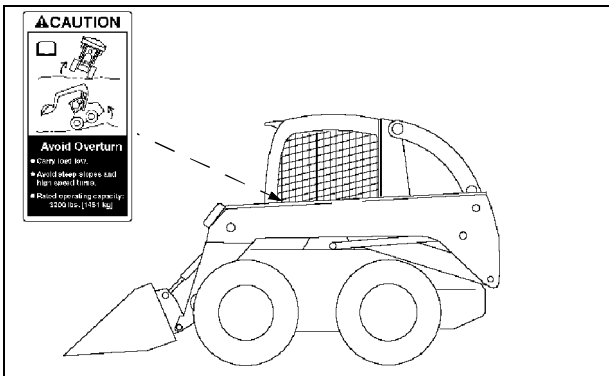

KV14256 T165349

- Carry Load Low
- Avoid Steep Slopes and High Speed Turns
- Rated Operating Capacity

DANGER - Avoid Death or Serious Injury

Before Removing Seat Belt and Leaving Seat:

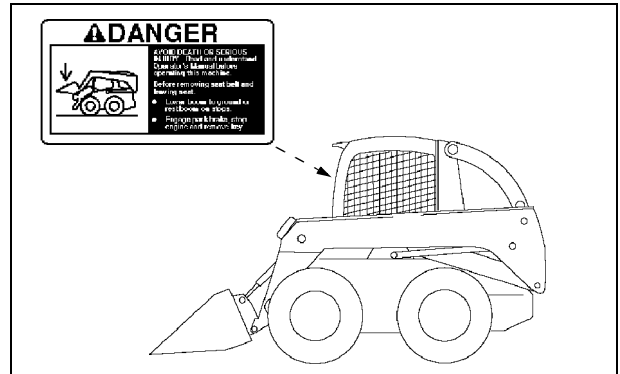

KV14256 T165350

- Lower Boom To Ground or Rest Boom on Stops
- Engage Park Brake, Stop Engine and Remove Key

CAUTION - Avoid Injury

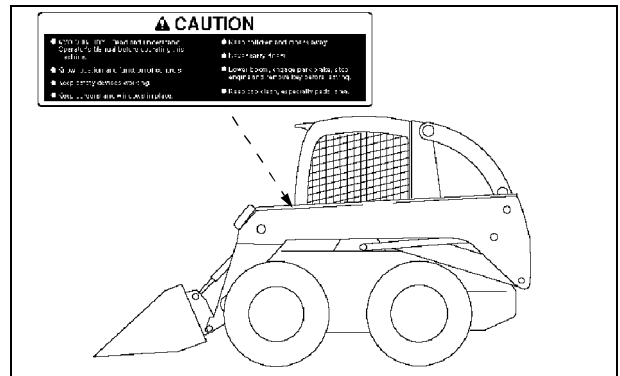

KV14256 T165351

- Read and Understand Operator's Manual Before Operating this Machine
- Know Location and Function of Controls
- Keep Safety Devices Working
- Keep Screens and Windows in Place
- Keep Children and Others Away
- Never Carry Riders
- Lower Boom, Engage Park Brake, Stop Engine and Remove Key Before Leaving
- Keep Cab Clean, Especially Pedal Area

SAFETY

WARNING - Avoid Injury

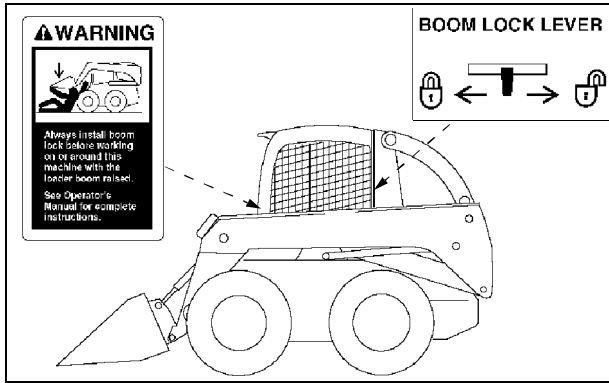

Always install boom lock before working on or around this machine with the loader boom raised.

See Operator's Manual for complete instructions.

WARNING - Avoid Injury

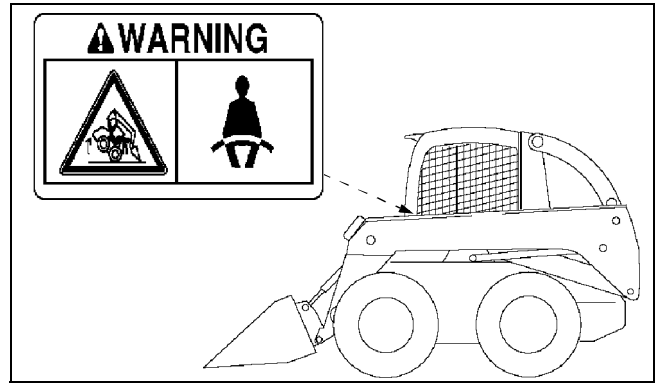

Always wear seat belt when operating skid steer.

Failure to wear seat belt could result in an injury from an accident such as an overturn.

WARNING - Emergency Cab Exit

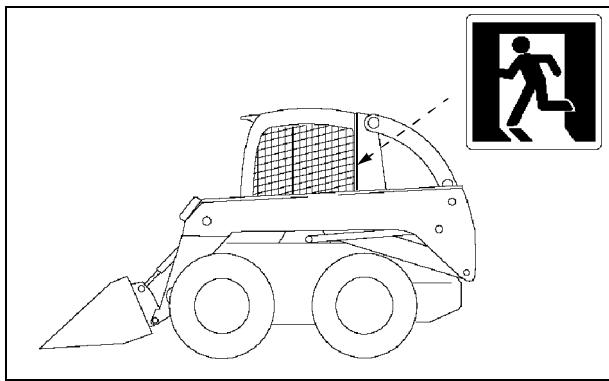

Remove the rear window to provide an exit in an emergency when the front exit is blocked.

CAUTION - Avoid Injury

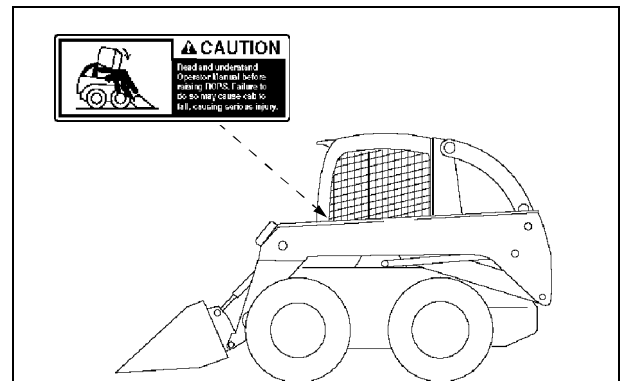

Read and Understand Operator Manual Before Raising ROPS. Failure to do so May Cause Cab to Fall Causing Serious Injury.

SAFETY

WARNING - Pinch Area

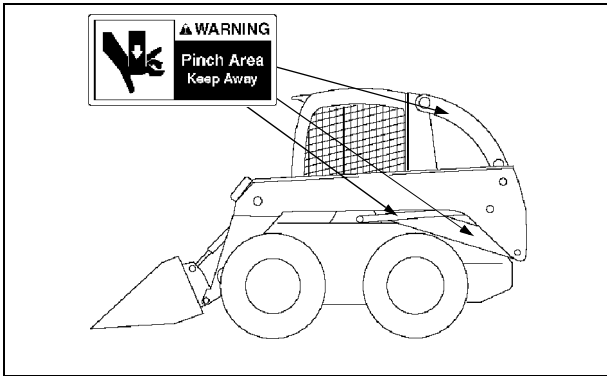

KV14256 T165344

Keep Away

IMPORTANT

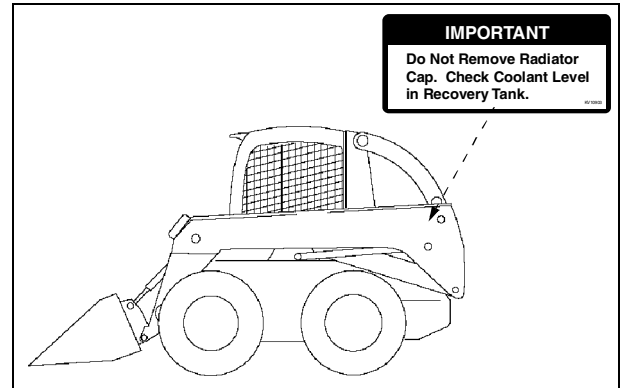

KV14256 KV10903

Do Not Remove Radiator Cap. Check Coolant Level in Recovery Tank.

WARNING - DANGER

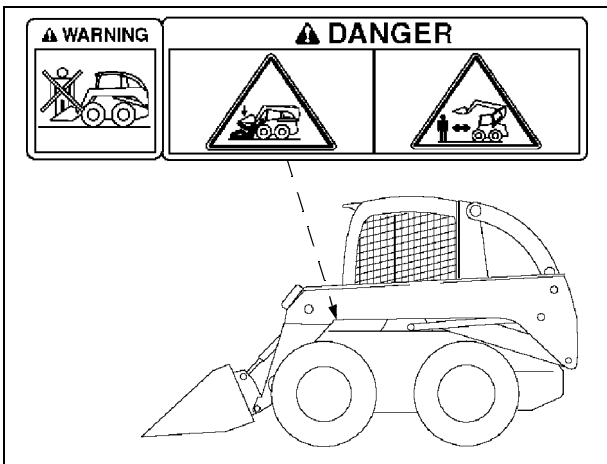

KV14256 T165356

- DO NOT allow riders in the bucket.
- Never stand or lean anywhere on skid steer or linkage will crush you.

WARNING

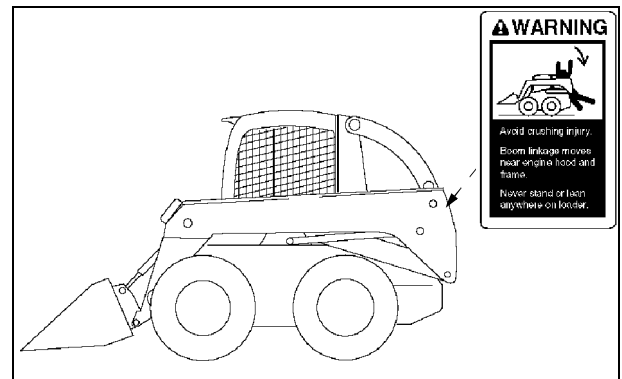

KV14256 T165347

- Boom Moves Near Engine Hood and Frame.
- Never Stand Or Lean Anywhere On Skid Steer Or Linkage Will Crush You.

SAFETY

CAUTION - Avoid an Explosion

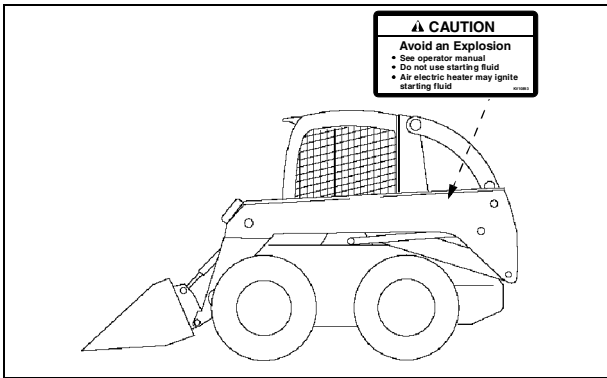

KV14256 KV10893

- See operator manual
- Do not use starting fluid
- Air electric heater may ignite starting fluid

WARNING - Avoid Rotating Fan

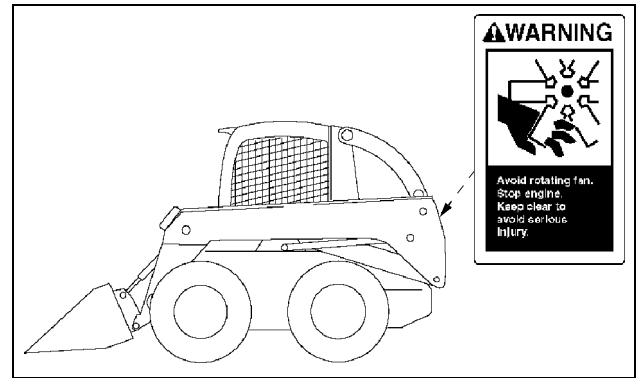

KV12456 T165346

Stop engine. Keep clear to avoid serious injury.

CAUTION - To Prevent Shock

WARNING

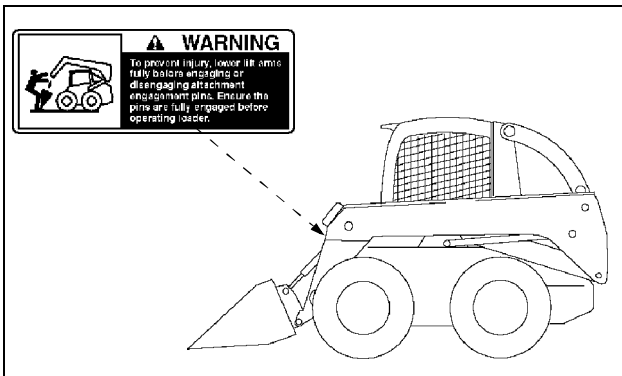

KV12456 T165357

To prevent injury, lower lift arms fully before engaging or disengaging attachment engagement pins. Ensure the pins are fully engaged before operating loader.

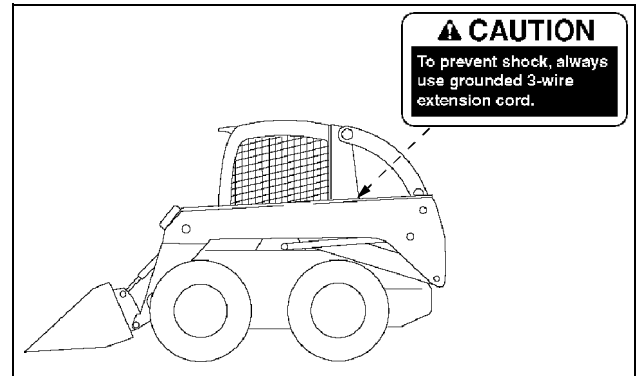

KV12456 T165345

Always use grounded 3-wire extension cord.

SAFETY

ROPS Certification Label

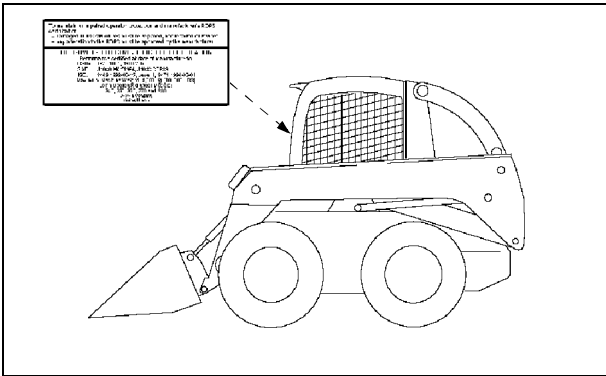

KV14256 T165362

To maintain unimpaired operator protection and manufacturer's ROPS certification:

- Damaged ROPS structures must be replaced, not repaired or revised.
- Any alteration to the ROPS must be approved by the manufacturer.

ROLL-OVER PROTECTIVE STRUCTURE CERTIFICATION

Performance certified at date of manufacture to:

OSHA: 1926.1001;1910.266

SAE: J1040MAY1994, J1043SEP99

ISO: 34491992-05-15, Level 1;3474 1994-02-01

MAXIMUM MACHINE WEIGHT 4,500 Kg (10,000 LBS)

John Deere Skid Steer Models: 240, 250, 260, 270 and 280

Deere & Company; Moline Illinois

Operator Training Required

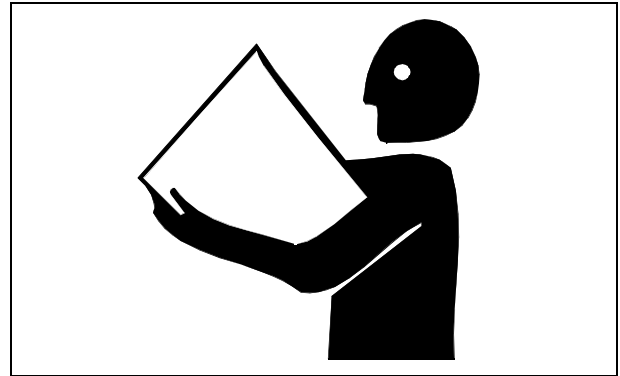

MIF

- Study operation section of this manual before operating the machine. Know location and function of all controls.
- Operate machine in an open, unobstructed area under the direction of an experienced operator.
- Operator experience is required to learn the moving, stopping, turning, and other operating characteristics of the machine.
- Safety Video, DSVHC018312, is available through your John Deere Dealer.

Use Seat Belt Properly

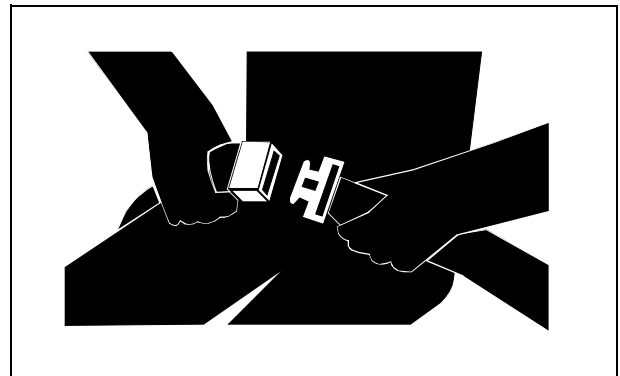

MIF

- Use a seat belt when you operate with a roll-over protective structure (ROPS) or cab to minimize chance of injury from an accident such as an overturn.
- Do not operate skid steer from anywhere but the operator's seat with seat belt fastened.

Buy Now



Our support email:

ebooklibonline@outlook.com