

**JOHN DEERE**  
**AG & TURF DIVISION**

---

**Compact Utility Tractor**  
**4120, 4320, 4520, 4720**

OMLVU24810 E2

**OPERATOR'S MANUAL**

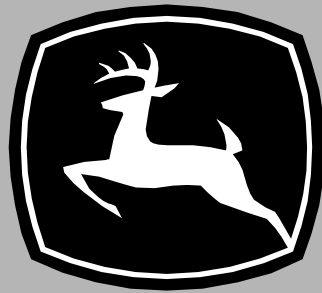

**JOHN DEERE**

**⚠ WARNING:** Diesel engine exhaust and some of its constituents are known to the State of California to cause cancer, birth defects, and other reproductive harm.

California Proposition 65 Warning

North American Version  
Litho in U.S.A.

# Introduction

---

## Thank You for Purchasing a John Deere Product

We appreciate having you as a customer and wish you many years of safe and satisfied use of your machine.

## Using Your Operator's Manual

This manual is an important part of your machine and should remain with the machine when you sell it.

Reading your operator's manual will help you and others avoid personal injury or damage to the machine. Information given in this manual will provide the operator with the safest and most effective use of the machine. Knowing how to operate this machine safely and correctly will allow you to train others who may operate this machine.

If you have an attachment, use the safety and operating information in the attachment operator's manual along with the machine operator's manual to operate the attachment safely and correctly.

This manual and safety signs on your machine may also be available in other languages (see your authorized dealer to order).

**An online operational video** is available for your machine through the Internet. To view this video, go to [www.JohnDeere.com/OperationalVideos](http://www.JohnDeere.com/OperationalVideos) and click on the link for your machine model.

Sections in your operator's manual are placed in a specific order to help you understand all the safety messages and learn the controls so you can operate this machine safely. You can also use this manual to answer any specific operating or servicing questions. A convenient index located at the end of this book will help you to find needed information quickly.

The machine shown in this manual may differ slightly from your machine, but will be similar enough to help you understand our instructions.

RIGHT-HAND and LEFT-HAND sides are determined by facing in the direction the machine will travel when going forward. When you see a broken line (-----), the item referred to is hidden from view.

Before delivering this machine, your dealer performed a predelivery inspection to ensure best performance.

## Special Messages

Your manual contains special messages to bring attention to potential safety concerns, machine damage as well as helpful operating and servicing information. Please read all the information carefully to avoid injury and machine

damage.



**CAUTION: Avoid injury! This symbol and text highlight potential hazards or death to the operator or bystanders that may occur if the hazards or procedures are ignored.**

**IMPORTANT: Avoid damage! This text is used to tell the operator of actions or conditions that might result in damage to the machine.**

**NOTE: General information is given throughout the manual that may help the operator in the operation or service of the machine.**

## Attachments for Your Machine

There's a John Deere attachment or kit to make your new machine perform more tasks or be more versatile, whether your machine is a lawn tractor or compact utility tractor or a utility vehicle.

You can check out the entire line of attachments for your machine at [JohnDeere.com](http://JohnDeere.com) or ask your John Deere dealer. From aerators to electric lift kits to tillers, there's a John Deere attachment or kit to fill every need.

# Product Identification

## Record Identification Numbers

### Compact Utility Tractor

Open Station Models PIN (810481 -)

Cab Models PIN (840001 -)

If you need to contact an Authorized Service Center for information on servicing, always provide the product model and identification numbers.

You will need to locate the identifications numbers for the product. Record the information in the spaces provided below.

DATE OF PURCHASE:

\_\_\_\_\_

DEALER NAME:

\_\_\_\_\_

DEALER PHONE:

\_\_\_\_\_

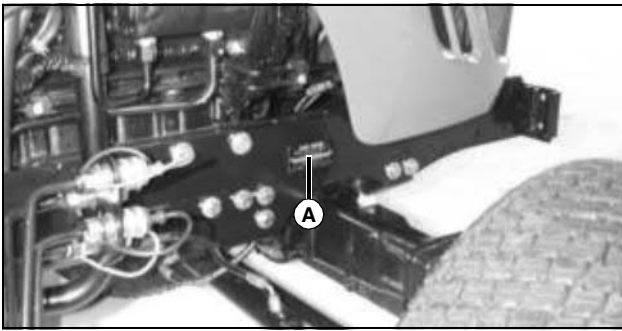

MX20634

PRODUCT IDENTIFICATION NUMBER (A):

\_\_\_\_\_

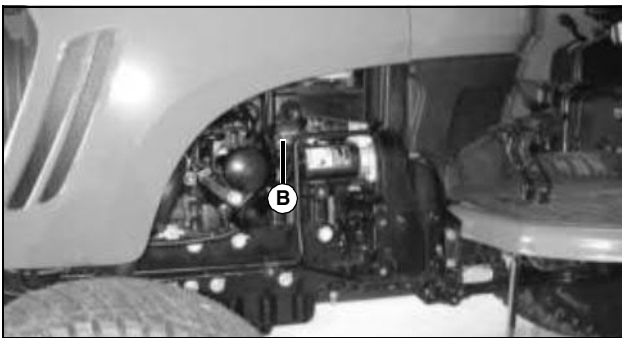

MX20635

ENGINE SERIAL NUMBER (B):

\_\_\_\_\_

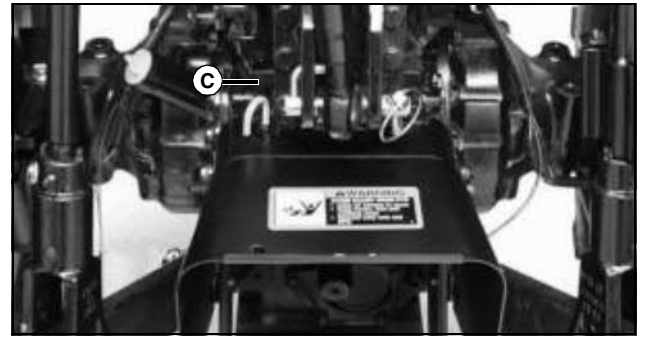

MX4778

TRANSMISSION SERIAL NUMBER (C):

\_\_\_\_\_

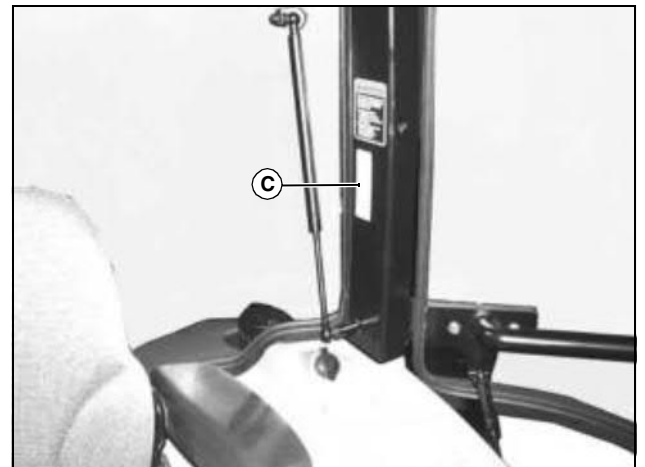

MX35852

CAB SERIAL NUMBER (D):

\_\_\_\_\_

# Table of Contents

---

Safety Labels .....	1
Safety .....	7
Operating - Controls .....	20
Operating .....	24
Replacement Parts .....	62
Service Intervals .....	63
Service Lubrication .....	65
Service Engine .....	66
Service Transmission .....	77
Service Steering & Brakes .....	82
Service Electrical .....	84
Service Miscellaneous .....	94
Troubleshooting .....	103
Storage .....	112
Specifications .....	113
Warranty .....	120
Index .....	123

Original Instruction

All information, illustrations and specifications in this manual are based on the latest information at the time of publication. The right is reserved to make changes at any time without notice.

COPYRIGHT© 2012

Deere & Co.

John Deere Ag & Turf Division

All rights reserved

Previous Editions

COPYRIGHT© 2011

OMLVU24810 E2 -

# Safety Labels

## Safety Label Location

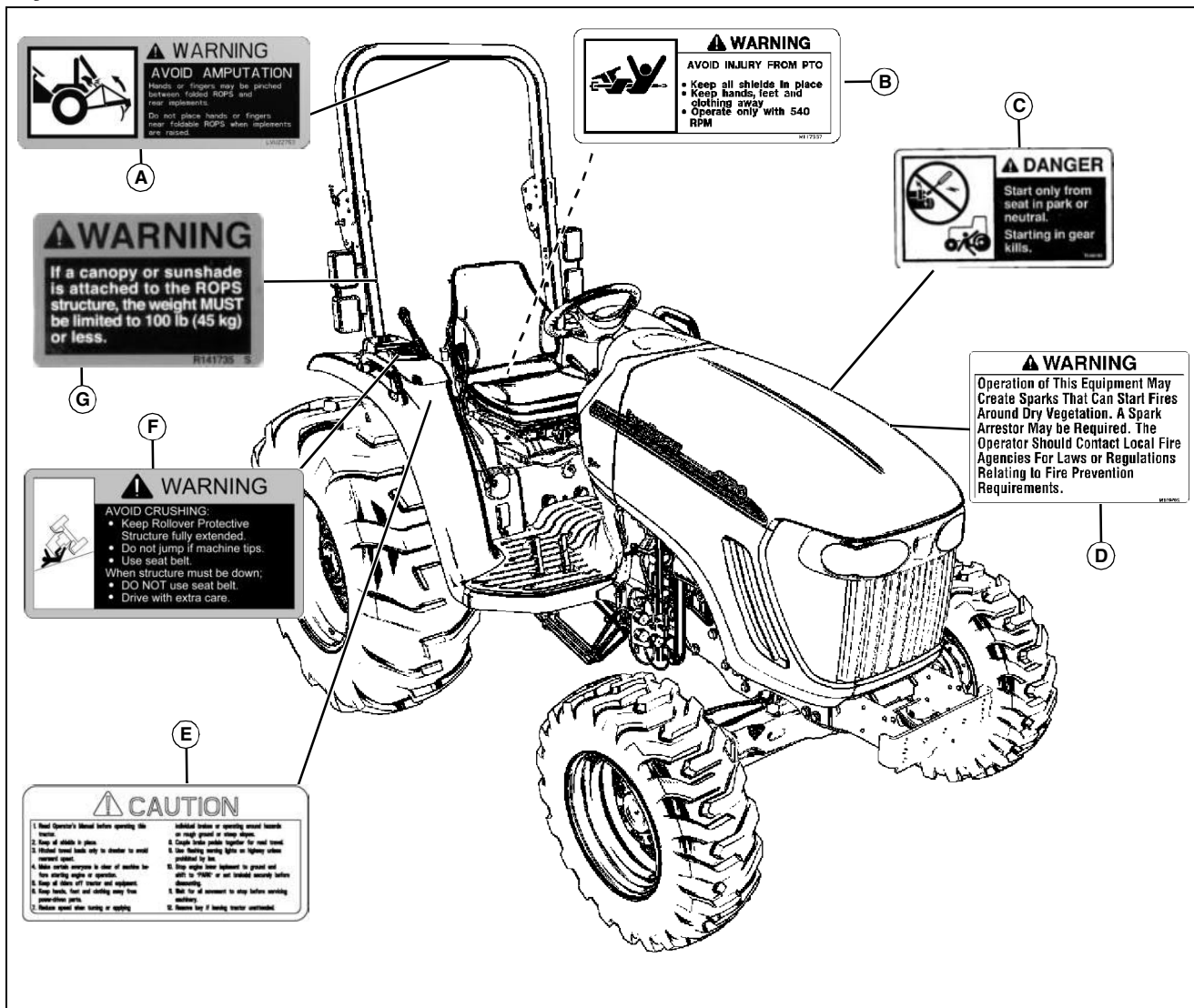

MX40881

**Picture Note:** Use label number listed in table below to locate complete text of safety label message following this illustration.

- A - WARNING LVU22753**
- B - WARNING M117557**
- C - DANGER T146195**
- D - WARNING M159705**
- E - CAUTION LVU10708**
- F - WARNING LVU10709**
- G - WARNING R141735**

# Safety Labels

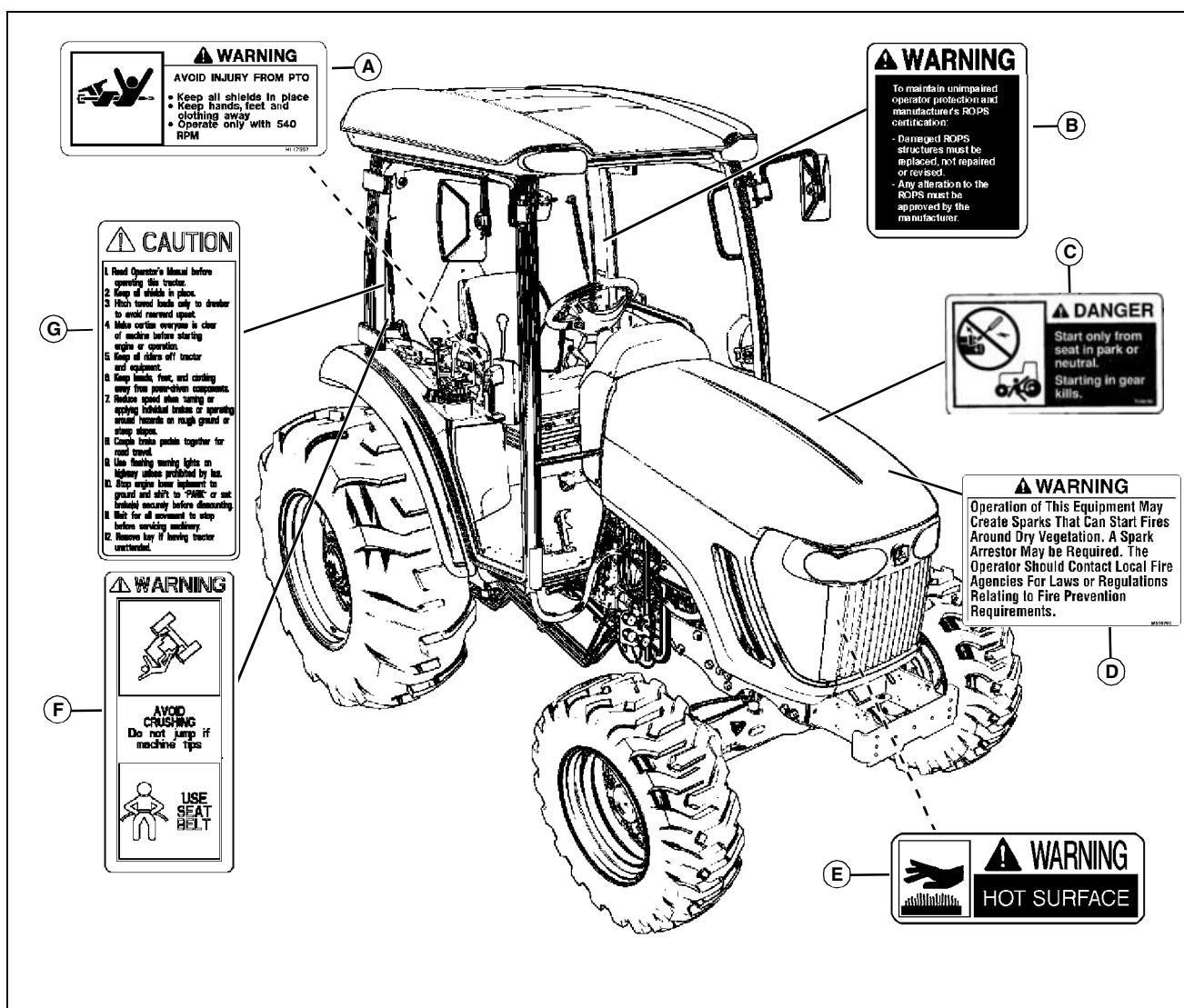

MX40883

**Picture Note:** Use label number listed in table below to locate complete text of safety label message following this illustration.

- A - WARNING M117557**
- B - WARNING R120124**
- C - DANGER T146195**
- D - WARNING M159705**
- E - WARNING M117554**
- F - WARNING LVU10707**
- G - CAUTION MIU10747**

machine to draw attention to potential safety hazards.

On your machine safety labels, the words DANGER, WARNING, and CAUTION are used with this safety-alert symbol. DANGER identifies the most serious hazards.

The operator's manual also explains any potential safety hazards whenever necessary in special safety messages that are identified with the word, CAUTION, and the safety-alert symbol.



## Understanding The Machine Safety Labels

The machine safety labels shown in this section are placed in important areas on your

# Safety Labels

## DANGER T146195



T146195

Start only from seat in park or neutral.

Starting in gear kills.

## WARNING AVOID CRUSHING LVU10709



LVU10709

- Keep Rollover Protective Structure fully extended.
- Do not jump if machine tips.
- Use seat belt.

When structure must be down;

- DO NOT use seat belt.
- Drive with extra care.

## WARNING ROPS R141735



R141735

If a canopy or sunshade is attached to the ROPS structure, the weight MUST be limited to 100 lb (45 kg) or less.

## WARNING ROPS R120124



R120124

To maintain unimpaired operator protection and manufacturer's ROPS certification:

- Damaged ROPS structures must be replaced, not repaired or revised.
- Any alteration to the ROPS must be approved by the manufacturer.

## WARNING LVU22753

### AVOID AMPUTATION



LVU22753

- Hands or fingers may be pinched between folded ROPS and rear implements. Do not place hands or fingers near foldable ROPS when implements are raised.

## Safety Labels

### WARNING M117554



M117554

Hot surface

### WARNING M117557



M117557

#### AVOID INJURY FROM PTO.

- Keep all shields in place.
- Keep hands, feet and clothing away.
- Operate only with 540 RPM.

### CAUTION READ OPERATORS MANUAL LVU10708

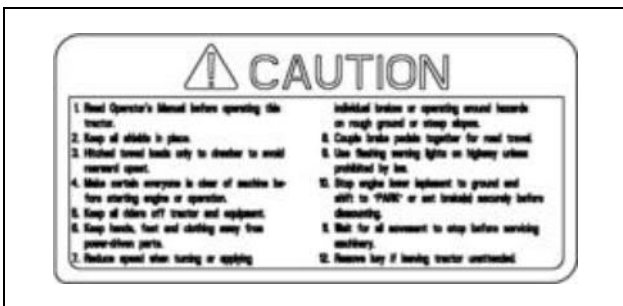

LVU10708

1. Read Operator's Manual before operating this machine.
2. Keep all shields in place.
3. Hitch towed loads only to drawbar to avoid rearward upset.
4. Make certain everyone is clear of machine before

starting engine or operation.

5. Keep all riders off machine and equipment.
6. Keep hands, feet and clothing away from power-driven parts.
7. Reduce speed when turning or applying individual brakes or operating around hazards on rough ground or steep slopes.
8. Couple brake pedals together for road travel.
9. Use flashing warning lights on highway unless prohibited by law.
10. Stop engine, lower implement to ground and shift to "PARK" or set brake(s) securely before dismounting.
11. Wait for all movement to stop before servicing machinery.
12. Remove key if leaving machine unattended.

### CAUTION READ OPERATORS MANUAL MIU10747



MIU10747

1. Read the operator's manual before operating the tractor.
2. Keep all shields in place.
3. Hitch towed loads only to drawbar to avoid rearward upset.
4. Make sure everyone is clear of machine before starting engine or operation.
5. Keep all riders off tractor and equipment.
6. Keep hands, feet, and clothing away from power-driven components.



# Safety Labels

7. Reduce speed when turning or applying individual brakes or operating around hazards on rough ground or steep slopes.
8. Couple brake pedals together for road travel.
9. Use flashing warning lights on highway unless prohibited by law.
10. Stop engine lower implement to ground and shift to "PARK" or set brake(s) securely before dismounting.
11. Wait for all movement to stop before servicing machinery.
12. Remove key if leaving tractor unattended.

## WARNING LVU22753

### AVOID AMPUTATION



LVU22753

- Hands or fingers may be pinched between folded ROPS and rear implements. Do not place hands or fingers near foldable ROPS when implements are raised.

## CAUTION LVU22771

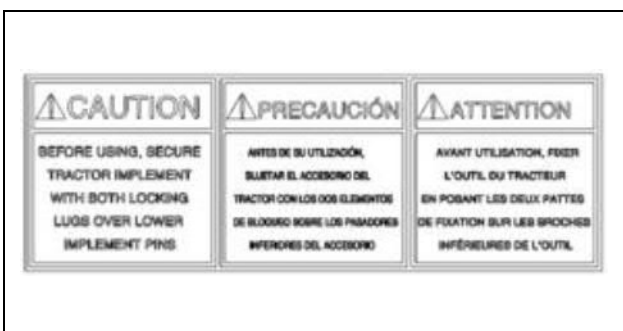

LVU22771

**Picture Note: Optional iMatch quick-attach hitch.**

BEFORE USING, SECURE TRACTOR IMPLEMENT WITH BOTH LOCKING LUGS OVER LOWER IMPLEMENT PINS

## Warning M159705



M159705

**Picture Note: This label is required and installed on machines sold in California. This label may also be installed on machines sold in other locations.**

Operation of This Equipment May Create Sparks that Can Start Fires Around Dry Vegetation. A Spark Arrestor May be Required. The Operator Should Contact Local Fire Agencies For Laws or Regulations Relating to Fire Prevention Requirements.

## Emissions Control System Certification Label

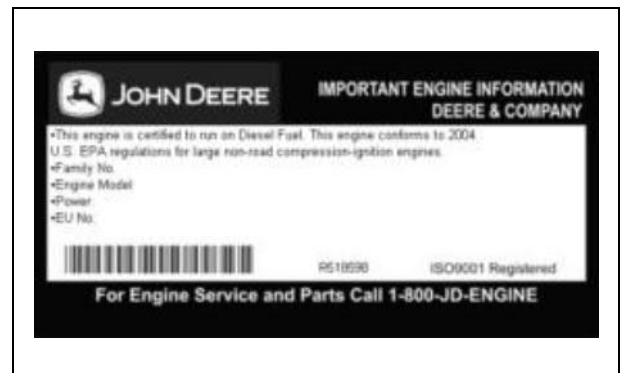

R518598

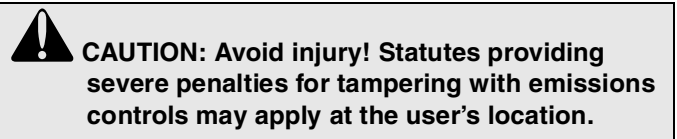

The emissions warranty described in the warranty section applies only to those engines marketed by John Deere that have been certified by the United States Environmental Protection Agency (EPA) and/or California Air Resources Board (CARB); and used in the United States and Canada in non-road mobile (self-propelled or portable/transportable<sup>1</sup>) equipment. The presence of an emissions label like the one shown signifies that the engine has been certified with the EPA and/or CARB. The EPA and CARB warranties only apply to new engines having the

<sup>1</sup>. Equipment moved at least once every 12 months.

## Safety Labels

---

certification label affixed to the engine and sold as stated above in the geographic areas. The presence of an EU number on the label signifies that the engine has been certified with the European Union countries per Directive 97/68/EC. The emissions warranty does not apply to the EU countries.

***NOTE: The hp/kW rating on the engine emissions certification label specifies the gross engine hp/kW, which is flywheel power without fan. In most applications this will not be the same rating as the advertised vehicle hp/kW rating.***

# Safety



## Recognize Safety Information

This is a safety-alert symbol. When you see this symbol on your machine or in this manual, be alert to the potential for personal injury.

Follow recommended precautions and safe operating practices.

## Understand Signal Words

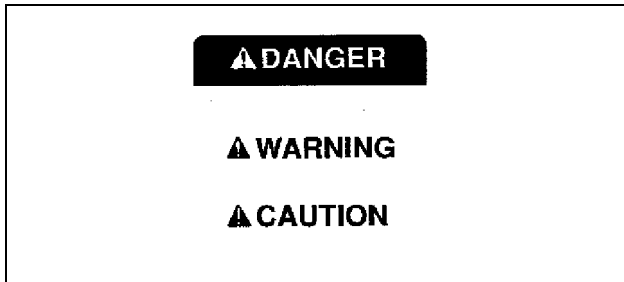

A signal word-DANGER, WARNING, or CAUTION-is used with the safety-alert symbol. DANGER identifies the most serious hazards.

DANGER or WARNING safety signs are located near specific hazards. General precautions are listed on CAUTION safety signs. CAUTION also calls attention to safety messages in this manual.

## Follow Safety Instructions

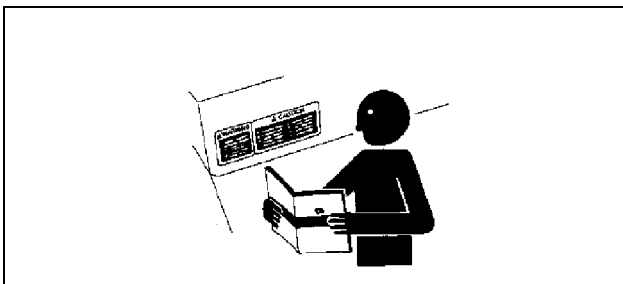

Carefully read all safety messages in this manual and on your machine safety signs. Keep safety signs in good condition. Replace missing or damaged safety signs. Be sure new equipment components and repair parts include the current safety signs. Replacement safety signs are available from your John Deere dealer.

There can be additional safety information contained on parts and components sourced from suppliers that is not reproduced in this operator's manual.

Learn how to operate the machine and how to use controls properly. Do not let anyone operate without instruction.

Keep your machine in proper working condition. Unauthorized modifications to the machine may impair the function and/or safety and affect machine life.

If you do not understand any part of this manual and need assistance, contact your John Deere dealer.

## Prepare for Emergencies

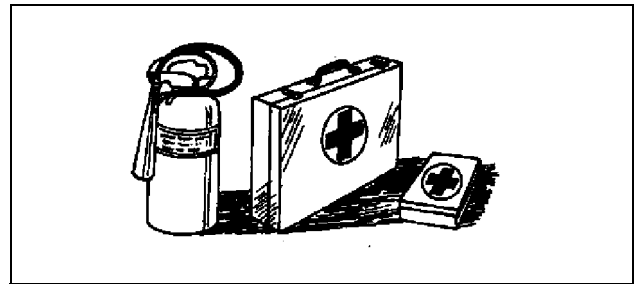

Be prepared if a fire starts.

Keep a first aid kit and fire extinguisher handy.

Keep emergency numbers for doctors, ambulance service, hospital, and fire department near your telephone.

## Wear Protective Clothing

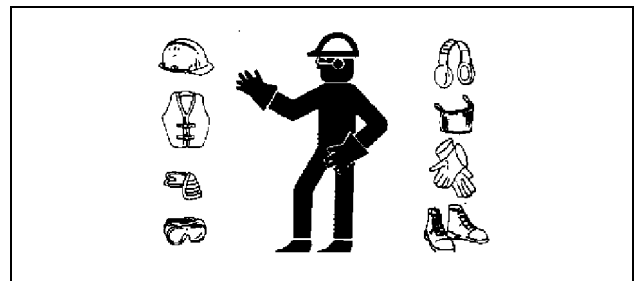

Wear close fitting clothing and safety equipment appropriate to the job.

Operating equipment safely requires the full attention of the operator. Do not wear radio or music headphones while operating machine.

# Safety

## Protect Against Noise

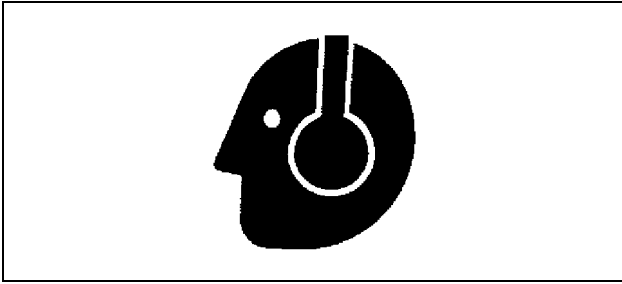

Prolonged exposure to loud noise can cause impairment or loss of hearing.

Wear a suitable hearing protective device such as earmuffs or earplugs to protect against objectionable or uncomfortable loud noises.

## Handle Fuel Safely - Avoid Fires



Handle fuel with care: it is highly flammable. Do not refuel the machine while smoking or when near open flame or sparks.

Always stop engine before refueling machine. Fill fuel tank outdoors.

Prevent fires by keeping machine clean of accumulated trash, grease, and debris. Always clean up spilled fuel.

Use only an approved fuel container for transporting flammable liquids.

Never fill fuel container in pickup truck with plastic bed liner. Always place fuel container on ground before refueling. Touch fuel container with fuel dispenser nozzle before removing can lid. Keep fuel dispenser nozzle in contact with fuel container inlet when filling.

Do not store fuel container where there is an open flame spark, or pilot light such as within a water heater or other appliance.

## Handle Starting Fluid Safely

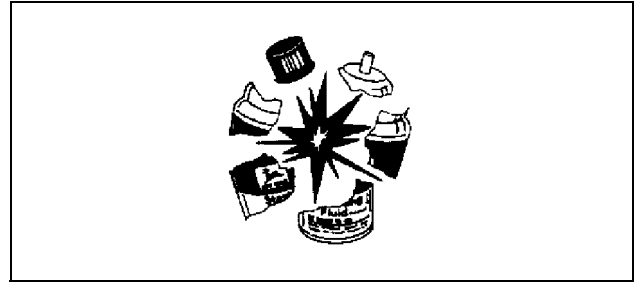

Starting fluid is highly flammable.

Keep all sparks and flame away when using it. Keep starting fluid away from batteries and cables.

To prevent accidental discharge when storing the pressurized can, keep the cap on the container, and store in a cool, protected location.

Do not incinerate or puncture a starting fluid container.

## Fire Prevention

To reduce the risk of fire, your tractor should be regularly inspected and cleaned.

- Birds and other animals may build nests or bring other flammable materials into the engine compartment or onto the exhaust system. The tractor should be inspected and cleaned prior to the first use each day.
- A build up of grass, crop material and other debris may occur during normal operation. This is especially true when operating in very dry conditions or conditions where airborne crop material or crop dust is present. Any such build up must be removed to ensure proper machine function and to reduce the risk of fire. The tractor must be inspected and cleaned periodically throughout the day.
- Regular and thorough cleaning of the tractor combined with other routine maintenance procedures listed in the Operator's Manual greatly reduce the risk of fire and the chance of costly downtime.
- Do not store fuel container where there is an open flame, spark, or pilot light such as within a water heater or other appliance.
- Check fuel lines, tank, cap, and fittings frequently for damage, cracks or leaks. Replace if necessary.

Follow all operational and safety procedures posted on the machine and the Operator's Manual. Be careful of hot engine and exhaust components during inspection and cleaning. Before carrying out any inspection or cleaning, always shut OFF the engine, place the transmission in PARK or set parking brake, and remove the key. Removal of the key will prevent others from starting the tractor during

# Safety

inspection and cleaning.

## Keep ROPS Installed Properly

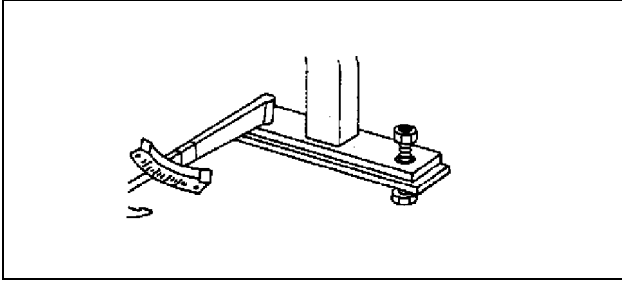

Make certain all parts are reinstalled correctly if the roll-over protective structure (ROPS) is loosened or removed for any reason. Tighten mounting bolts to proper torque.

The protection offered by ROPS will be impaired if ROPS is subjected to structural damage, is involved in an overturn incident, or is in any way altered by welding, bending, drilling, or cutting. A damaged ROPS should be replaced, not reused.

The seat is part of the ROPS safety zone. Replace only with John Deere seat approved for your tractor.

Any alteration of the ROPS must be approved by the manufacturer.

## Use Foldable ROPS and Seat Belt Properly

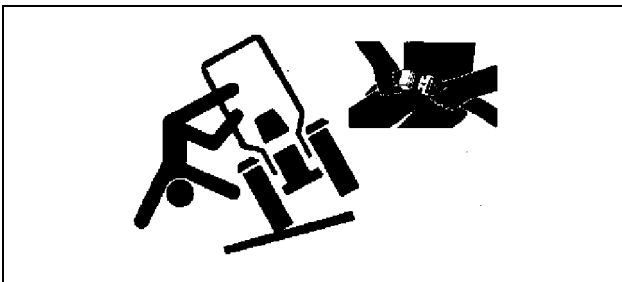

If this tractor is equipped with a foldable ROPS, keep the ROPS in the fully extended and locked position. If the tractor is ever operated with ROPS folded (e.g., to enter a low building), drive with extreme caution. Do NOT use seat belt with the ROPS folded.

Return the ROPS to the raised, fully extended and locked position as soon as the tractor is operated under normal conditions. Always fasten your seat belt when the ROPS is fully extended and locked.

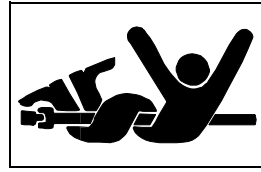

## Stay Clear of Rotating Drivelines

Entanglement in rotating driveline can cause serious injury or death.

Keep tractor master shield and driveline shields in place at all times. Make sure rotating shields turn freely.

Wear close fitting clothing. Stop the engine and be sure PTO driveline is stopped before making adjustments, connections, or cleaning out PTO driven equipment.

Do not install any adapter device between the tractor and the primary implement PTO drive shaft that will allow a 1000 rpm tractor shaft to power a 540 rpm implement at speeds higher than 540 rpm.

Do not install any adapter device that results in a portion of the rotating implement shaft, tractor shaft, or the adapter to be unguarded. The tractor master shield shall overlap the end of the splined shaft and the added adaptor device as outlined in the table.

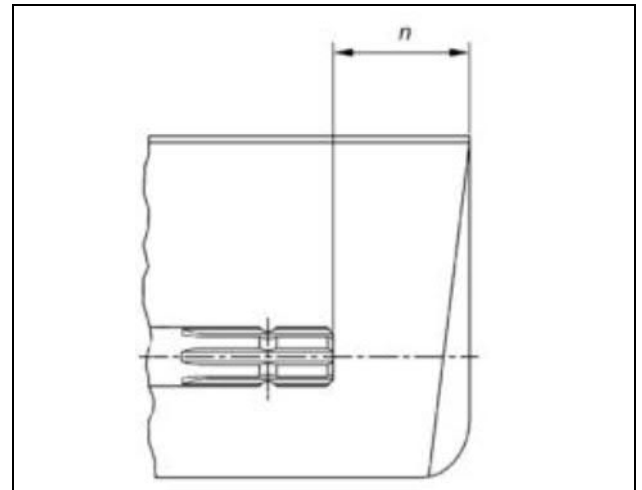

PTO Type	Diameter	Splines	n ± 5mm (0.20 in.)
1	35 mm (1.378 in.)	6	85 mm (3.35 in.)
2	35 mm (1.378 in.)	21	85 mm (3.35 in.)
3	45 mm (1.772 in.)	20	100 mm (4.00 in.)

# Safety



## Use Steps and Handholds Correctly

Prevent falls by facing the machine when getting on and off. Maintain 3-point contact with steps and handrails. Never use machine controls as handholds.

Use extra care when mud, snow, or moisture present slippery conditions. Keep steps clean and free of grease or oil. Never jump when exiting machine. Never mount or dismount a moving machine.

## Read Operator Manuals for ISOBUS Implements

In addition to GreenStar Applications, this display can be used as a display device for any implement that meets ISO 11783 standard. This includes capability to control ISOBUS implements. When used in this manner, information and implement control functions placed on the display are provided by the implement and are the responsibility of the implement manufacturer. Some of these implement functions could provide a hazard either to the Operator or a bystander. Read the operator manual provided by the implements manufacturer and observe all safety messages in manual and on implement prior to use.

NOTE: ISOBUS refers to the ISO Standard 11783.

## Use Seat Belt Properly

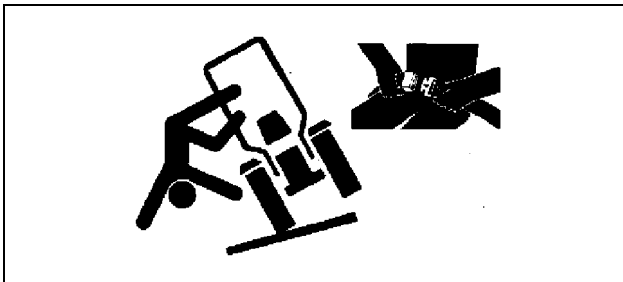

Use a seat belt when you operate with a roll-over protective structure (ROPS) or cab to minimize chance of injury from an accident such as an overturn.

Do not use a seat belt if operating without a ROPS or cab.

Replace entire seat belt if mounting hardware, buckle, belt, or retractor show signs of damage.

Inspect seat belt and mounting hardware at least once a year. Look for signs of loose hardware or belt damage, such as cuts, fraying, extreme or unusual wear, discoloration, or abrasion. Replace only with replacement parts approved for your machine. See your John Deere dealer.

## Operating the Tractor Safely



You can reduce the risk of accidents by following these simple precautions:

- Use your tractor only for jobs it was designed to perform, for example, pushing, pulling, towing, actuating, and carrying a variety of interchangeable equipment designed to conduct agricultural work.
- This tractor is not intended to be used as a recreational vehicle.
- Read this operator's manual before operating the tractor and follow operating and safety instructions in the manual and on the tractor.
- Follow operation and ballasting instructions found in the operator's manual for your implements/attachments, such as front loaders
- Make sure that everyone is clear of machine, attached equipment, and work area before starting engine or operation.
- Keep hands, feet, and clothing away from power-driven parts.

## Driving Concerns

- Never get on or off a moving tractor.
- Keep all children and nonessential personnel off tractors and all equipment.
- Never ride on a tractor unless seated on a John Deere approved seat with seat belt.
- Keep all shields/guards in place.
- Use appropriate visual and audible signals when operating on public roads.
- Move to side of road before stopping.
- Reduce speed when turning, applying individual brakes,

**Buy Now**



Our support email:

[ebooklibonline@outlook.com](mailto:ebooklibonline@outlook.com)