

Product: TRUCK

Model: 793C TRUCK ATY

Configuration: 793C Off-Highway Truck ATY00001-UP (MACHINE) POWERED BY 3516 Engine

Disassembly and Assembly

3500 and 3500B High Displacement Engines for Caterpillar Built Machines

Media Number -SEN1126-33

Publication Date -01/07/2015

Date Updated -14/09/2018

i02928334

Engine Oil Sequence Valves - Remove and Install

SMCS - 1332-010

Removal Procedure

Start By:

- a. Remove the front drive housing. Refer to Disassembly and Assembly, "Front Drive Housing - Remove and Install" or Disassembly and Assembly, "Drive Housing (Front) - Remove and Install".
- b. Remove the flywheel housing. Refer to Disassembly and Assembly, "Flywheel Housing - Remove".

NOTICE

Keep all parts clean from contaminants.

Contaminants may cause rapid wear and shortened component life.

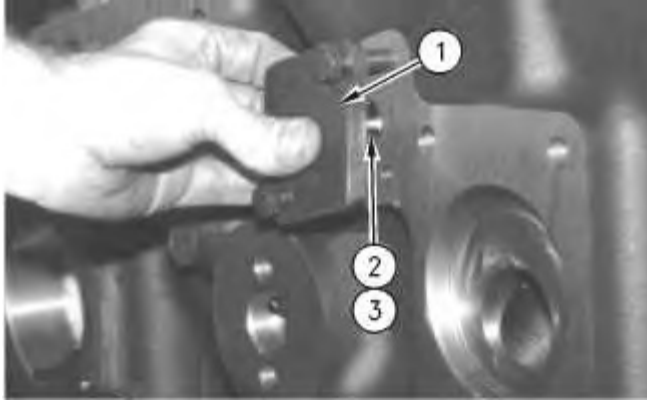

Illustration 1

g00912963

WARNING

Personal injury can result from parts and/or covers under spring pressure.

Spring force will be released when covers are removed.

Be prepared to hold spring loaded covers as the bolts are loosened.

1. Remove cover (1) from the front of the cylinder block.
2. Remove plunger assembly (2) and spring (3) from the front of the cylinder block.

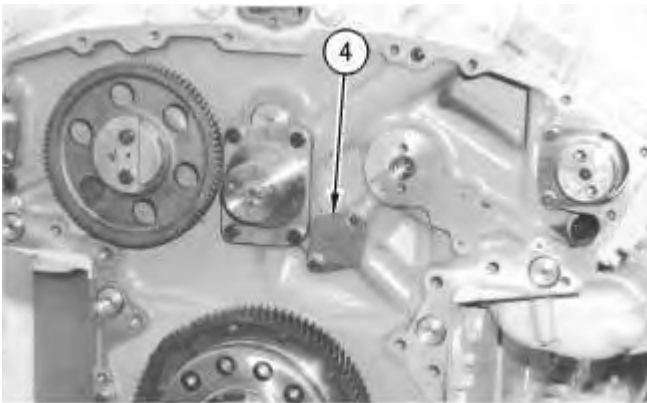

Illustration 2

g00912966

WARNING

Personal injury can result from parts and/or covers under spring pressure.

Spring force will be released when covers are removed.

Be prepared to hold spring loaded covers as the bolts are loosened.

3. Remove the idler gear and the shaft. Remove cover (4) on the rear of the cylinder block.

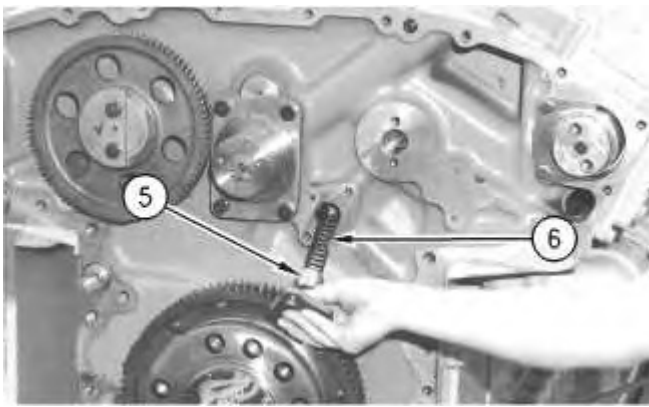

Illustration 3

g00912969

4. Remove plunger assembly (5) and spring (6) from the rear of the cylinder block.

Installation Procedure

NOTICE

Keep all parts clean from contaminants.

Contaminants may cause rapid wear and shortened component life.

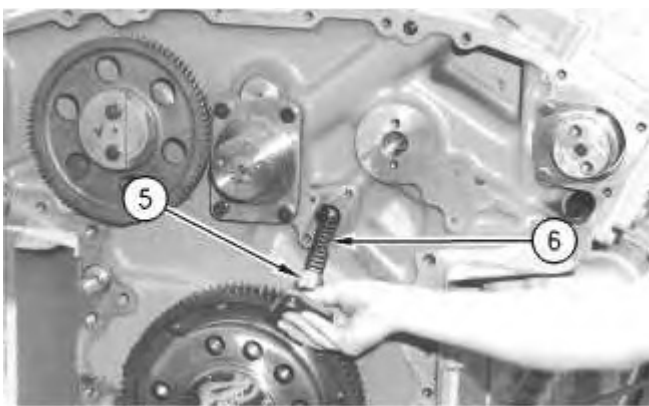

Illustration 4

g00912969

1. Place clean engine oil on spring (6) and plunger assembly (5).
2. Install spring (6) and plunger assembly (5).

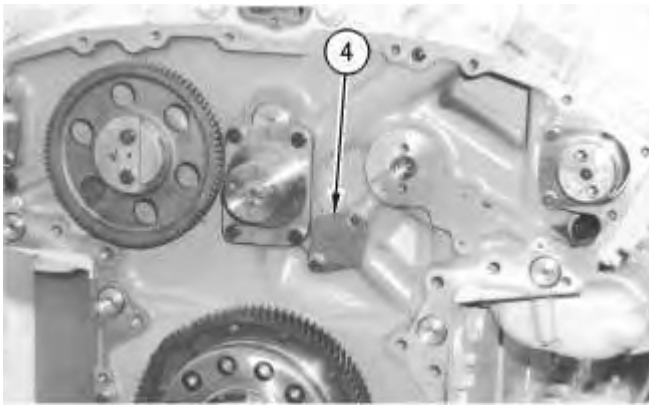

Illustration 5

g00912966

 **WARNING**

Improper assembly of parts that are spring loaded can cause bodily injury.

To prevent possible injury, follow the established assembly procedure and wear protective equipment.

3. Install cover (4) on the rear of the cylinder block. Install the idler gear and the shaft.

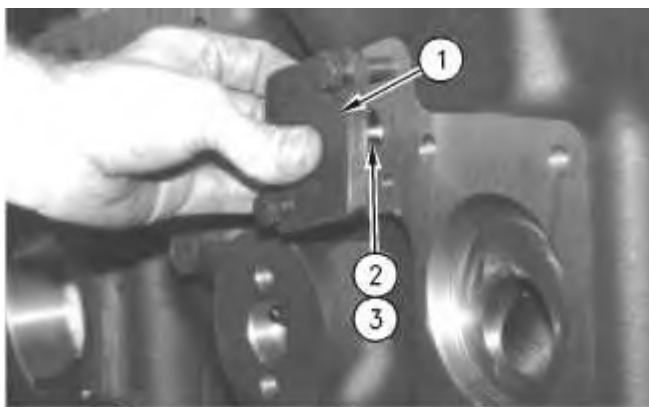

Illustration 6

g00912963

 **WARNING**

Improper assembly of parts that are spring loaded can cause bodily injury.

To prevent possible injury, follow the established assembly procedure and wear protective equipment.

4. Place clean engine oil on spring (3) and plunger assembly (2).
5. Install spring (3) and plunger assembly (2) on the front of the cylinder block.
6. Install cover (1) on the front of the cylinder block.

End By:

- a. Install the flywheel housing. Refer to Disassembly and Assembly, "Flywheel Housing - Install".
 - b. Install the front drive housing. Refer to Disassembly and Assembly, "Front Drive Housing - Remove and Install" or Disassembly and Assembly, "Drive Housing (Front) - Remove and Install".
-

Product: TRUCK

Model: 793C TRUCK ATY

Configuration: 793C Off-Highway Truck ATY00001-UP (MACHINE) POWERED BY 3516 Engine

Disassembly and Assembly

3500 and 3500B High Displacement Engines for Caterpillar Built Machines

Media Number -SEN1126-33

Publication Date -01/07/2015

Date Updated -14/09/2018

i07085932

Gear Group (Rear) - Remove

SMCS - 1206-011; 1212-011

Removal Procedure

Table 1

Required Tools			
Tool	Part Number	Part Description	Qty
A	1P-0520	Driver Group	1

Start By:

- Remove the flywheel housing. Refer to Disassembly and Assembly, "Flywheel Housing - Remove".

NOTICE

Keep all parts clean from contaminants.

Contaminants may cause rapid wear and shortened component life.

NOTICE

Care must be taken to ensure that fluids are contained during performance of inspection, maintenance, testing, adjusting, and repair of the product. Be prepared to collect the fluid with suitable containers before opening any compartment or disassembling any component containing fluids.

Refer to Special Publication, NENG2500, "Dealer Service Tool Catalog" for tools and supplies suitable to collect and contain fluids on Cat[®] products.

Dispose of all fluids according to local regulations and mandates.

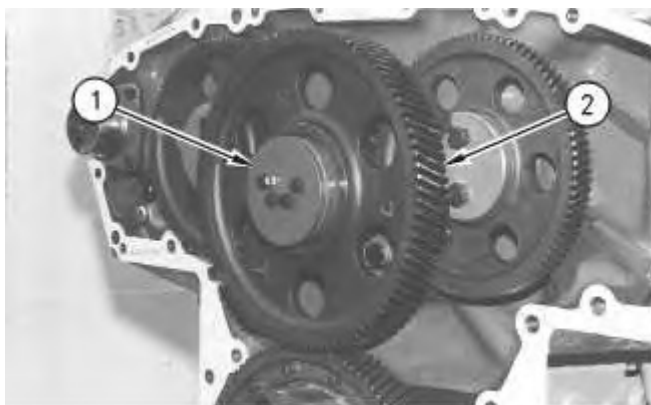

Illustration 1

g00913045

1. Remove plate (1) and gear (2).
-



Illustration 2

g00913049

2. Use Tooling (A) and a suitable press to remove bearing (3) from gear (2).
-

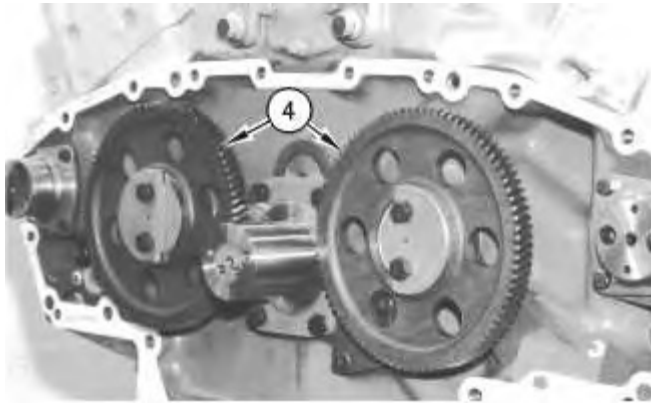

Illustration 3

g00913054

3. Remove the bolts, the washers, and camshaft idler gears (4).

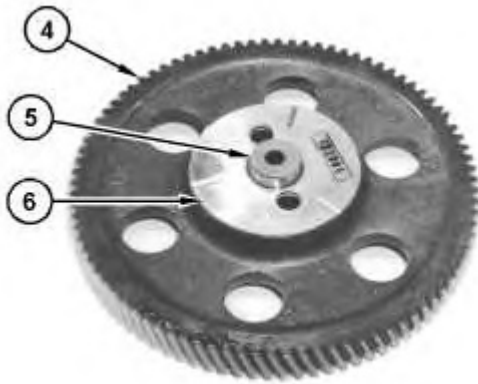

Illustration 4

g01051669

4. Remove washers (6) and shafts (5) from camshaft idler gears (4).
5. Use Tooling (A) and a suitable press to remove bearings from camshaft idler gears (4).



Illustration 5

g00913136

6. Remove the bolts from shaft (7) and remove shaft (7).

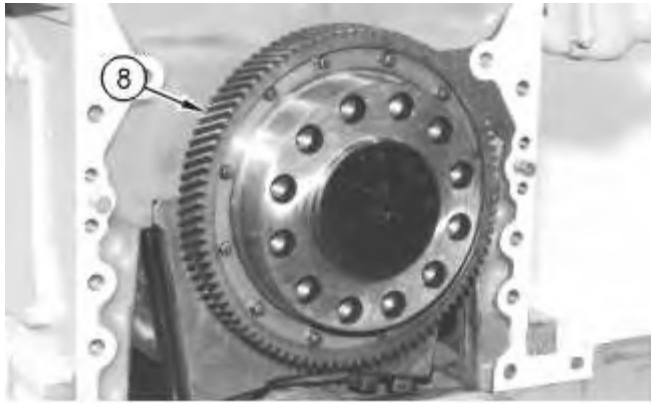

Illustration 6

g00913137

7. Remove the bolts and crankshaft gear (8) from the end of the crankshaft.
-

Product: TRUCK

Model: 793C TRUCK ATY

Configuration: 793C Off-Highway Truck ATY00001-UP (MACHINE) POWERED BY 3516 Engine

Disassembly and Assembly

3500 and 3500B High Displacement Engines for Caterpillar Built Machines

Media Number -SEN1126-33

Publication Date -01/07/2015

Date Updated -14/09/2018

i04014109

Gear Group (Rear) - Install

SMCS - 1206-012; 1212-012

Installation Procedure

Table 1

Required Tools			
Tool	Part Number	Part Description	Qty
A	1P-0520	Driver Gp	1

NOTICE

Keep all parts clean from contaminants.

Contaminants may cause rapid wear and shortened component life.

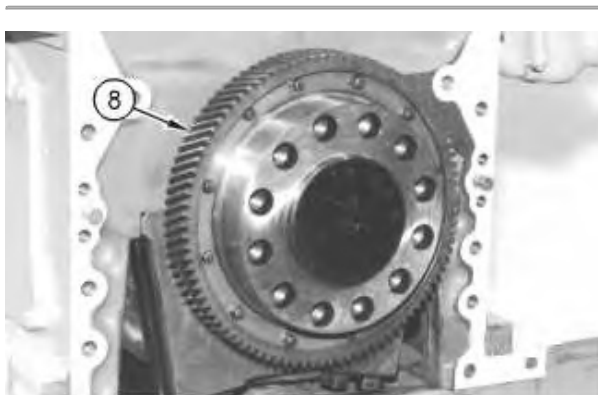

Illustration 1

g00913137

1. Install crankshaft gear (8) and the bolts.

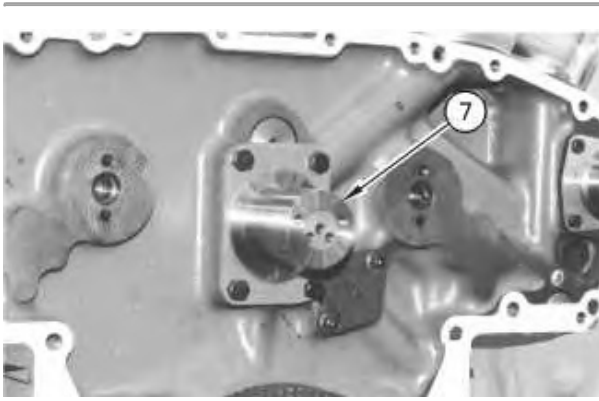

Illustration 2

g00913136

2. Install shaft (7) and the bolts. The torque for the bolts is $140 \pm 10 \text{ N}\cdot\text{m}$ ($105 \pm 5 \text{ lb ft}$).

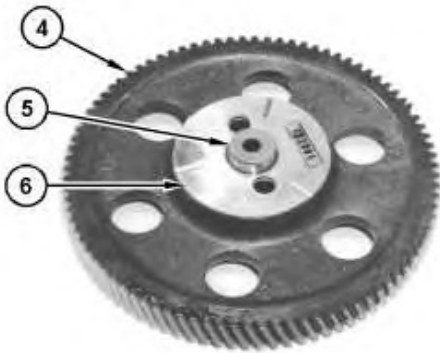

Illustration 3

g01051669

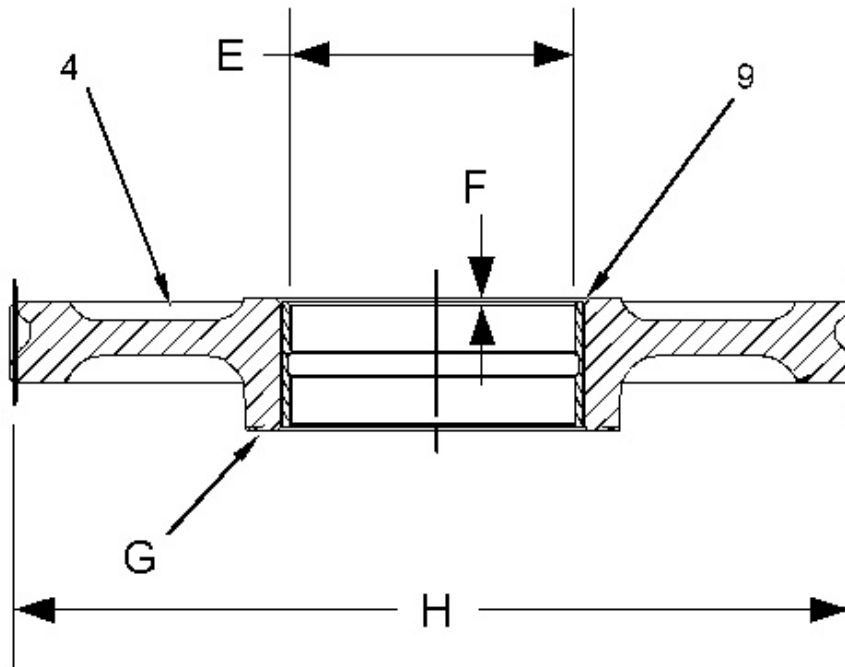

Illustration 4

g01068502

(4) Camshaft Idler Gear. (9) Bearing. (E) 81.060 ± 0.010 mm (3.1913 ± 0.0004 inch). (F) 1.00 ± 0.25 mm (0.040 ± 0.010 inch).

3. Use Tooling (A) and a suitable press to install the bearings in camshaft idler gears (4) . Install bearing (9) into gear (4) to Depth (F) , as shown.

4. Machine the inside diameter of bearing (9) to Dimension (E) , as shown.

Note: The surface finish of Bore (E) must be 0.8 micrometers. Pitch Diameter (H) must be concentric with a total indicator reading of 0.12 mm (0.005 inch). Surface (G) of gear (4) must be square with Bore (E) within 0.05 mm (0.002 inch).

5. Place clean engine oil on the bearings and install shafts (5) with washers (6) on camshaft idler gears (4) .

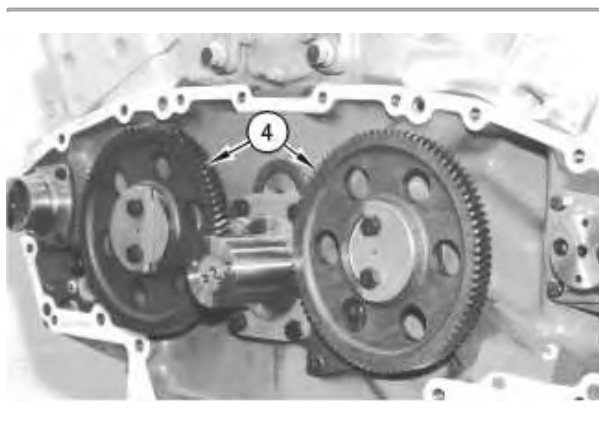

6. Install camshaft idler gears (4) and the bolts.

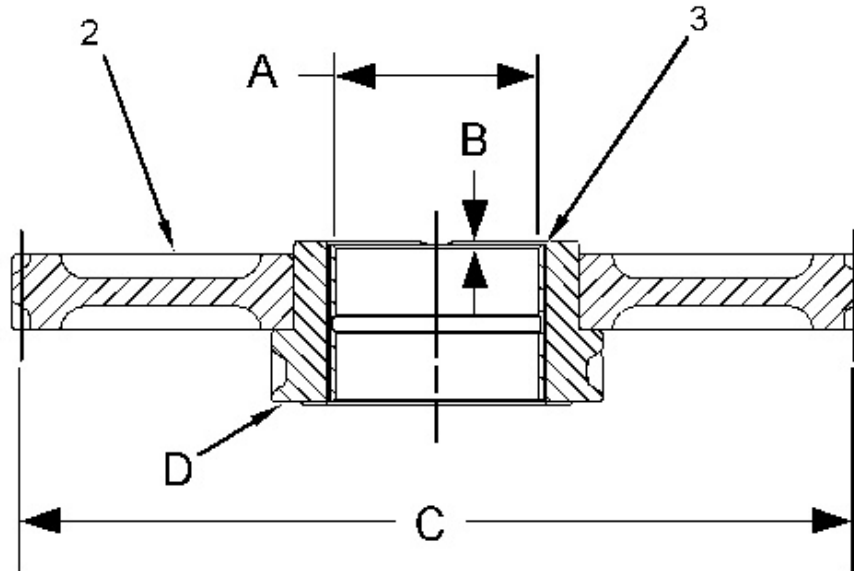

Illustration 6

g01068516

(2) Cluster Idler Gear. (3) Bearing. (A) 75.060 ± 0.010 mm (2.9551 ± 0.0004 inch). (B) 1.5 ± 0.5 mm (0.06 ± 0.02 inch).

7. Use Tooling (A) and a suitable press to install bearing (3) in gear (2) . Install bearing (3) to Depth (B) , as shown.
8. Machine the inside diameter of the bearing to Dimension (A) , as shown.

Note: The surface finish of Bore (A) must be 0.8 micrometers. Pitch Diameter (C) must be concentric with a total indicator reading of 0.15 mm (0.006 inch). Surface (D) of gear (2) must be square with Bore (A) within 0.05 mm (0.002 inch).

Note: The following Step is for 3508 and G3508 Engines.

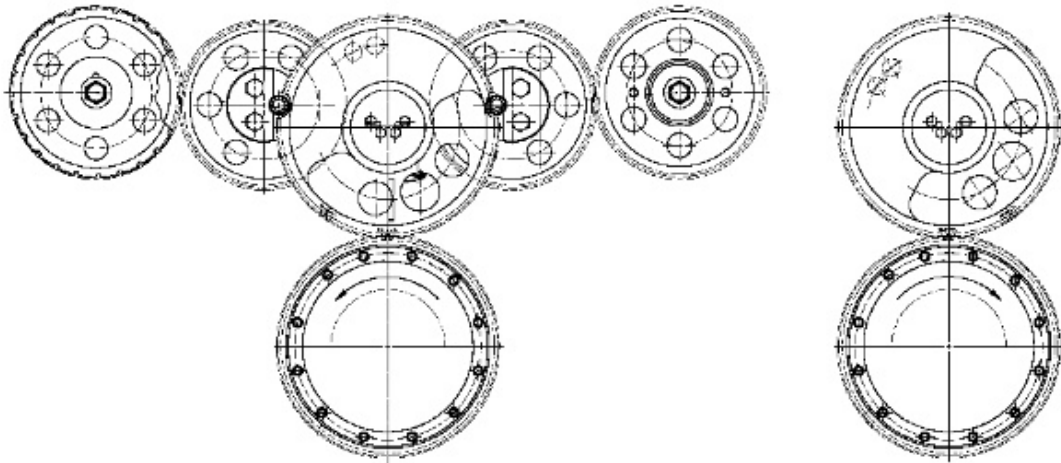

Illustration 7

g01056631

Note: When you install the rear cluster gear assembly to the crank gear, there are no timing marks on the 3512, 3516, G3512 and G3516 engines. On the 3508 and G3508 engines, the rear cluster gears have timing marks that must be aligned with the marks that are on the cluster gears.

9. Put clean engine oil on the bearing and install the gear assembly on the shaft. Make sure that the marks on the gear assembly and the crankshaft are in alignment with the rotation of the engine, as shown.

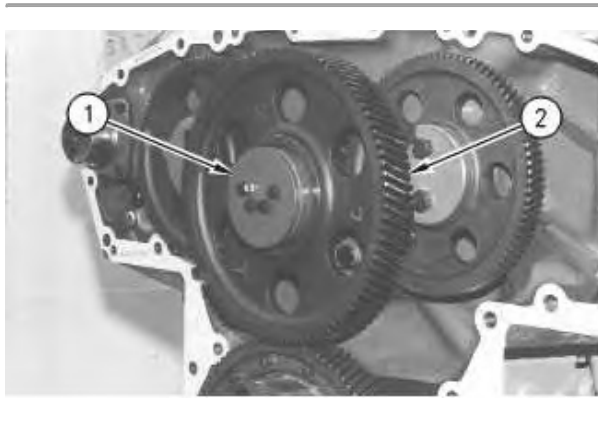

Illustration 8

g00913045

10. Place clean engine oil on gear (2) and install gear (2) on the engine.
11. Install plate (1) and the bolts.

End By: Install the flywheel housing. Refer to Disassembly and Assembly, "Flywheel Housing - Install".

Product: TRUCK

Model: 793C TRUCK ATY

Configuration: 793C Off-Highway Truck ATY00001-UP (MACHINE) POWERED BY 3516 Engine

Disassembly and Assembly

3500 and 3500B High Displacement Engines for Caterpillar Built Machines

Media Number -SEN1126-33

Publication Date -01/07/2015

Date Updated -14/09/2018

i02087195

Piston Cooling Jets - Remove and Install

SMCS - 1331

Removal Procedure

Start By:

- a. Remove the engine oil pump, if necessary. Refer to Disassembly and Assembly, "Engine Oil Pump - Remove".

NOTICE

Keep all parts clean from contaminants.

Contaminants may cause rapid wear and shortened component life.

1. Remove the cylinder block cover from the side of the engine.

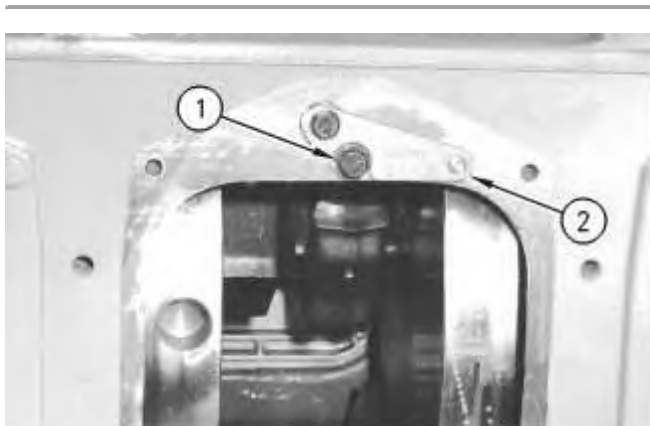

Illustration 1

g00913178

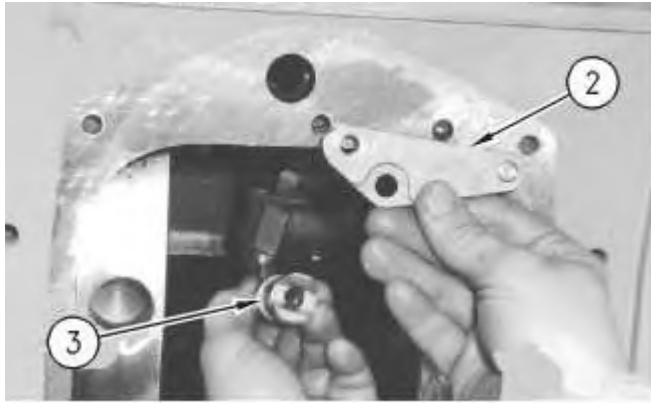

Illustration 2

g00913185

2. Remove bolts (1) and retainer (2).
3. Remove piston cooling jet (3) from the inside of the engine.

Installation Procedure

NOTICE

Keep all parts clean from contaminants.

Contaminants may cause rapid wear and shortened component life.

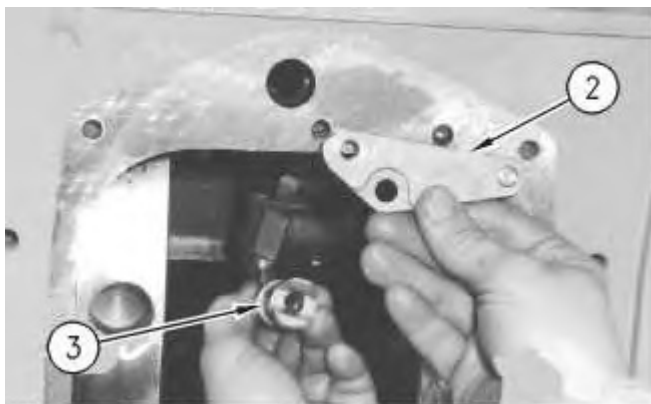

Illustration 3

g00913185

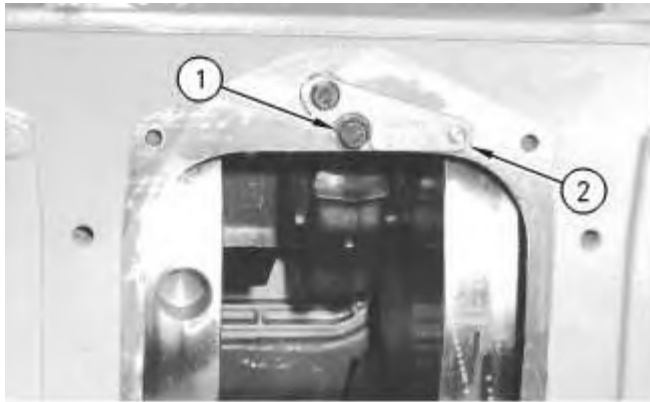

Illustration 4

g00913178

1. Position piston cooling jet (3) in the engine block. Ensure that the oil holes in the end of the jet are facing toward the piston.
2. Install retainer (2) and bolts (1).
3. Install the cylinder block cover on the side of the engine.

End By:

- a. Install the engine oil pump, if necessary. Refer to Disassembly and Assembly, "Engine Oil Pump - Install".
-

Product: TRUCK

Model: 793C TRUCK ATY

Configuration: 793C Off-Highway Truck ATY00001-UP (MACHINE) POWERED BY 3516 Engine

Disassembly and Assembly

3500 and 3500B High Displacement Engines for Caterpillar Built Machines

Media Number -SEN1126-33

Publication Date -01/07/2015

Date Updated -14/09/2018

i01793772

Bearing Clearance - Check

SMCS - 1203-535; 1219-535

Measurement Procedure

Table 1

Required Tools			
Tool	Part Number	Part Description	Qty
A	198-9142	Plastic Gauge	1
	198-9143	Plastic Gauge	1
	198-9144	Plastic Gauge	1
	198-9145	Plastic Gauge	1

NOTICE

Keep all parts clean from contaminants.

Contaminants may cause rapid wear and shortened component life.

Note: Caterpillar does not recommend the checking of the actual bearing clearances particularly on small engines. This is because of the possibility of obtaining inaccurate results and the possibility of damaging the bearing or the journal surfaces. Each Caterpillar engine bearing is quality checked for specific wall thickness.

Note: The measurements should be within specifications and the correct bearings should be used. If the crankshaft journals and the bores for the block and the rods were measured during disassembly, no further checks are necessary. However, if the technician still wants to measure the

bearing clearances, Tooling (A) is an acceptable method. Tooling (A) is less accurate on journals with small diameters if clearances are less than 0.10 mm (0.004 inch).

NOTICE

Lead wire, shim stock or a dial bore gauge can damage the bearing surfaces.

The technician must be very careful to use Tooling (A) correctly. The following points must be remembered:

- Ensure that the backs of the bearings and the bores are clean and dry.
- Ensure that the bearing locking tabs are properly seated in the tab grooves.
- The crankshaft must be free of oil at the contact points of Tooling (A).

1. Put a piece of Tooling (A) on the crown of the bearing that is in the cap.

Note: Do not allow Tooling (A) to extend over the edge of the bearing.

2. Use the correct torque-turn specifications in order to install the bearing cap. Do not use an impact wrench. Be careful not to dislodge the bearing when the cap is installed.

Note: Do not turn the crankshaft when Tooling (A) is installed.

3. Carefully remove the cap, but do not remove Tooling (A). Measure the width of Tooling (A) while Tooling (A) is in the bearing cap or on the crankshaft journal. Refer to Illustration 1.



Illustration 1

g00473227

Typical Example

4. Remove all of Tooling (A) before you install the bearing cap.

Note: When Tooling (A) is used, the readings can sometimes be unclear. For example, all parts of Tooling (A) are not the same width. Measure the major width in order to ensure that

Thank you so much for reading.
Please click the “Buy Now!”
button below to download the
complete manual.



After you pay.

You can download the most
perfect and complete manual in
the world immediately.

Our support email:

ebooklibonline@outlook.com