

Product: WHEEL LOADER

Model: 930R WHEEL LOADER 17B

Configuration: 930T WHEEL LOADER 17B01000-02010 (MACHINE) POWERED BY 3304 ENGINE

## Disassembly and Assembly 3304B and 3306B Engines for Caterpillar Built Machines

Media Number -SEN5598-09

Publication Date -01/01/2013

Date Updated -25/01/2013

i01138035

# Fuel Injection Pump Housing - Assemble

SMCS - 1253-016

## Assembly Procedure

Table 1

Required Tools			
Tool	Part Number	Part Description	Qty
A	1P-1860	Retaining Ring Pliers	1
B	1P-0510	Driver Group	1
C	6V-2016	Plate	1
	0S-1594	Bolt	2
	6V-4818	Driver	1

---

### NOTICE

**Keep all parts clean from contaminants.**

**Contaminants may cause rapid wear and shortened component life.**

---

**Note:** Put clean engine oil on all parts before assembly. Ensure that all of the oil passages are clear.

---

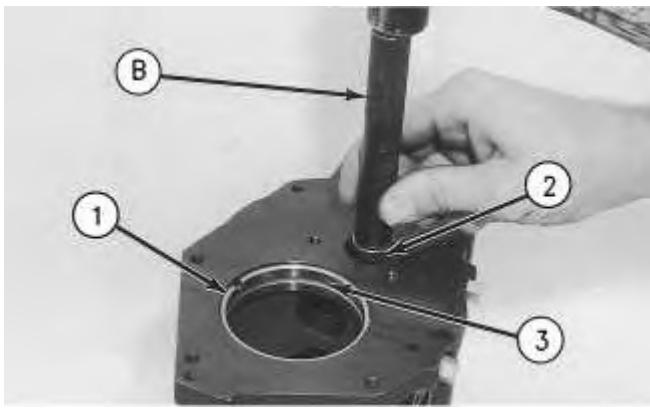

Illustration 1

g00457491

1. Use Tool (B) in order to install large bearing (1) in the governor end of the fuel injection pump housing. Bearing joint (3) should be facing toward the top of the fuel injection pump housing. Install the bearing so the bearing is  $0.25 \pm 0.20$  mm ( $.010 \pm .008$  inch) below the surface of the fuel injection pump housing.
2. Use Tool (B) in order to install small bearing (2) in the governor end of the fuel injection pump so that Tool (B) is  $7.16 \pm 0.13$  mm ( $.282 \pm .005$  inch) below the surface of the fuel injection pump housing.



Illustration 2

g00457492

3. Use Tool (B) in order to install large bearing (4) in the drive end of the fuel injection pump housing. The bearing joint should be facing toward the top of the fuel injection pump housing. Install the bearing so the bearing is  $1.00 \pm 0.25$  mm ( $.039 \pm .010$  inch) below the surface of the fuel injection pump housing.

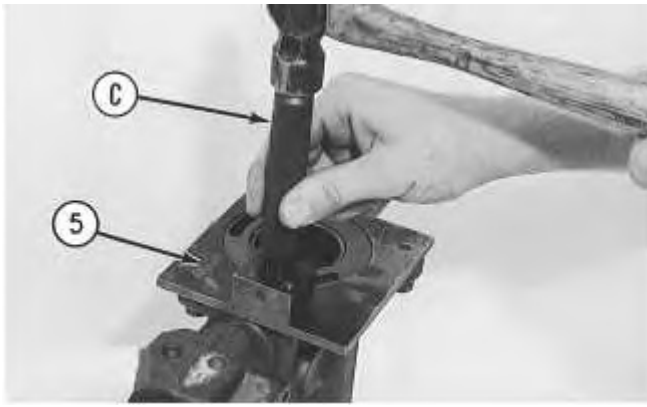

Illustration 3

g00457493

4. Install the plate of Tool (C) on the drive end of the fuel injection pump in order to install small bearing (5) for the rack. Use clean grease in order to hold the new driver for the rack bearing of Tool (C). Install the driver and the bearing in the plate. Ensure that the groove in the driver is aligned with the pin in the plate and use a hammer to push the bearing into position. The bearing will be installed to the correct depth when the shoulder of the driver is against the plate.
5. Remove Tool (C) from the fuel injection pump housing. The fuel rack bearing must be installed so that the fuel rack bearing is  $0.25 \pm 0.25$  mm ( $.010 \pm .010$  inch) below the surface of the housing.

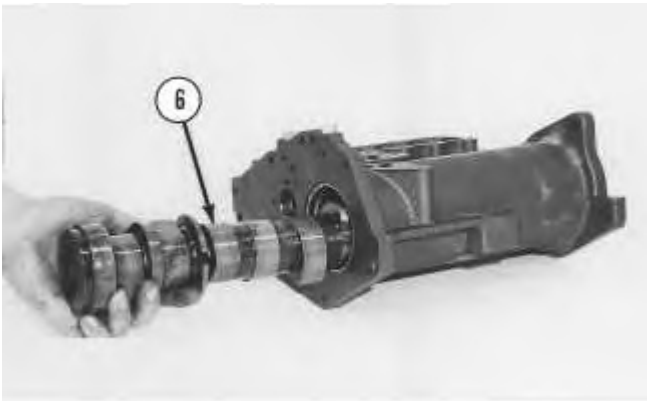

Illustration 4

g00457494

6. Install camshaft (6) .

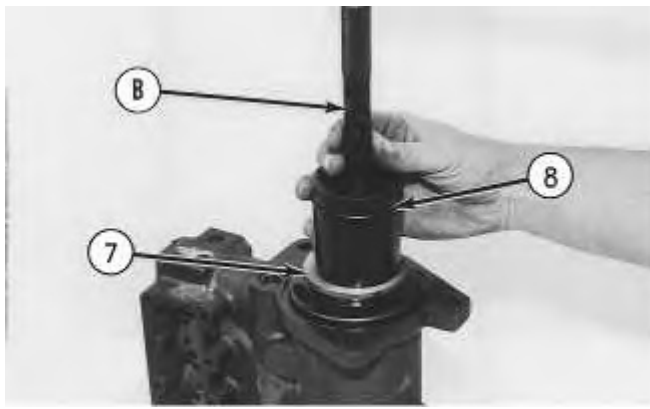

Illustration 5

g00458729

7. Put the fuel injection pump housing upright, as shown. Place a wood block under the camshaft.
8. Put washer (7) over the end of the camshaft. Use Tool (B) and spacer (8) in order to push the washer against the seat on the camshaft. Spacer (8) has an inside diameter of 38.1 mm (1.50 inch) and a length of 31.75 mm (1.250 inch). The camshaft must have an end play of  $0.18 \pm 0.08$  mm ( $.007 \pm .003$  inch) when the washer is pushed against the shoulder of the camshaft.

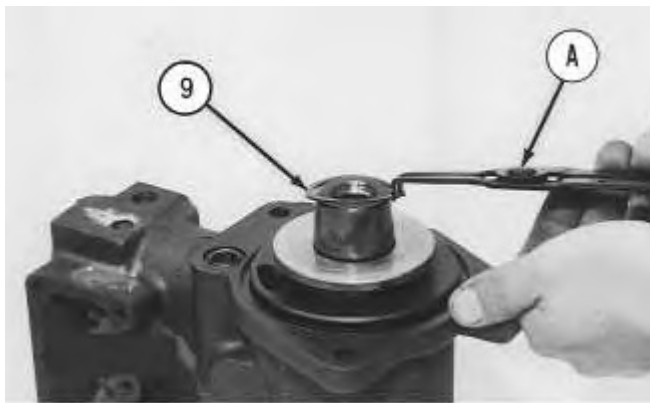
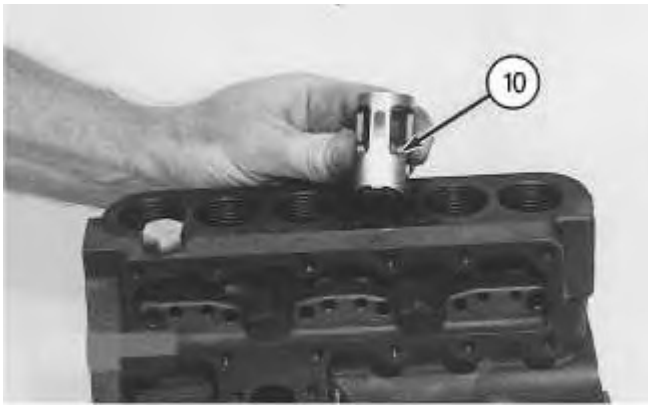

Illustration 6

g00457495

9. Use Tool (A) in order to install snap ring (9) .



---

Illustration 7

g00458730

**Note:** Check the condition of the new lifters. Replace the lifters, if necessary. If the original lifters are being reused, place the lifters in the original locations. New lifters are identical, and the new lifters can be placed in any order.

10. Install six lifters (10) in the fuel injection pump housing. Ensure that the groove in the lifter is aligned with the pin in the fuel injection pump housing.

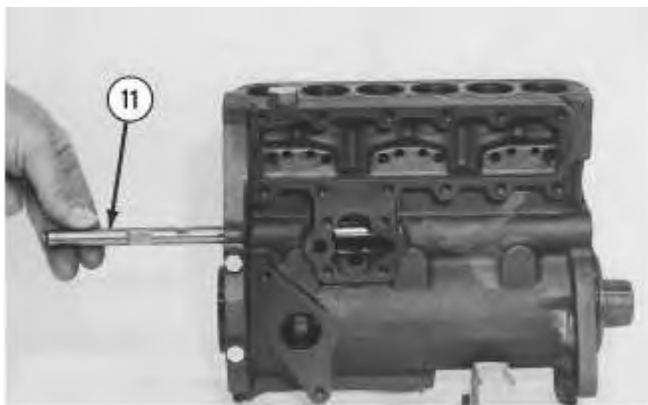

---

Illustration 8

g00458731

11. Install rack (11). Ensure that the groove in the end of the rack is aligned with the ear (tab) of the fuel rack bearing that is at the drive end of the fuel injection pump housing.
-



---

Illustration 9

g00458732

12. Install the gasket and cover (12) .

**End By:**

- a. Assemble the governor. Refer to Disassembly and Assembly, "Governor - Assemble".
  - b. Install the fuel injection pumps. Refer to Disassembly and Assembly, "Fuel Injection Pump - Install".
-

Product: WHEEL LOADER

Model: 930R WHEEL LOADER 17B

Configuration: 930T WHEEL LOADER 17B01000-02010 (MACHINE) POWERED BY 3304 ENGINE

## Disassembly and Assembly 3304B and 3306B Engines for Caterpillar Built Machines

Media Number -SEN5598-09

Publication Date -01/01/2013

Date Updated -25/01/2013

i01111133

# Fuel Injection Pump Housing and Governor - Install

SMCS - 1286-012

## Installation Procedure

Table 1

Required Tools			
Tool	Part Number	Part Description	Qty
A	5P-7307	Engine Turning Tool	1
B	4C-9874	Spanner Wrench	1
C	6V-4186	Fuel Pump Timing Pin	2

---

### NOTICE

**Keep all parts clean from contaminants.**

**Contaminants may cause rapid wear and shortened component life.**

---

**Note:** The No. 1 piston must be set at the top center position (TC) in order to perform all of the timing procedures.

**Note:** The engine is seen from the flywheel end when the direction of the crankshaft rotation is given.

---

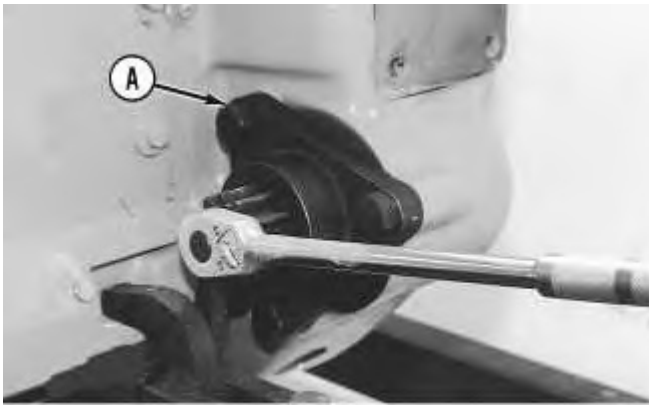

Illustration 1

g00460164

1. Remove the electric starting motor.
2. Install Tool (A) into the flywheel housing, as shown.
3. To find the TC position for the No. 1 piston, perform the following procedure:
  - a. Turn the flywheel clockwise or turn the flywheel in the opposite direction of the engine rotation for approximately 30 degrees. This removes all play from the timing gears.

**Note:** If you go past the bolt hole, repeat Step 3.a.

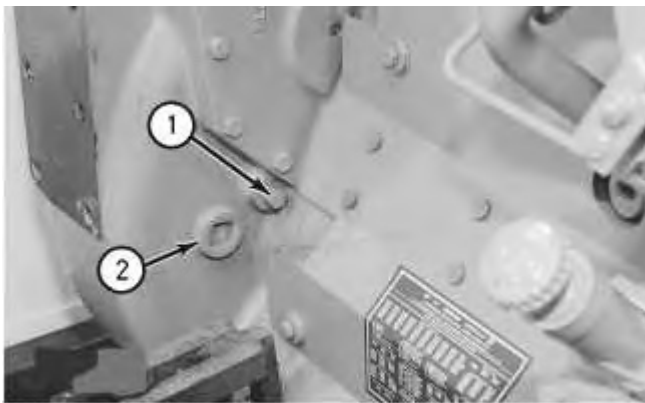

Illustration 2

g00460248

- b. Remove plugs (1) and (2) .



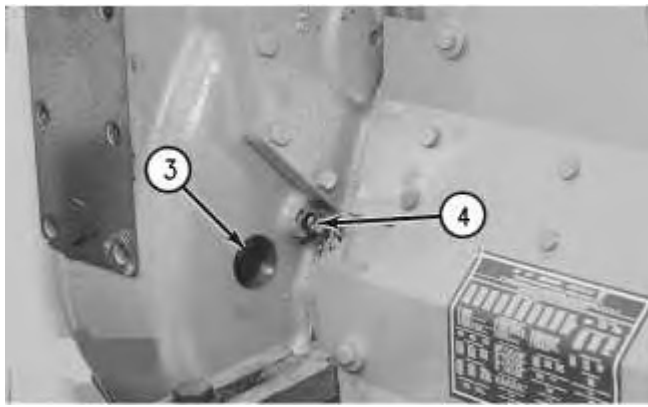

Illustration 3

g00460252

- c. Turn the flywheel counterclockwise until a 3/8-16 X 3 1/2 NC bolt (4) can be installed in the flywheel through the hole in the flywheel housing. The No. 1 and No. 6 pistons are now at the TC position. Plug (2) was removed for viewing through inspection hole (3) .

**Note:** The No. 1 piston is on the compression stroke when the valves of the No. 1 cylinder are closed. The rocker arms for the inlet valves and for the exhaust valves must have slight side-to-side movement.

- d. In order to check the position of the inlet and exhaust valves, remove the valve mechanism cover. Refer to Disassembly and Assembly, "Valve Mechanism Cover - Remove and Install".
4. If the No. 1 piston is not on the compression stroke, remove bolt (4) and turn the flywheel for 360 degrees counterclockwise. Install bolt (4). The No. 1 piston is now at the TC position.

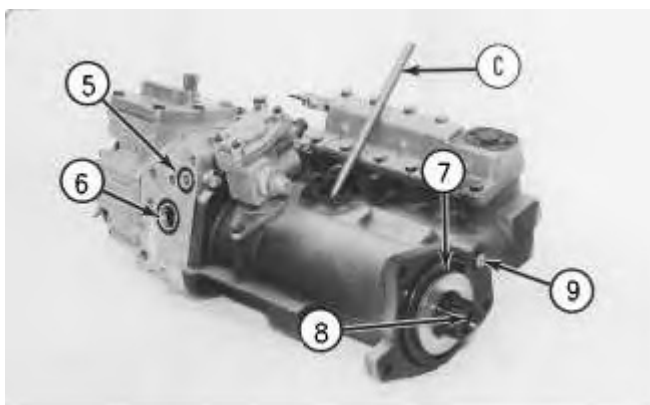

Illustration 4

g00460258

Typical example

5. Install Tool (C) in the fuel injection pump housing, as shown. Push on Tool (C) and turn fuel injection pump camshaft (8). When Tool (C) engages the groove (slot) in the camshaft, the fuel injection pump is in the TC position for the No. 1 piston.

**Note:** Check the condition of the O-ring seals. Replace the O-ring seals, if necessary.

6. Ensure that O-ring seals (5), (6), (7) and (9) are in position on the fuel injection pump housing and the governor. Put clean engine oil on the seals.

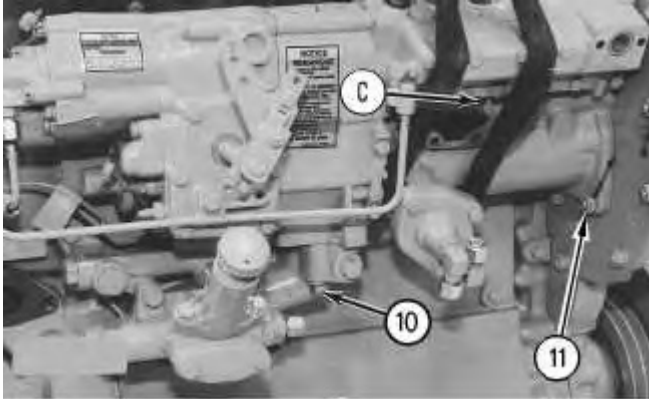

Illustration 5

g00460259

7. Attach a hoist and put the fuel injection pump housing and the governor in position on the timing gear plate and the oil manifold. Install three nuts (11), two bolts (10) and the washers. Ensure that Tool (C) remains in place.

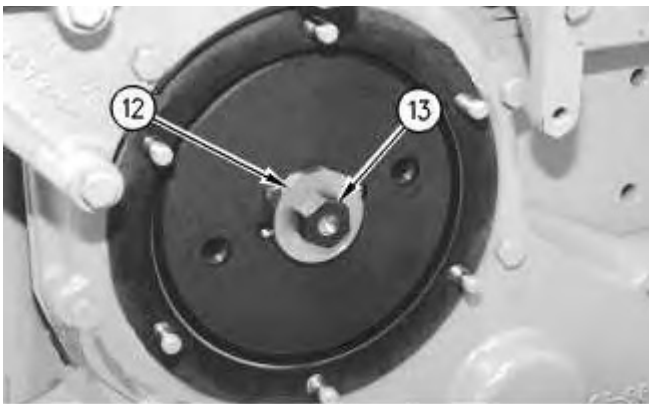

Illustration 6

g00460341

8. Install washer (12) with the large side outward. Install bolt (13) finger tight. Ensure that Tool (C) is in the notch in the camshaft of the fuel injection pump.
-

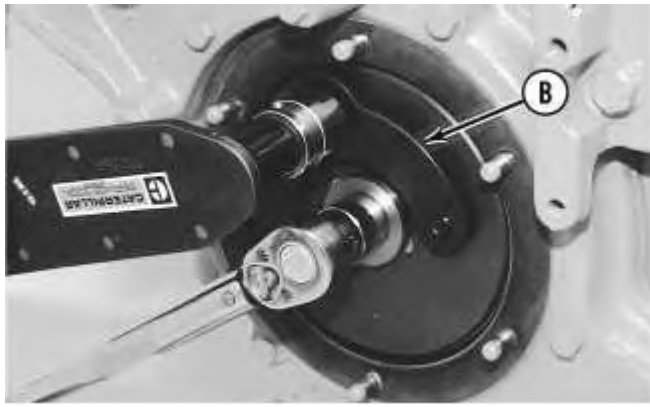

Illustration 7

g00460342

9. Install Tool (B) on the fuel pump drive gear. Apply 68 N·m (50 lb ft) of force to the fuel pump drive gear with timing bolt (3) in position in the flywheel and Tool (C) in position in the fuel system. Apply this force in a clockwise direction when the engine is viewed from the front. Use Tool (B) and a suitable torque wrench. Hold the 68 N·m (50 lb ft) of force on Tool (B) and torque the drive gear bolt to a torque of  $270 \pm 25$  N·m ( $200 \pm 18$  lb ft). Remove Tool (B) and Tool (C) from the fuel pump and remove bolt (3) from the flywheel.
10. Use Tool (A) and turn the flywheel for two complete revolutions. When bolt (3) goes in the hole in the flywheel and Tool (C) is installed in the notch in the camshaft, the timing is correct.
11. Install plugs (1) and (2) .
12. Remove Tool (A). Install the electric starting motor.
13. Install the valve mechanism cover. Refer to Disassembly and Assembly, "Valve Mechanism Cover - Remove and Install".

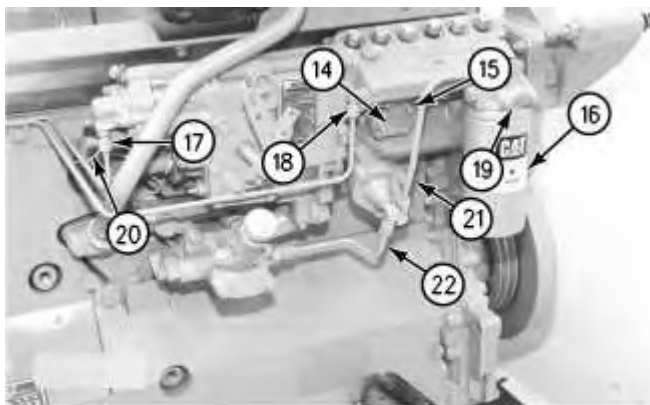

Illustration 8

g00460343

14. Put cover (14) and the gasket in position. Install four bolts (15) .
15. Put the fuel filter base, the gasket, and fuel filter (16) in position. Install two bolts (19) and the washers.

16. Install tube assemblies (21) and (22). Connect wire (20). Connect hoses (17) and (18) .

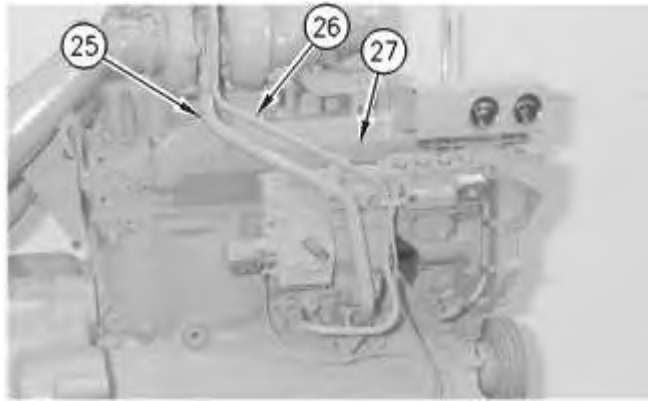

Illustration 9

g00589938

17. On the 3304B engines, install the strainer assembly in the turbocharger with the screen downward. Install the gasket, the oil inlet line and the bolts. Install the O-ring seal on oil drain line (25). Apply clean engine oil to the O-ring seal and install the gasket. Connect oil drain line (25) and install the bolts. Install the clamps on the oil line.



Illustration 10

g00460346

18. Put cover (24) in position. Install nuts (23) and six washers. Tighten nuts (23) to a torque of  $27 \pm 7 \text{ N}\cdot\text{m}$  ( $20 \pm 5 \text{ lb ft}$ ).

**End By:** Install the fuel injection lines. Refer to Disassembly and Assembly, "Fuel Injection Lines - Remove and Install".

---

Product: WHEEL LOADER

Model: 930R WHEEL LOADER 17B

Configuration: 930T WHEEL LOADER 17B01000-02010 (MACHINE) POWERED BY 3304 ENGINE

## Disassembly and Assembly 3304B and 3306B Engines for Caterpillar Built Machines

Media Number -SEN5598-09

Publication Date -01/01/2013

Date Updated -25/01/2013

i00886792

### Governor - Disassemble

SMCS - 1264-015

### Disassembly Procedure

Table 1

Required Tools			
Tool	Part Number	Part Description	Qty
A	1P-0510	Driver Group	1
B	6V-2163	Spring Clamp	1
C	1P-1855	Retaining Ring Pliers	1

#### Start By:

- A. Remove the fuel injection pump housing and the governor. Refer to Disassembly and Assembly, "Fuel Injection Pump Housing and Governor - Remove".

**Note:** To remove the governor for the disassembly of the fuel injection pump housing, perform Steps 1, 2, 16, 22, 24, 25, 26, 27, 30, 32 and 34.

---

#### NOTICE

**Keep all parts clean from contaminants.**

**Contaminants may cause rapid wear and shortened component life.**

---

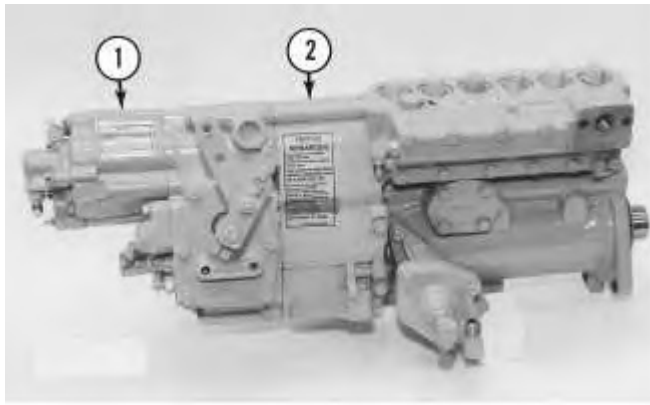

Illustration 1

g00453006

1. Remove fuel ratio control (1) from governor (2) .

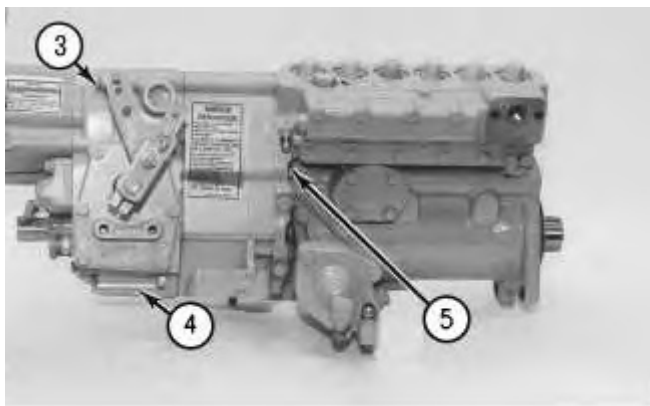

Illustration 2

g00453007

**Note:** Illustration 2 shows the fuel ratio control that is still connected.

2. Remove six bolts (3), two bolts (5), housing (4) and the gasket.

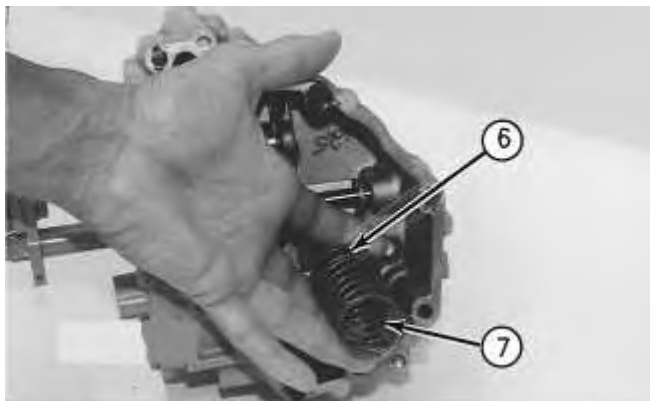

Illustration 3

g00453008

3. Remove governor spring (7), seat (6) and the washers.

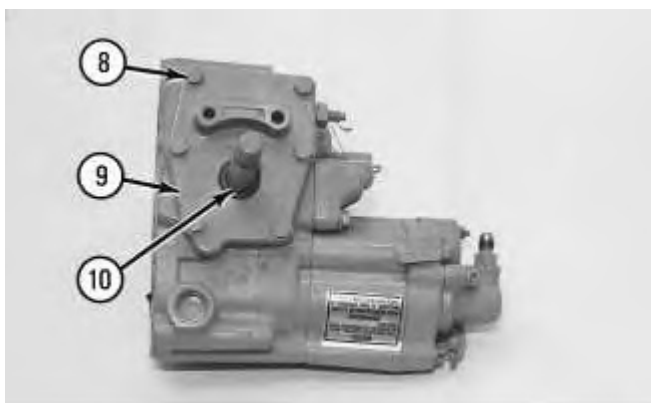

Illustration 4

g00453009

4. Remove six bolts (8), cover (9) and the gasket. Use Tool (A) in order to remove seal (10) .

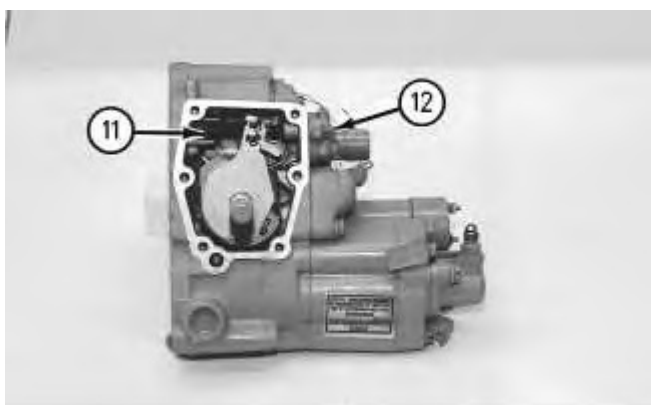
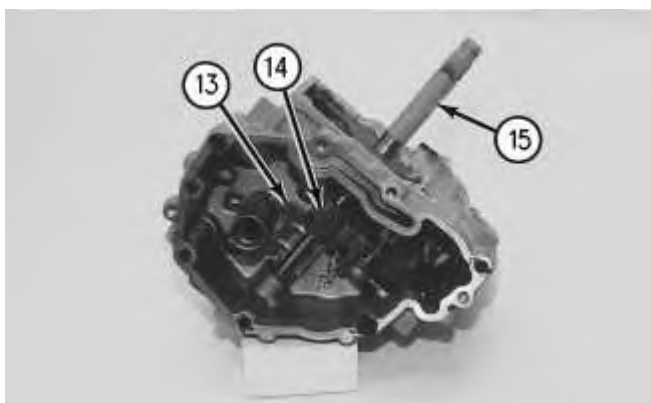

Illustration 5

g00453010

5. Remove low idle adjustment screw (12) and spring (11) .



6. Remove shaft assembly (15) and levers (14) and (13) .

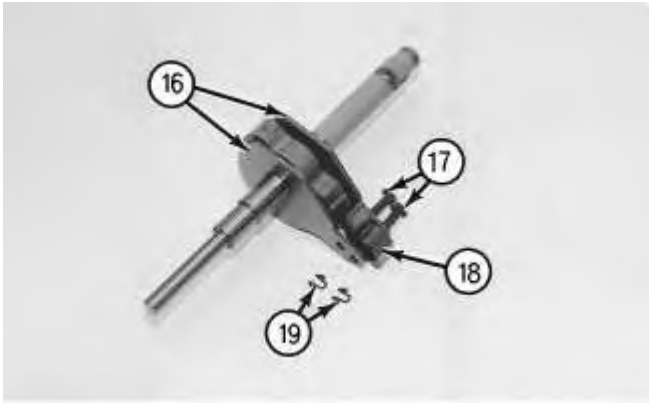

---

Illustration 7

7. Remove two snap rings (19) from two pins (17). Remove two pins (17). Remove plates (16) and stop (18) .

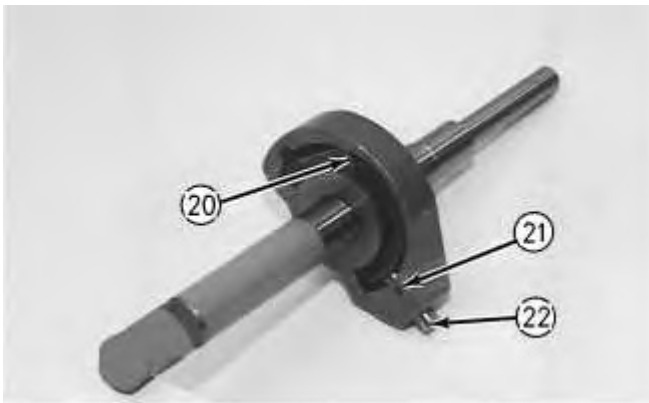

---

Illustration 8

8. Remove pins (21) and (22) and remove spring (20) .
-



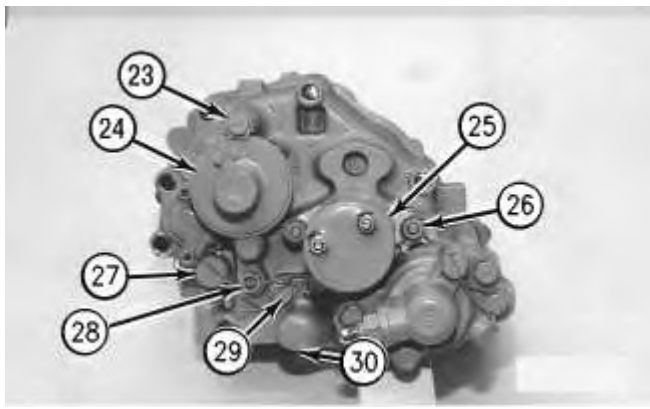

---

Illustration 9

g00453015

9. Remove two bolts (23), and the washers, and remove adapter (24), the coupling, and the O-ring seal.
10. Remove contact (27) and body (28) with an O-ring seal.
11. Remove two bolts (29) and the washers and remove cover (30) and the gasket.
12. Remove two nuts and washers (26) and remove shutoff solenoid (25) and the gasket.

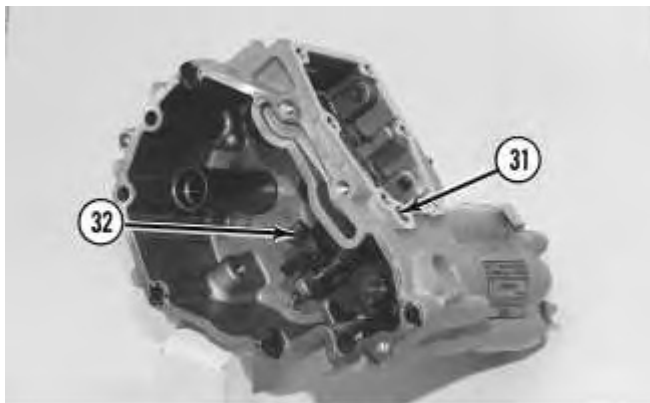

---

Illustration 10

g00453016

13. Remove shaft (31) and lever (32) .
-

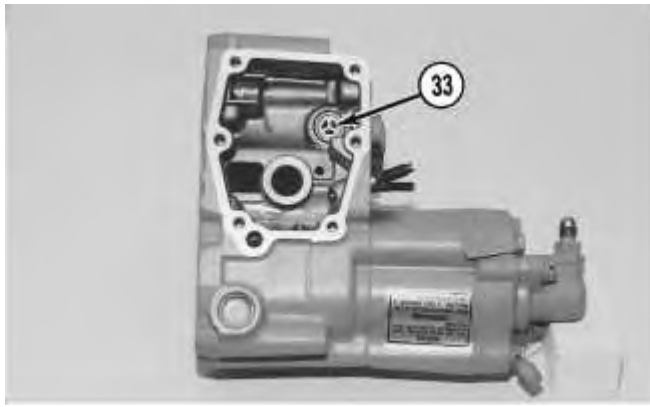

Illustration 11

g00453017

**Note:** The check valve will be damaged during removal. Remove check valve (33) only if a replacement is necessary.

14. Remove check valve (33) only if a replacement is necessary.

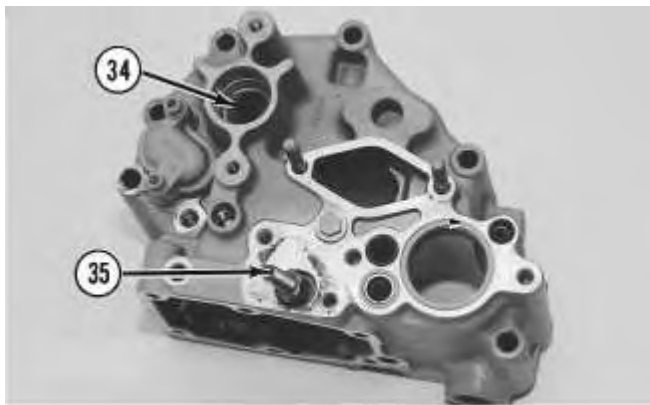
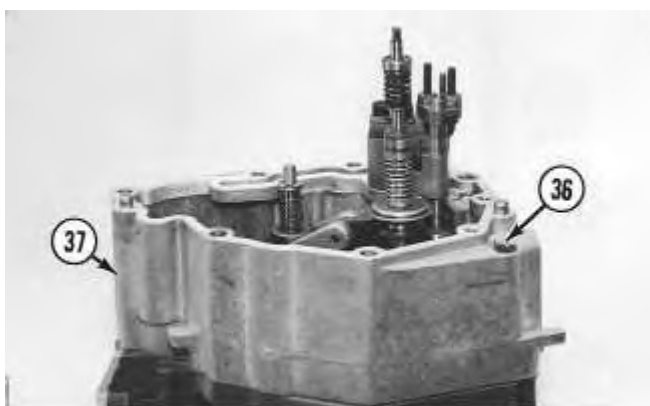

Illustration 12

g00453018

15. Remove seal (34) and adjustment screw (35) .



16. Remove bolt (36), housing (37) and the gasket from the fuel injection pump housing.

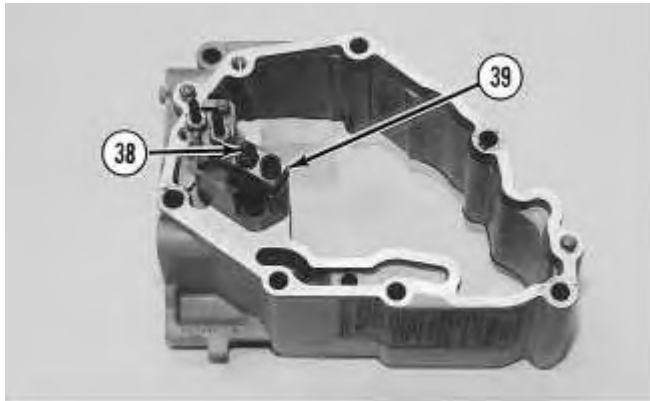

Illustration 14

g00453557

Typical example

17. Remove bolts (38) and remove torque control (39) .
18. Disassemble torque control (39) and inspect the spacer, the spring, and the insulator for damage or wear. Replace parts that are worn or damaged with new parts.

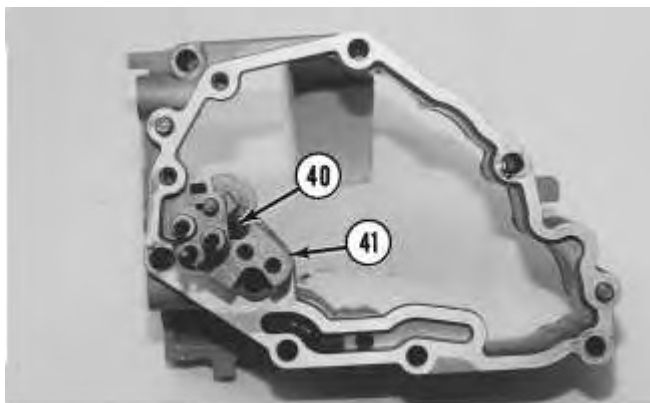

Illustration 15

g00453558

19. Remove two bolts (40) and block (41) .
-

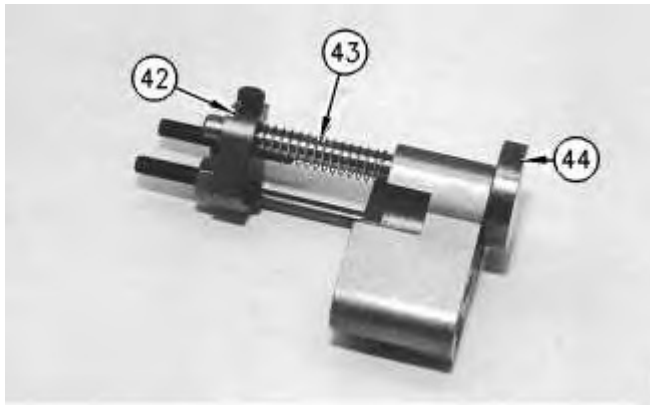

Illustration 16

g00453559

20. Remove the bolt that holds collar (42) to bolt (44). Remove collar (42), spring (43) and bolt (44) .
21. Remove the stop screws from collar (42) if the collar needs to be replaced.

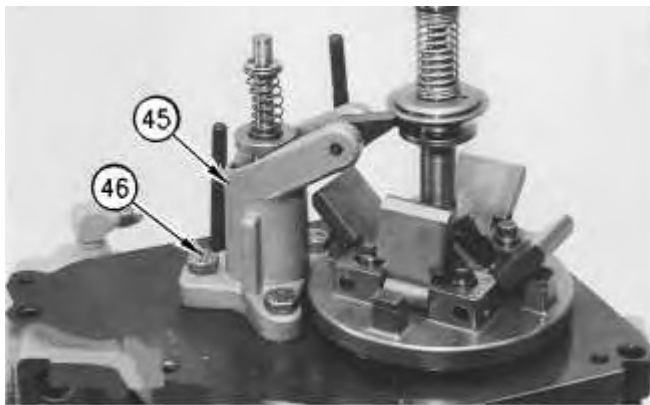
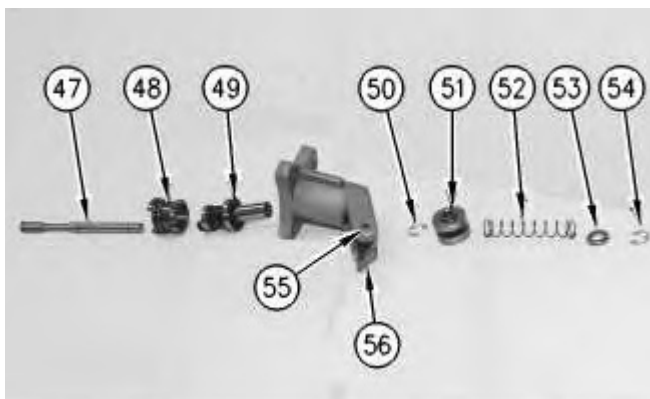

Illustration 17

g00453560

22. Remove three bolts (46) and remove governor servo (45). The governor servo must be rotated in order to be released from the rack's regulator.



Thank you so much for reading.  
Please click the “Buy Now!”  
button below to download the  
complete manual.



After you pay.

You can download the most  
perfect and complete manual in  
the world immediately.

Our support email:

[ebooklibonline@outlook.com](mailto:ebooklibonline@outlook.com)