

Product: TRACK LOADER

Model: 941 TRACK LOADER 80H

Configuration: 941B TRAXCAVATOR 80H05703-UP (MACHINE) POWERED BY 3304 ENGINE

## Disassembly and Assembly

### SLEEVE METERING FUEL SYSTEM FOR FOUR AND SIX CYLINDER 4.75"

Media Number -REG01400-01

Publication Date -01/03/1974

Date Updated -17/03/2010

REG01400004

## Adapter Housings And Levers

SMCS - 1278-11; 1278-12; 1278-15; 1278-16

### Remove Adapter Housings And Levers (If So Equipped)

start by:

- a) remove fuel ratio control
- b) remove fuel shutoff solenoid

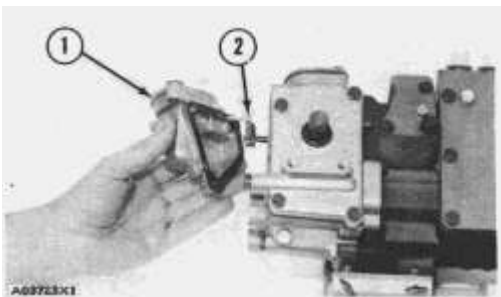

1. Remove adapter housing (1) from governor housing.

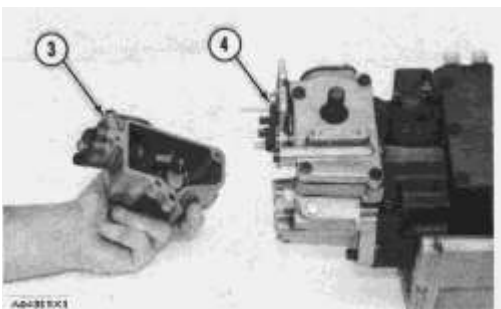

**NOTE:** There are two different adapter housings used with the fuel system. Adapter housing (1) is used when only a fuel ratio control is needed. Adapter housing (3) is used when a combination of fuel ratio control, fuel shutoff solenoid and oil pressure safety shutoff is needed.

2. Remove control lever (2) or (4) from shaft.

**NOTE:** There is a different control lever for each adapter housing. On a truck fuel system, there is a spring between the lever and governor housing.

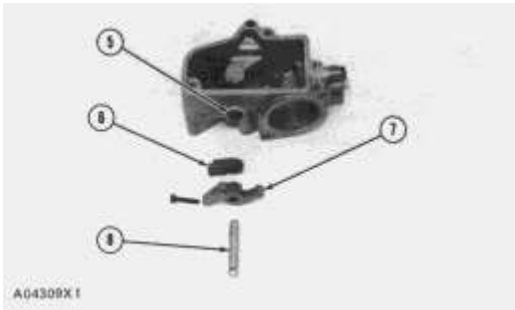

3. Remove shaft (8), lever assembly (7) and lever (6) from adapter housing.

4. Remove seal (5) from adapter housing.

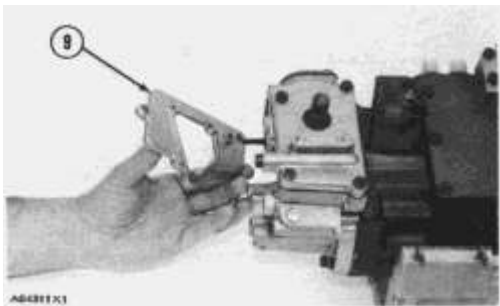

5. Remove base (9) from governor housing.

## **Install Adapter Housings And Levers (If So Equipped)**

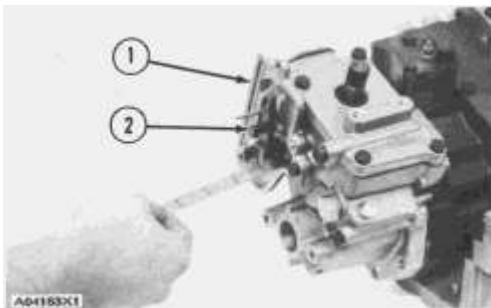

1. Install base (1) on governor housing.

2. Install control lever (2) on shaft which is for adapter housing (5).

3. Check the distance between the governor housing and inside of lever (2). This distance must be  $.438 \pm .010$  in. ( $11.13 \pm 0.25$  mm) with the shaft pulled out tight against the governor housing.

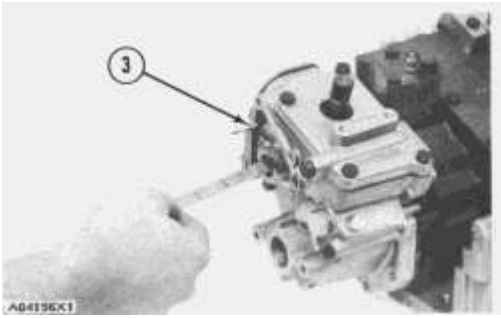

4. Install control lever (3) which is for the adapter housing that has fuel ratio control only.
5. Check the distance between the inside of lever (3) and governor housing. This distance must be  $.590 \pm .010$  in. ( $14.99 \pm 0.25$  mm) with the shaft pulled out tight against the inside of the governor housing.

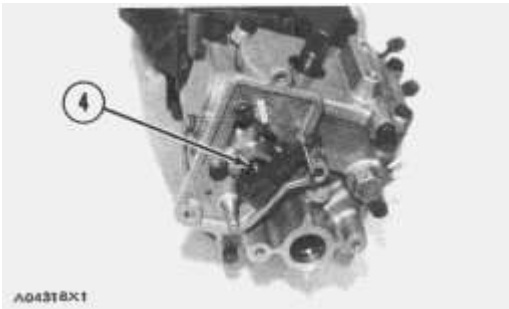

**NOTE:** On a truck fuel system, there is a spring (4) between the lever and governor housing. This spring must be turned (wound) 1 1/4 turns clockwise to get a preload when installed.

6. Install seal in adapter housing.
7. Install lever, lever assembly and shaft.

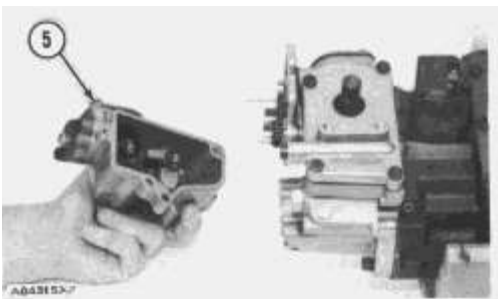

8. Install adapter housing (5) on base.

end by:

- a) install fuel shutoff solenoid
  - b) install fuel ratio control
-

Product: TRACK LOADER

Model: 941 TRACK LOADER 80H

Configuration: 941B TRAXCAVATOR 80H05703-UP (MACHINE) POWERED BY 3304 ENGINE

## Disassembly and Assembly SLEEVE METERING FUEL SYSTEM FOR FOUR AND SIX CYLINDER 4.75"

Media Number -REG01400-01

Publication Date -01/03/1974

Date Updated -17/03/2010

REG01400005

### Speed Limiter

SMCS - 1268-11; 1268-12

Sleeve Metering Fuel System With Speed Limiter (Earlier Fuel Systems)

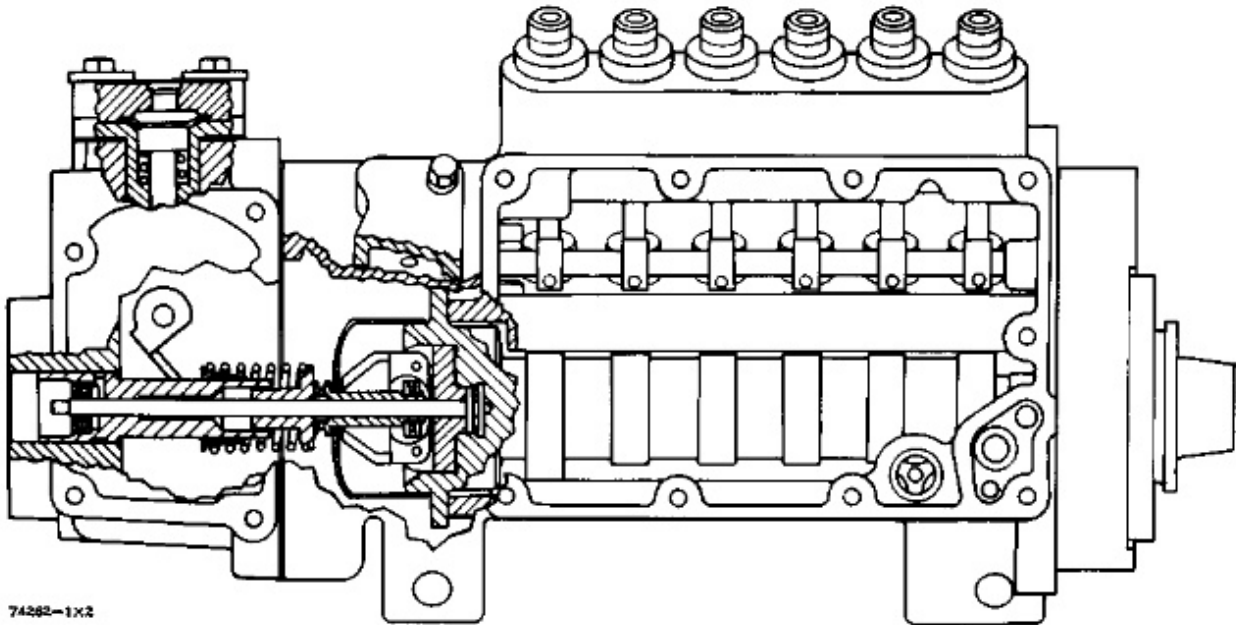

Remove Speed Limiter (Earlier Fuel Systems)



1. Remove the bolts (1) and washers that hold the cover (2) to governor housing. Remove the cover (2).
2. Remove the diaphragm from governor housing.



3. Remove the plunger (4) and spring (3) from governor housing.
4. Remove the body (5) from the governor housing.

## **Install Speed Limiter (Earlier Fuel Systems)**

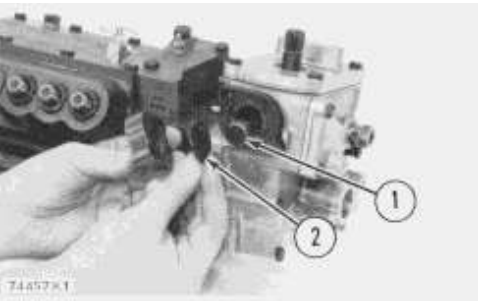

1. Install the body, spring, and plunger (1).
2. Install the diaphragm (2) and cover.



3. Install the bolts (3) and washers.
  4. See ADJUSTMENT of SPEED LIMITER in TESTING AND ADJUSTING.
-

Product: TRACK LOADER

Model: 941 TRACK LOADER 80H

Configuration: 941B TRAXCAVATOR 80H05703-UP (MACHINE) POWERED BY 3304 ENGINE

## Disassembly and Assembly

### SLEEVE METERING FUEL SYSTEM FOR FOUR AND SIX CYLINDER 4.75"

Media Number -REG01400-01

Publication Date -01/03/1974

Date Updated -17/03/2010

REG01400006

## Fuel Injection Pump Housing And Governor

SMCS - 1268-11; 1268-12

### Separation Of Governor From Fuel Injection Pump Housing

Tools Needed		A	B
2P8315	Bracket Assembly	1	
5P302	Bar		1

1. Put the fuel injection pump housing on tool (A).

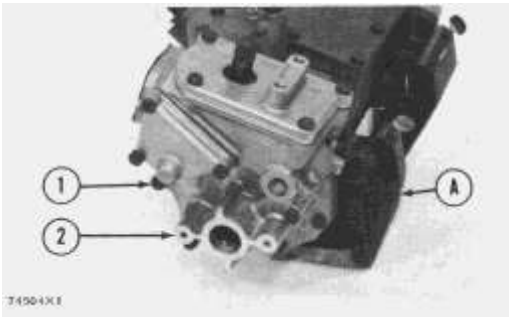

2. Remove bolts (1) that hold the governor housing (2) to the fuel injection pump housing.

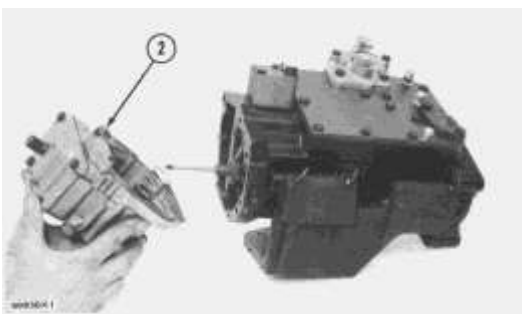

3. Remove governor housing (2) from pump housing.

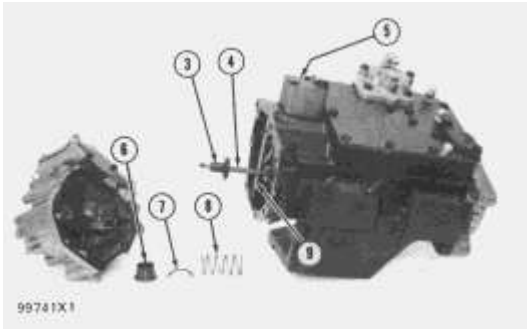

4. Remove cover (5) over the torque spring.

5. Remove spring (8), (wave) washer (7) and guide (6) from governor housing.

6. Remove seat (3) and over fueling spring (4).

7. Pull shaft (9) up and remove shaft and lever from the housing.

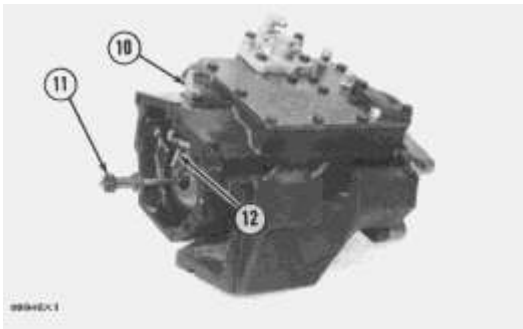

8. Remove torque spring assembly (10) and pin.

**NOTE:** Some fuel systems do not have a torque spring. They have only a stop.

9. Remove riser (follower) (11) from the shaft.

10. Remove ring and lever (12) from the dowel.

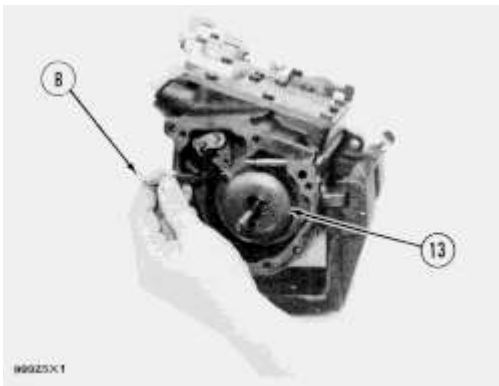

11. Remove cover (13) for the flyweights with tool (B).

**NOTE:** Tool (B) can cause damage to the cover. Always inspect cover and install a new cover if needed.

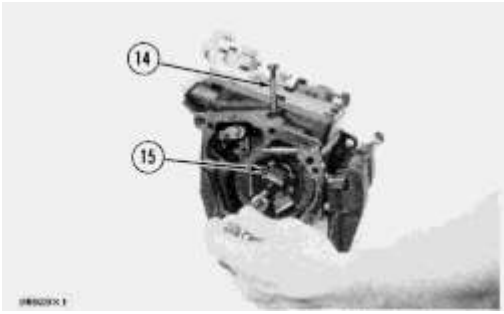

12. Install timing pin (14) to hold the camshaft from turning.
13. Remove bolts (15) that hold flyweight assembly to camshaft.

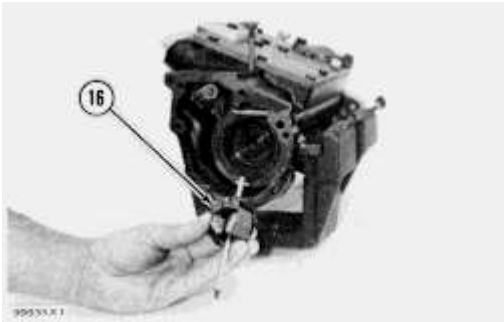

14. Remove the flyweight assembly (16) from the fuel injection pump housing.
15. Remove the timing pin from the housing.

## Connection Of Governor To Fuel Injection Pump Housing

Tools Needed		A	B
2P8315	Bracket Assembly	1	
5P301	Driver		1

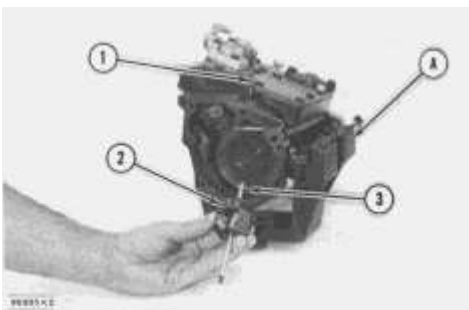

1. Put the fuel injection pump housing on tool (A).
  2. Install timing pin (1) to keep the camshaft from turning.
  3. Put flyweight assembly (2) in position on the camshaft.
-



## NOTICE

**Be sure pin (3) that holds shaft is in the correct position on back of the flyweight assembly.**

---

4. Install new bolts for the flyweight assembly.

**NOTE:** The bolts for the flyweight assembly have a locking material on the threads and must not be used more than one time.



5. Install cover over the flyweight assembly with tool (B).

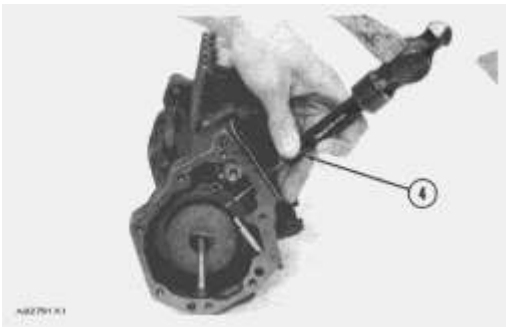

6. Grind a taper on the bottom edge of a 1/8" screwdriver (4). Install the screwdriver through the bolt hole in the governor housing. The screwdriver must fit evenly against the flyweight assembly cover. Make a mark (stake) in four places around the cover in line with the groove in the camshaft.

---

## NOTICE

**Never install a used flyweight cover that is bent.**

---

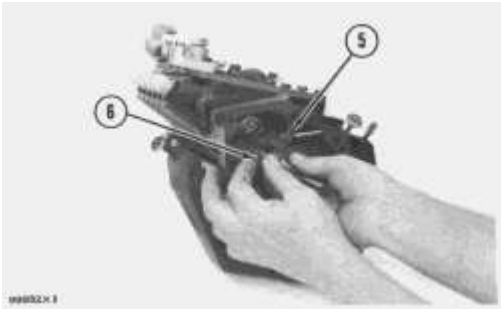

7. Install lever (5) on the dowel. Install ring (6) that holds lever on dowel.

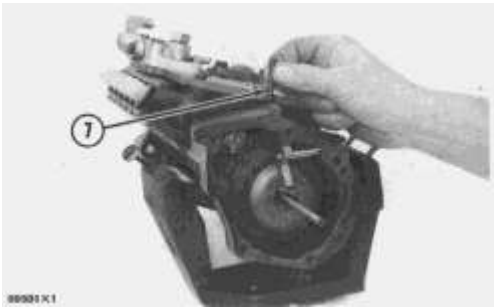

8. Install pin (7) in the housing with the round end down.

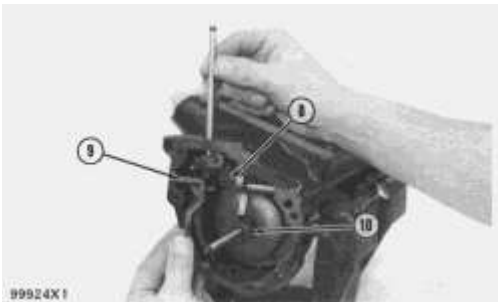

9. Put riser (follower) (10) in position between the flyweights. Lift the flyweight up with a piece of wire and push riser (follower) forward.

10. Put lever (9) into position in groove of riser (follower) (10) and ball end engaged in the sleeve shaft lever (8). Install shaft to hold lever in place.

---

## NOTICE

**If lever (9) is not installed correctly, the governor cannot operate and can cause the engine to over speed.**

---

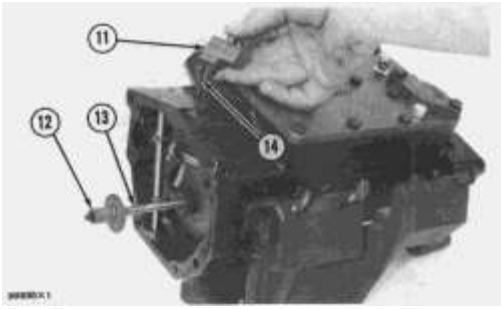

11. Install over fueling spring (13) and seat (12) on shaft.
12. Install stud (14) and torque spring or stop bar (11) on the housing.

---

### NOTICE

**The screw that holds the torque spring must not go beyond the inner surface of the governor housing.**

---

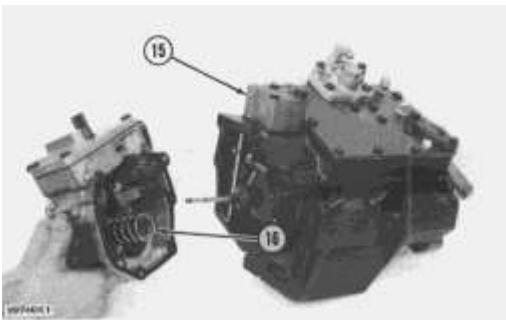

13. Install cover (15) over torque spring after adjustment has been made.
14. Install guide, (wave) washer and spring (16) in the governor housing.
15. Put the governor housing on the fuel injection pump housing and install the bolts.

end by:

- a) make adjustment of fuel system setting (See Fuel System Setting in Testing and Adjusting)
-

Product: TRACK LOADER

Model: 941 TRACK LOADER 80H

Configuration: 941B TRAXCAVATOR 80H05703-UP (MACHINE) POWERED BY 3304 ENGINE

## Disassembly and Assembly SLEEVE METERING FUEL SYSTEM FOR FOUR AND SIX CYLINDER 4.75"

Media Number -REG01400-01

Publication Date -01/03/1974

Date Updated -17/03/2010

REG01400007

### Governor

SMCS - 1264-15; 1264-16

### Disassemble Governor

start by:

a) separation of governor from fuel injection pump housing

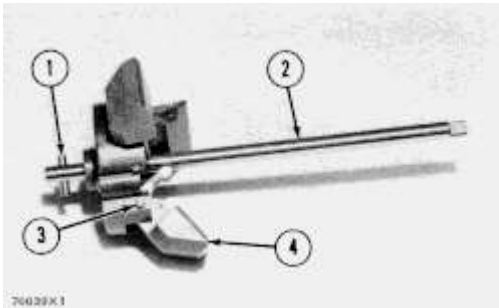

1. Remove shaft (2). Remove pin (1) from shaft.
2. Remove pins (3) from the flyweights. Remove flyweights (4).

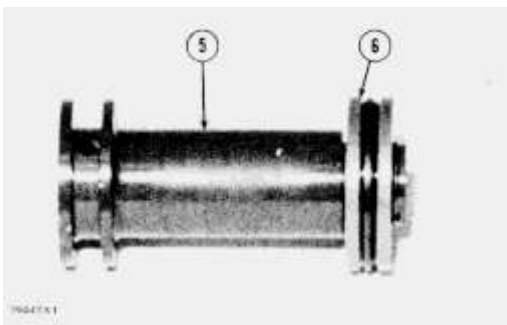

3. Remove ring, races (6) and bearing from the riser (follower) (5).

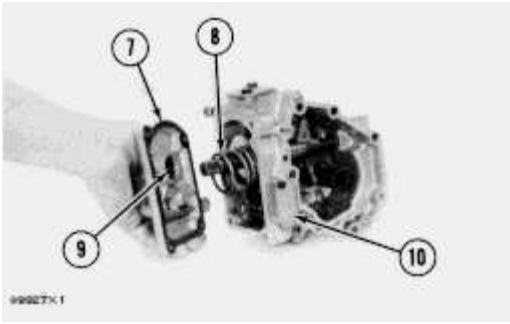

4. Remove cover (7) and spring (8) from governor housing.

**NOTE:** There is force on the cover from the spring.

5. Remove seal (9) from cover.

6. Remove cover (10) for the low and high idle adjustment.

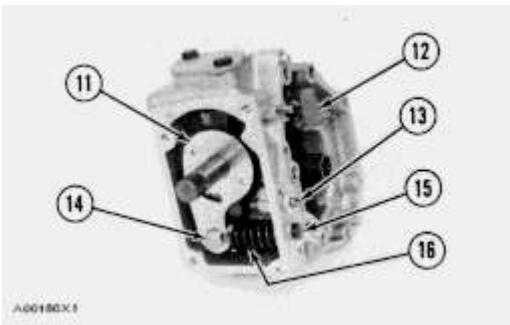

7. Remove locknut and screw (13) for the high idle adjustment.

8. Remove bolt (15) and washers for the low idle adjustment.

9. Remove spring (16) and guide.

10. Remove pin (14) and plate (11).

11. Remove shaft (12) from the housing.

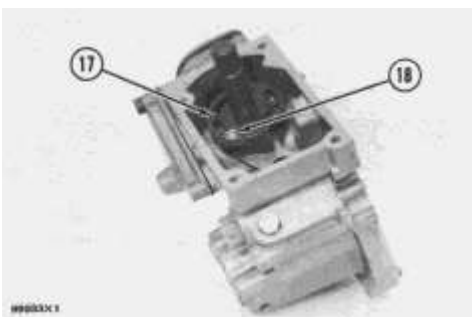

12. Remove pin (18) and two spacers (17) from shaft.

**NOTE:** Earlier fuel systems have a ball in place of spacers (17) and pin (18).

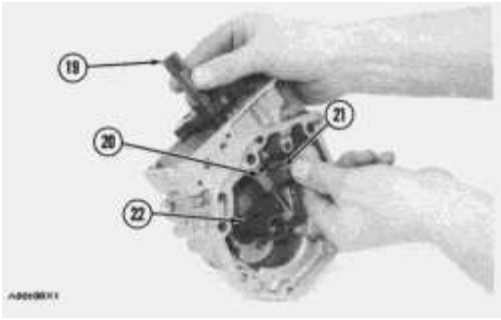

13. Remove shaft (19) from the governor housing.

14. Remove washer (20) and levers (21) and (22) from governor housing.

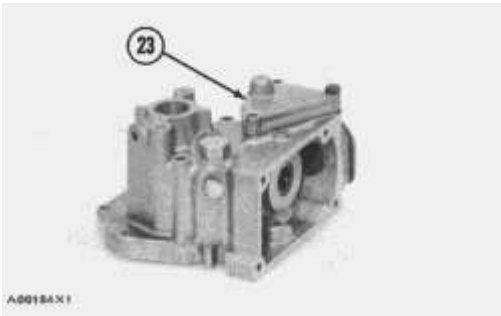

15. Remove cover (23) from governor housing.

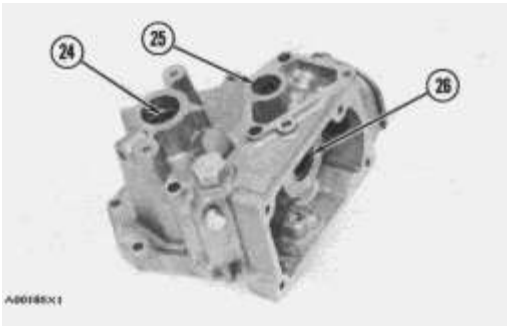

16. Remove seal (25) and bearing.

17. Remove seals (24) and (26) from governor housing.

## Assemble Governor

Tools Needed		A	B
1P529	Handle	1	1
1P457	Drive Plate		1
1P471	Drive Plate		1

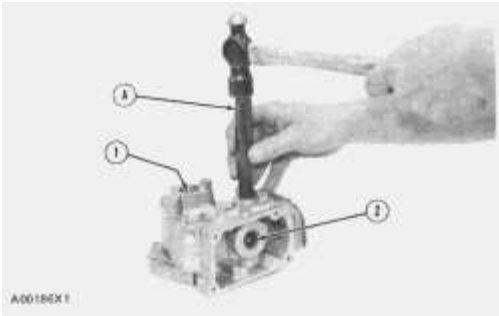

1. Install bearing and seal in the housing with tool (A). The lip of the seal must be toward the bearing.
2. Install seal (1) in housing with tool (A). The lip of seal must be toward inside of housing.
3. Install seal (2) in housing with tooling (B). The lip of seal must be toward the inside of housing.

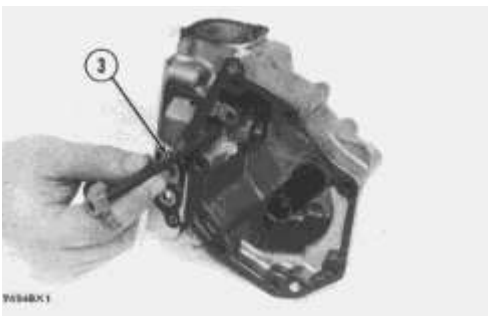

4. Install shaft (3) in the housing.

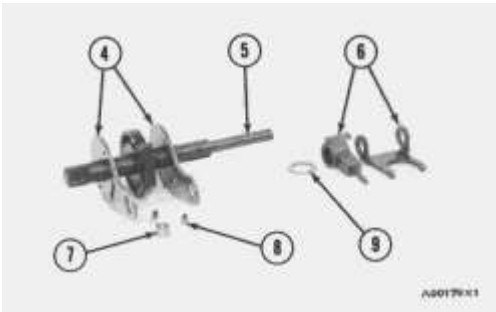

5. Install plates (4), spacers (8) and pin (7) on shaft.
6. Install shaft (5) in housing and through washer (9) and levers (6).

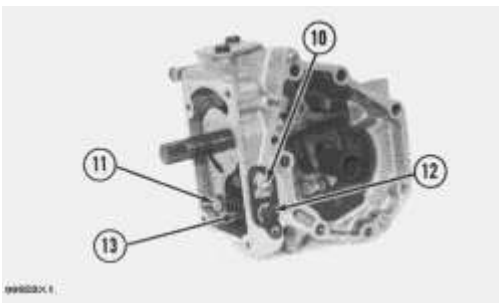

7. Install pin (11) in holes of the plates.
8. Install screw (10) and locknut for high idle adjustment.

9. Install spring (13) and guide.

10. Install bolts (12) and washer for low idle adjustment.

11. Push plate and pin (11) over toward the bolt (12) and tighten the bolt.

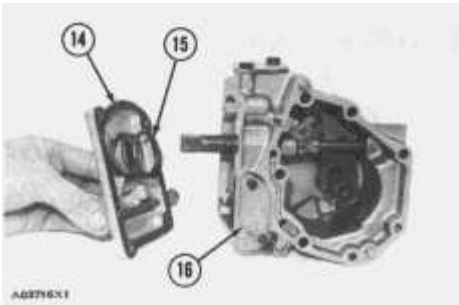

12. Install seal in cover with tooling (B). The lip of seal must be toward the inside.

13. Install spring (15) in the cover. Install cover (14) on housing.

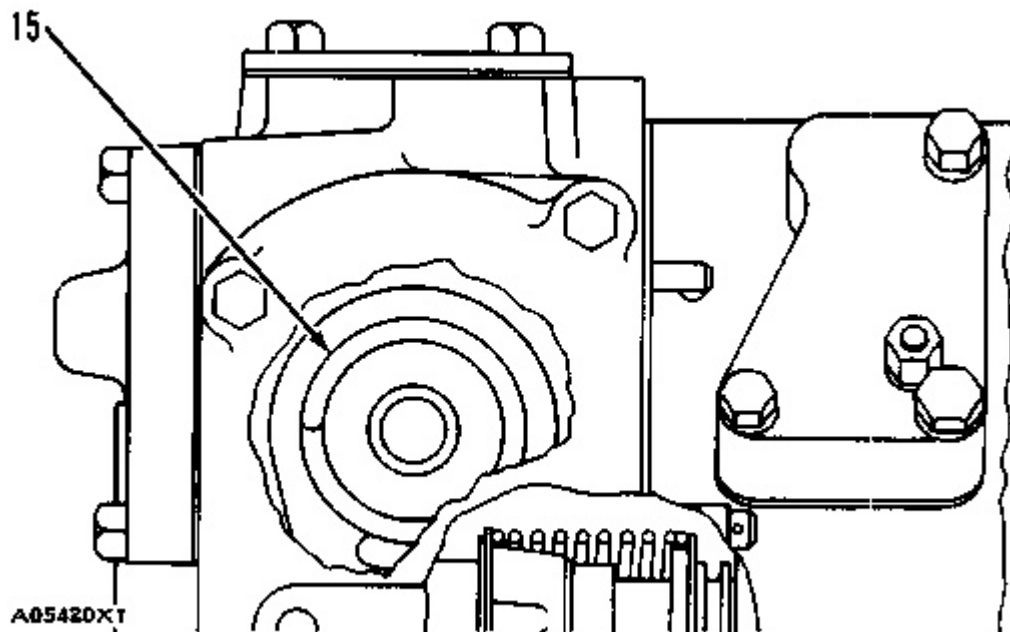

---

### NOTICE

**The spring (15) must be installed with the end of spring as shown.**

---

14. Install cover (16) for the idle adjustment screws.



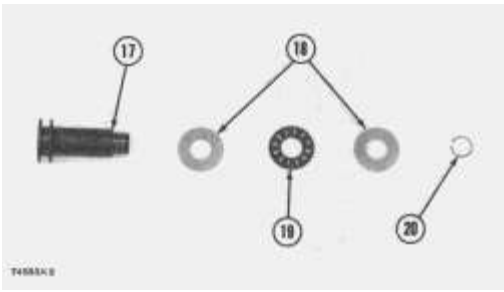

**15.** Install bearing (19) between the races (18) on riser (follower) (17). Install ring (20) that holds the washers on the riser (follower).

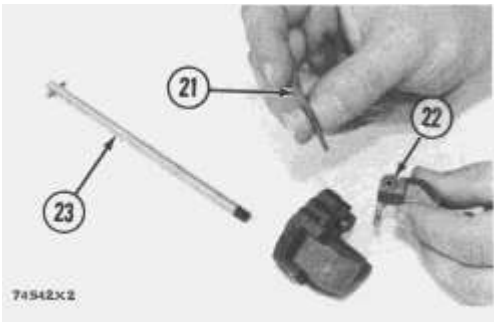

**16.** Install pin in shaft (23).

**17.** Install flyweights (22) and pin (21).

**18.** Install shaft (23) in the flyweight assembly.

end by:

**a)** connection of governor to fuel injection pump housing

---

Product: TRACK LOADER

Model: 941 TRACK LOADER 80H

Configuration: 941B TRAXCAVATOR 80H05703-UP (MACHINE) POWERED BY 3304 ENGINE

## Disassembly and Assembly

### SLEEVE METERING FUEL SYSTEM FOR FOUR AND SIX CYLINDER 4.75"

Media Number -REG01400-01

Publication Date -01/03/1974

Date Updated -17/03/2010

REG01400008

## Fuel Check Valve And Bypass Valve

SMCS - 1264-15; 1264-16

### Remove Fuel Check Valve And Bypass Valve

Tools Needed		A
2P8315	Bracket Assembly	1

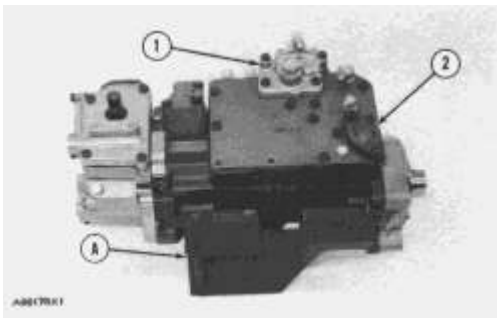

1. Remove fuel from the pump housing and install on tool (A).
2. Remove cover (2) from top cover.
3. Remove fuel inlet and return housing (1) from top cover.

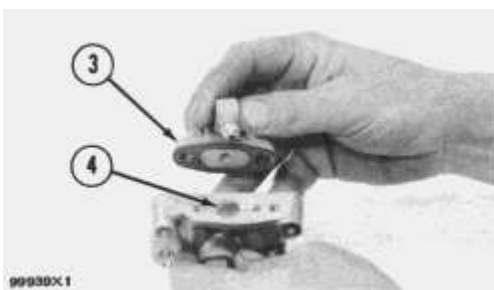

4. Remove elbow (3) and disc (4) from fuel inlet and return housing.

**NOTE:** The function of the disc (4) is to keep the fuel in the pump housing from returning to the tank when the engine is not in operation. If the fuel tank is higher than the fuel pump housing, disc and housing is not needed.

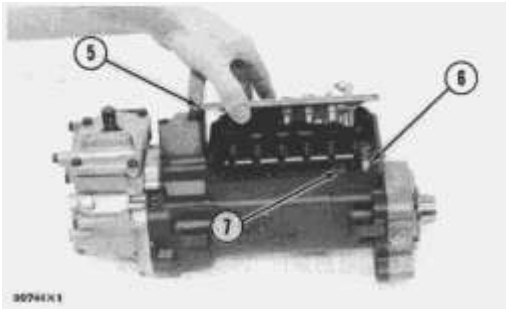

5. Remove cover (5) and fuel channel from pump housing.

6. Remove spring and bypass valve (6) from housing.

7. Remove check valve (7).

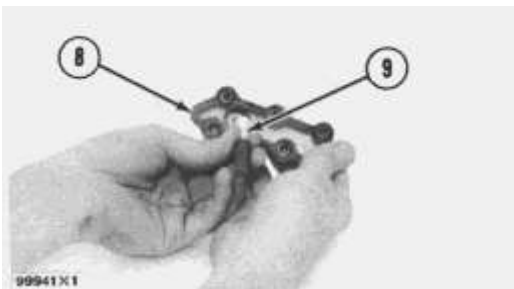

8. Remove fuel channel (8) and check valve from cover.

9. Remove check valve (9) and spring from fuel channel.

**NOTE:** Earlier fuel systems have two check valves (7) and (9). Check valve (9) is not needed. Remove check valve (9) and fill the hole in fuel channel with weld or replace channel.

## Install Fuel Check Valve And Bypass Valve

Tools Needed		A
2P8315	Bracket Assembly	1

1. Install fuel channel (1) on cover (2).

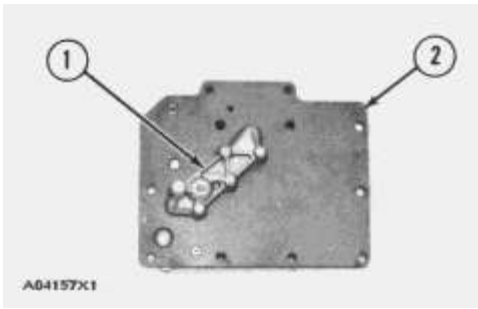

2. Install spring and bypass valve (4) in housing with the rounded end up.

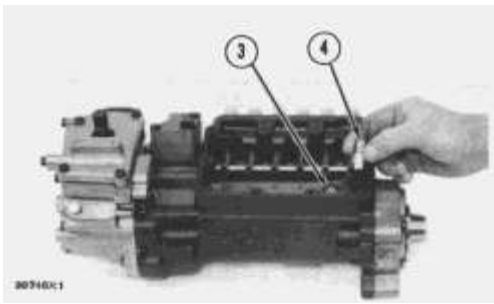

3. Install check valve (3) evenly in pump housing.

**NOTE:** Do not install a check valve that is bent.

4. Install cover on pump housing. Be sure the bypass valve spring is in the groove in the cover.

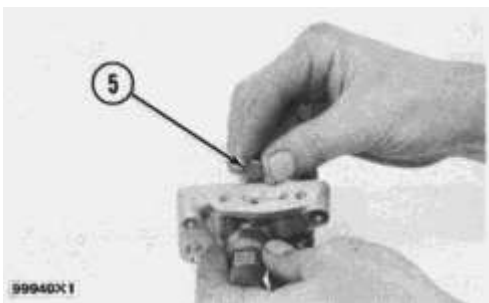

5. Install disc (5) and elbow on fuel inlet and return housing.

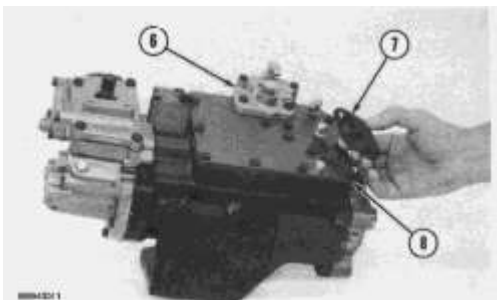

6. Install fuel inlet and return housing (6) on cover (8).

7. Install cover (7) on cover (8).

8. Remove fuel injection pump housing and governor from tool (A).

---

Thank you so much for reading.  
Please click the “Buy Now!”  
button below to download the  
complete manual.



After you pay.

You can download the most  
perfect and complete manual in  
the world immediately.

Our support email:

[ebooklibonline@outlook.com](mailto:ebooklibonline@outlook.com)