

Product: VIBRATORY COMPACTOR

Model: CB-434B VIBRATORY COMPACTOR 6AL

Configuration: CB-434B Vibratory Compactor 6AL00001-00087 (MACHINE) POWERED BY 3054 Engine

Disassembly and Assembly 3054 Engine for Caterpillar Built Machines

Media Number -SEN6241-13

Publication Date -01/08/2008

Date Updated -04/08/2008

i01598347

Exhaust Manifold - Remove and Install - Type 2 Engines and 7BJ Engines

SMCS - 1059-010

Removal Procedure

Start By:

- A. Remove the turbocharger. Refer to Disassembly and Assembly, "Turbocharger - Remove".
- B. Remove the air inlet manifold. Refer to Disassembly and Assembly, "Air Inlet Manifold - Remove and Install".

Note: For a complete description of Type 1 and Type 2 Engines, refer to the Disassembly and Assembly, "Engine Design" topic.

NOTICE

Keep all parts clean from contaminants.

Contaminants may cause rapid wear and shortened component life.

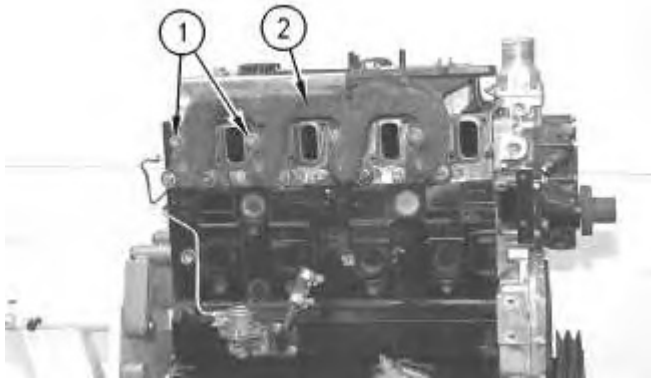

Illustration 1

g00557287

Typical example

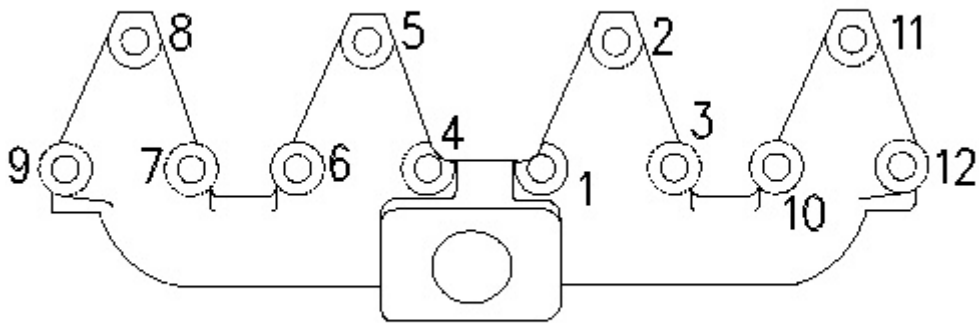

Illustration 2

g00557337

1. Remove exhaust manifold nuts or bolts (1) in reverse order of the numbered sequence.
2. Remove exhaust manifold (2) from the engine.

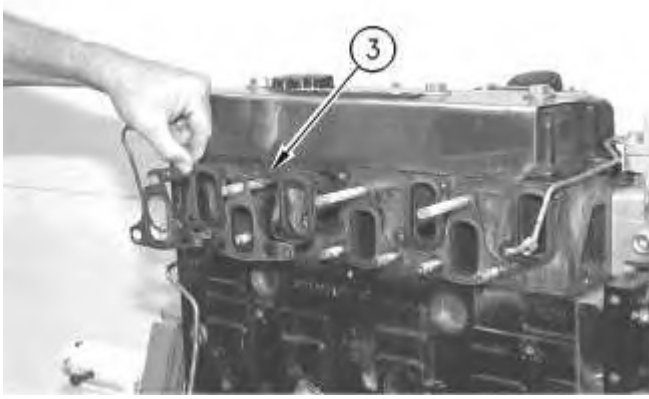

Illustration 3

g00557351

Typical example

3. Remove exhaust manifold gaskets (3) from the engine.
4. Remove old sealant from stud threads.

Installation Procedure

NOTICE

Keep all parts clean from contaminants.

Contaminants may cause rapid wear and shortened component life.

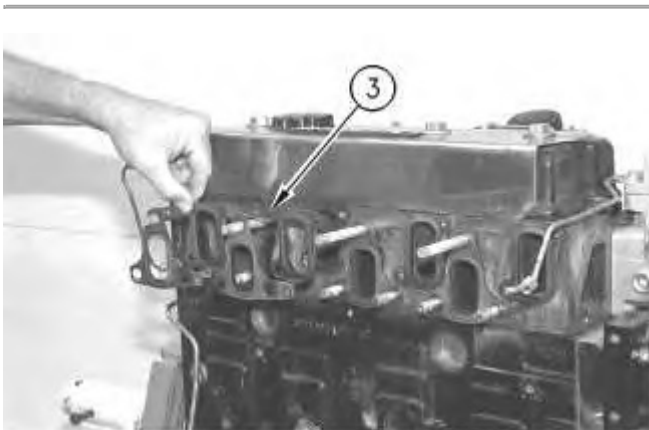

Illustration 4

g00557351

Typical example

1. Inspect the condition of the gaskets. If the gaskets are damaged, use new parts for replacement. Install exhaust manifold gaskets (3) on the cylinder head. Apply **4C-9507 Retaining Compound** to the stud threads.

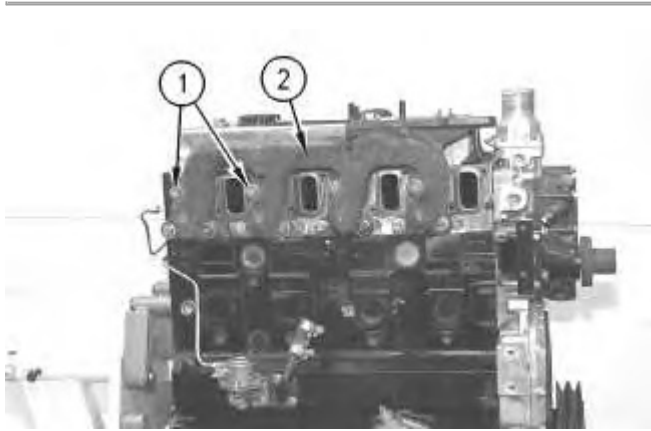

Illustration 5

g00557287

Typical example

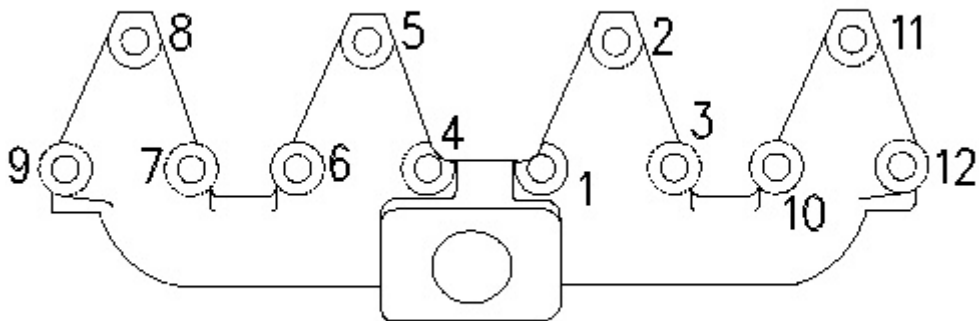

Illustration 6

g00557337

NOTICE

Damage to the exhaust manifold can occur if the exhaust manifold is not aligned and tightened correctly.

2. Install exhaust manifold (2) on the cylinder head.

Note: Some of the exhaust manifolds have large clearance holes for the bolts. If a new exhaust manifold is installed ensure that the **148-7132** Ferrule mountings that are supplied with the exhaust manifold are installed.

3. Install exhaust manifold nuts or bolts (1). Tighten the exhaust manifold nuts or bolts in the numerical sequence to a torque of 44 N·m (33 lb ft).

End By:

- a. Install the air inlet manifold. Refer to Disassembly and Assembly, "Air Inlet Manifold - Remove and Install".
 - b. Install the turbocharger. Refer to Disassembly and Assembly, "Turbocharger - Install".
-

Product: VIBRATORY COMPACTOR

Model: CB-434B VIBRATORY COMPACTOR 6AL

Configuration: CB-434B Vibratory Compactor 6AL00001-00087 (MACHINE) POWERED BY 3054 Engine

Disassembly and Assembly 3054 Engine for Caterpillar Built Machines

Media Number -SEN6241-13

Publication Date -01/08/2008

Date Updated -04/08/2008

i01068659

Exhaust Manifold - Remove and Install - Type 1 Engines and 9RM Engines

SMCS - 1059-010

Removal Procedure

Start By:

- A. Remove the turbocharger. Refer to Disassembly and Assembly, "Turbocharger - Remove".

Note: For a complete description of Type 1 and Type 2 Engines, refer to the Disassembly and Assembly, "Engine Design" topic.

NOTICE

Keep all parts clean from contaminants.

Contaminants may cause rapid wear and shortened component life.



Illustration 1

g00542541

Typical example

1. Remove exhaust manifold nuts (1) .
2. Remove exhaust manifold (2) and the gasket.

Installation Procedure

NOTICE

Keep all parts clean from contaminants.

Contaminants may cause rapid wear and shortened component life.



Illustration 2

g00542541

Typical example

1. Inspect the condition of the gasket. Replace the gasket, if necessary.
2. Install the gasket and exhaust manifold (2) .
3. Install exhaust manifold nuts (1). Tighten the plated nuts to a torque of 44 N·m (32 lb ft). Tighten the nuts that are not plated to a torque of 50 N·m (37 lb ft).

End By: Install the turbocharger. Refer to Disassembly and Assembly, "Turbocharger - Install".

Product: VIBRATORY COMPACTOR

Model: CB-434B VIBRATORY COMPACTOR 6AL

Configuration: CB-434B Vibratory Compactor 6AL00001-00087 (MACHINE) POWERED BY 3054 Engine

Disassembly and Assembly 3054 Engine for Caterpillar Built Machines

Media Number -SEN6241-13

Publication Date -01/08/2008

Date Updated -04/08/2008

i02870246

Inlet Manifold - Remove - Type 2 Engines and 7BJ Engines

SMCS - 1058-011

Removal Procedure

Note: For a complete description of Type 1 and Type 2 engines, refer to Disassembly and Assembly, "Engine Design".

NOTICE

Keep all parts clean from contaminants.

Contaminants may cause rapid wear and shortened component life.

NOTICE

Care must be taken to ensure that fluids are contained during performance of inspection, maintenance, testing, adjusting and repair of the product. Be prepared to collect the fluid with suitable containers before opening any compartment or disassembling any component containing fluids.

Refer to Special Publication, NENG2500, "Caterpillar Dealer Service Tool Catalog" for tools and supplies suitable to collect and contain fluids on Caterpillar products.

Dispose of all fluids according to local regulations and mandates.

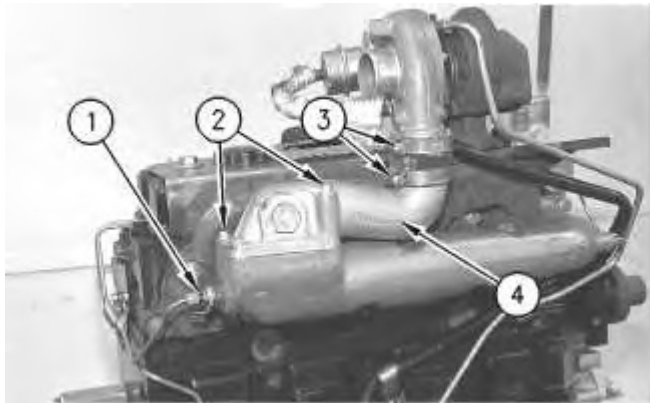

Illustration 1

g00557838

Typical example

1. Disconnect tube (1) from the air inlet heater.
2. Loosen hose clamps (3) and slide the hose toward the turbocharger.
3. Remove four bolts (2) and remove elbow (4) from the air inlet manifold.

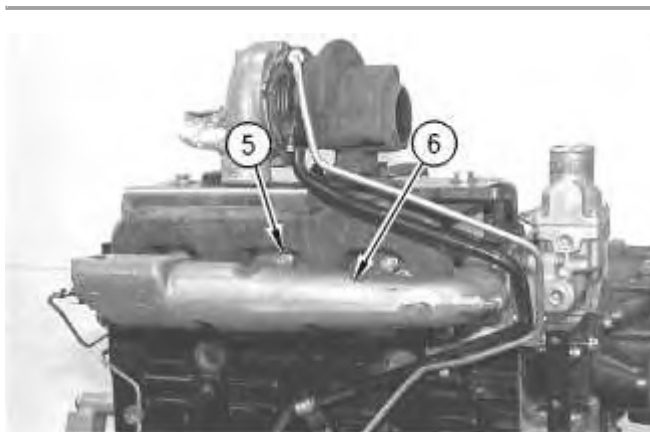

Illustration 2

g00558245

Typical example

4. Remove bolts (5) that fasten air inlet manifold (6) to the engine.
 5. Remove air inlet manifold (6) .
-

Product: VIBRATORY COMPACTOR

Model: CB-434B VIBRATORY COMPACTOR 6AL

Configuration: CB-434B Vibratory Compactor 6AL00001-00087 (MACHINE) POWERED BY 3054 Engine

Disassembly and Assembly 3054 Engine for Caterpillar Built Machines

Media Number -SEN6241-13

Publication Date -01/08/2008

Date Updated -04/08/2008

i02870245

Inlet Manifold - Remove - Type 1 Engines and 9RM Engines

SMCS - 1058-011

Removal Procedure

Note: For a complete description of Type 1 and Type 2 engines, refer to Disassembly and Assembly, "Engine Design".

NOTICE

Keep all parts clean from contaminants.

Contaminants may cause rapid wear and shortened component life.

NOTICE

Care must be taken to ensure that fluids are contained during performance of inspection, maintenance, testing, adjusting and repair of the product. Be prepared to collect the fluid with suitable containers before opening any compartment or disassembling any component containing fluids.

Refer to Special Publication, NENG2500, "Caterpillar Dealer Service Tool Catalog" for tools and supplies suitable to collect and contain fluids on Caterpillar products.

Dispose of all fluids according to local regulations and mandates.

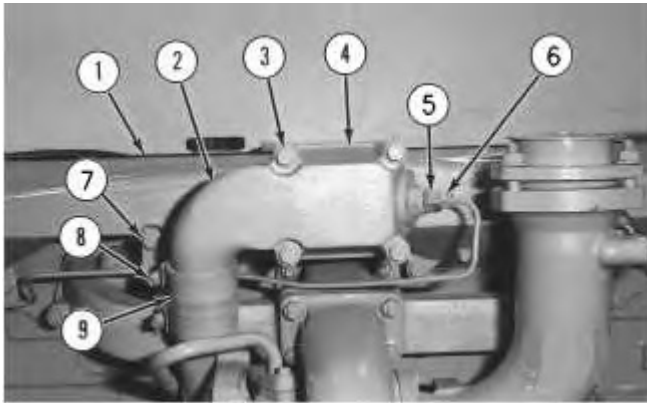

Illustration 1

g00545513

Typical example

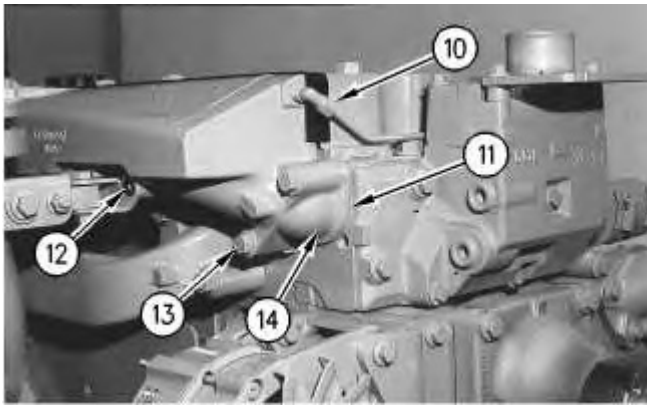

Illustration 2

g00545514

Typical example

1. Disconnect electrical connector (5) for the air inlet heater.
2. Disconnect fuel line (6) to the air inlet heater.
3. Remove two bolts (7) that hold the bracket for fuel line (6) in position.
4. Loosen two hose clamps (8) and slide hose (9) toward the turbocharger.
5. Remove four bolts (3) in order to remove elbow (2) and gasket (4) .
6. Disconnect boost pressure hose (10) .
7. Remove bolts (12) that hold the turbocharger support to air inlet manifold (14) .
8. Remove bolts (13) that hold air inlet manifold (14) to the cylinder head.

9. Remove air inlet manifold (14) and gaskets (11) .

10. Remove seal (1) .

Product: VIBRATORY COMPACTOR

Model: CB-434B VIBRATORY COMPACTOR 6AL

Configuration: CB-434B Vibratory Compactor 6AL00001-00087 (MACHINE) POWERED BY 3054 Engine

Disassembly and Assembly 3054 Engine for Caterpillar Built Machines

Media Number -SEN6241-13

Publication Date -01/08/2008

Date Updated -04/08/2008

i02870254

Inlet Manifold - Install - Type 1 Engines and 9RM Engines

SMCS - 1058-012

Installation Procedure

Note: For a complete description of Type 1 and Type 2 engines, refer to Disassembly and Assembly, "Engine Design".

NOTICE

Keep all parts clean from contaminants.

Contaminants may cause rapid wear and shortened component life.

1. Inspect the gaskets for wear or damage. If the gaskets are worn or damaged, use new parts for replacement.

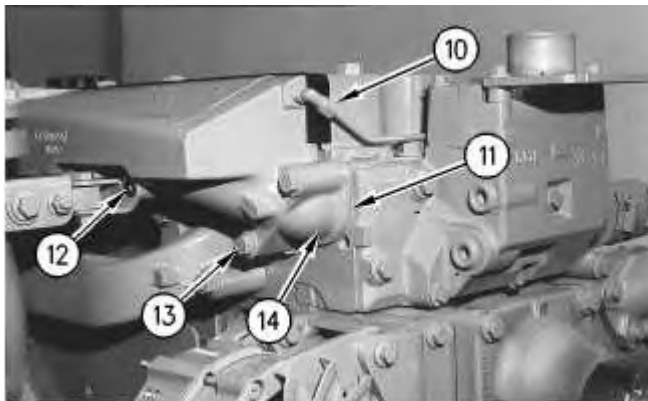

Typical example

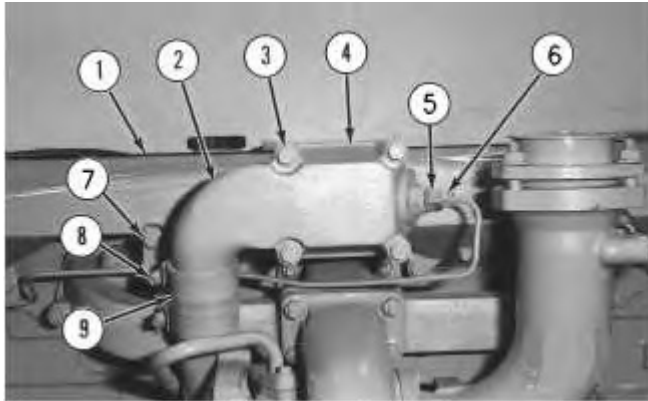

Illustration 2

Typical example

2. Install seal (1) on the engine.
3. Position gaskets (11) and air inlet manifold (14) on the engine.

Note: Ensure that the front gaskets and the rear gaskets are installed with the notch at the top left side. The center gasket can be installed in either direction.

4. Install bolts (13) .
 5. Position the turbocharger support on air inlet manifold (14) and install bolts (12) .
 6. Connect boost pressure hose (10) .
 7. Install gasket (4) and elbow (2) with four bolts (3) .
 8. Slide hose (9) in position and tighten hose clamps (8) .
 9. Place the bracket for fuel line (6) in position and install two bolts (7) .
 10. Connect fuel line (6) to the air inlet heater.
 11. Connect electrical connector (5) for the air inlet heater.
-

Product: VIBRATORY COMPACTOR

Model: CB-434B VIBRATORY COMPACTOR 6AL

Configuration: CB-434B Vibratory Compactor 6AL00001-00087 (MACHINE) POWERED BY 3054 Engine

Disassembly and Assembly 3054 Engine for Caterpillar Built Machines

Media Number -SEN6241-13

Publication Date -01/08/2008

Date Updated -04/08/2008

i02870255

Inlet Manifold - Install - Type 2 Engines and 7BJ Engines

SMCS - 1058-012

Installation Procedure

Note: For a complete description of Type 1 and Type 2 engines, refer to Disassembly and Assembly, "Engine Design".

NOTICE

Keep all parts clean from contaminants.

Contaminants may cause rapid wear and shortened component life.

1. Inspect the gaskets for wear or damage. If the gaskets are worn or damaged, use new parts for replacement.

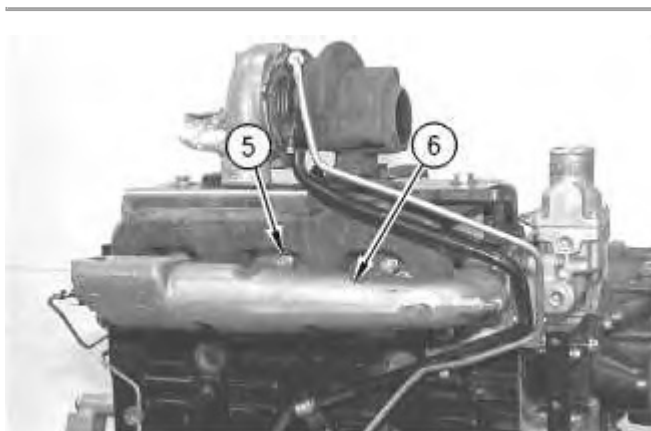

Typical example

2. Install the gasket and air inlet manifold (6) with bolts (5) . Tighten bolts (5) to a torque of 33 N·m (24 lb ft).

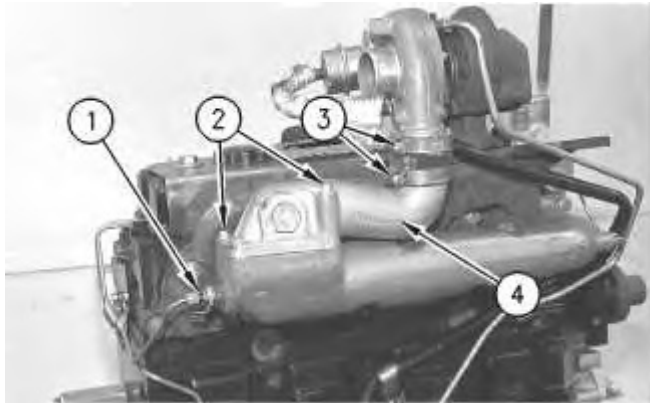

Illustration 2

Typical example

3. Put the gasket and elbow (4) in position on the air inlet manifold.
 4. Install four bolts (2) .
 5. Slide the hose into position and tighten hose clamps (3) .
 6. Connect tube (1) to the air inlet heater.
-

Product: VIBRATORY COMPACTOR

Model: CB-434B VIBRATORY COMPACTOR 6AL

Configuration: CB-434B Vibratory Compactor 6AL00001-00087 (MACHINE) POWERED BY 3054 Engine

Disassembly and Assembly 3054 Engine for Caterpillar Built Machines

Media Number -SEN6241-13

Publication Date -01/08/2008

Date Updated -04/08/2008

i01458210

Inlet and Exhaust Valve Springs - Remove and Install

SMCS - 1108-010

Removal Procedure

Table 1

Required Tools			
Tool	Part Number	Part Description	Qty
A	9U-6195	Valve Spring Compressor	1

Start By:

- A. Remove the rocker shaft. Refer to Disassembly and Assembly, "Rocker Shaft and Pushrod - Remove".

NOTICE

Keep all parts clean from contaminants.

Contaminants may cause rapid wear and shortened component life.

Note: Before you begin the removal of the valve springs, refer to the Specifications Module, "Cylinder Head Valves" topic for appropriate information on the valve springs.

1. Ensure that the piston is at the top center position.

Note: If the rocker arm assembly has not been removed, rotate the crankshaft in the normal direction of rotation until the inlet valve of the appropriate cylinder has just opened and the

exhaust valve has not fully closed. If the rocker arm assembly has been removed, go to Step 2.

NOTICE

Do not turn the crankshaft while the valve springs are removed.

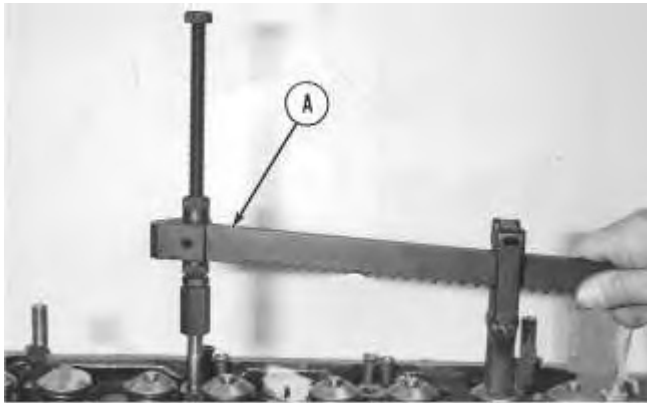

Illustration 1

g00762206

- a. Install Tool (A) .
- b. Compress the valve springs in order to open the valve.
- c. Turn the crankshaft until the piston touches the valve.
- d. Continue to turn the crankshaft and release the pressure of Tool (A) until the piston is at the top center position.

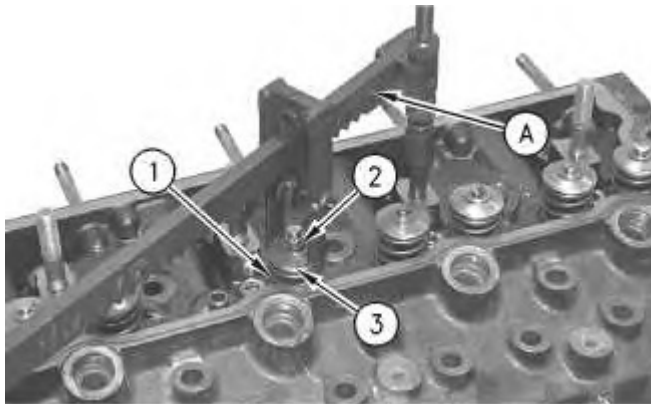

Illustration 2

g00762210

2. Install Tool (A) .

3. Compress valve springs (1). Remove two valve keepers (2) .

NOTICE

Ensure that the valve spring is compressed squarely or damage to the valve stem may occur.

4. Release the pressure on Tool (A). Remove valve spring retainer (3) and valve springs (1) .

Note: If you are replacing all of the valve springs, the procedure can be done on two cylinders at the same time. The procedure can be done on cylinder 1 and cylinder 4, or on cylinder 2 and cylinder 3.

NOTICE

Do not turn the crankshaft while the valve springs are removed.

Installation Procedure

Table 2

Required Tools			
Tool	Part Number	Part Description	Qty
A	9U-6195	Valve Spring Compressor	1

NOTICE

Keep all parts clean from contaminants.

Contaminants may cause rapid wear and shortened component life.

1. Place the new valve springs into position.

Note: Ensure that the closed damper coils are toward the cylinder head if double valve springs are used.

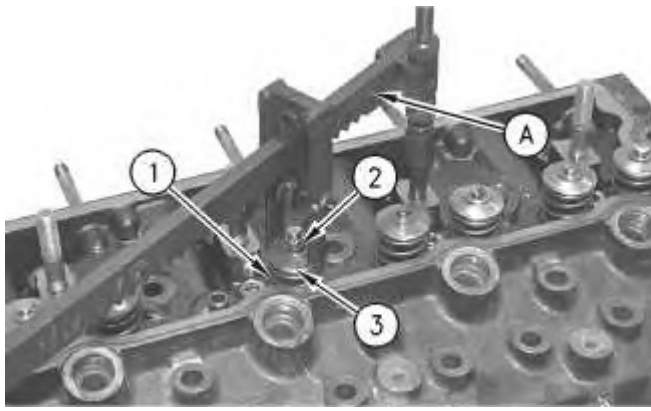

Illustration 3

g00762210

2. Install valve spring retainer (3) .
3. Install Tool (A). Compress valve springs (1) .

NOTICE

Ensure that the valve spring is compressed squarely or damage to the valve stem may occur.

4. Install two valve keepers (2) .
5. Release the pressure slowly on Tool (A). Remove Tool (A). Strike the top of the valves with a soft faced hammer in order to ensure that the valve keepers are properly installed.

Note: If you are replacing all of the valve springs the procedure can be done on two cylinders at the same time. The procedure can be done on cylinder 1 and cylinder 4, or on cylinder 2 and cylinder 3.

End By: Install the rocker shaft. Refer to Disassembly and Assembly, "Rocker Shaft and Pushrod - Install".

Thank you so much for reading.
Please click the “Buy Now!”
button below to download the
complete manual.



After you pay.

You can download the most
perfect and complete manual in
the world immediately.

Our support email:

ebooklibonline@outlook.com