

Product: VIBRATORY COMPACTOR

Model: CS68B VIBRATORY COMPACTOR 509

Configuration: CS68B, CP68B Vibratory Soil Compactor 50900001-UP (MACHINE) POWERED BY C7.1 Engine

Disassembly and Assembly

CS56B, CP56B, CS66B, CS68B and CP68B Vibratory Soil Compactors Machine Systems

Media Number -UENR0144-03

Publication Date -01/02/2016

Date Updated -12/02/2016

i06998102

Final Drive Planetary (Drum Propel) - Disassemble

SMCS - 5655-015

Disassembly Procedure

Table 1

Required Tools			
Tools	Part Number	Part Description	QTY
A	8B-7548	Push-Puller Tool Gp	1
	1P-0520	Driver Gp	1
	8T-0207	Bolt	2
	5P-8247	Hard Washer	2
B	136-1452	Retaining Ring Pliers	1
C	1P-0510	Driver Gp	1
D	138-7574	Link Bracket	2

Start By:

- a. Remove the final drive planetary.

Note: Cleanliness is an important factor. Before the disassembly procedure, the exterior of the component should be thoroughly cleaned. This will help to prevent dirt from entering the internal mechanism.

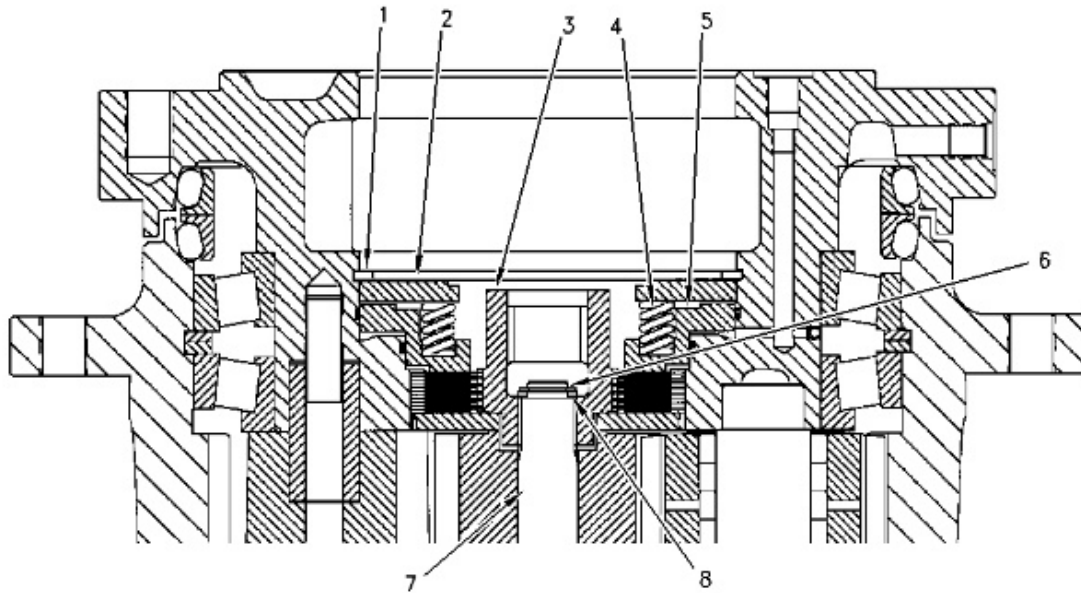

Illustration 1

g00977445

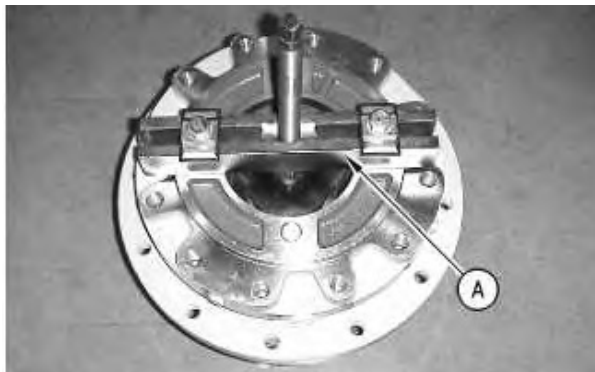

Illustration 2

g00831857

 **WARNING**

Sudden release of spring force can cause injury.

To prevent the possibility of injury, follow the procedure to relieve the spring pressure.

1. Install Tooling (A) on the final drive planetary, as shown. Use Tooling (A) and compress springs (4) under retaining disc (2) enough to eliminate the spring pressure on retaining ring (1).
2. Use Tooling (B) and remove retaining ring (1).

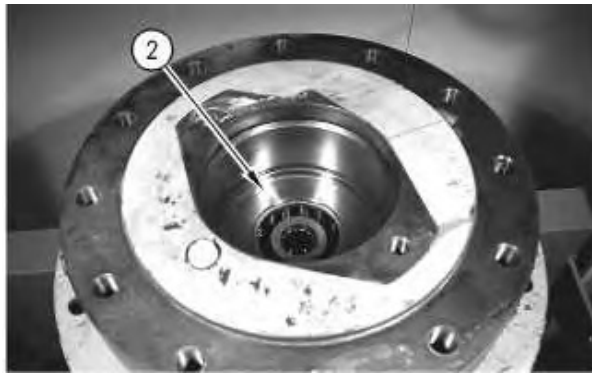

Illustration 3

g00831858

3. Remove retaining disc (2).
4. Remove springs (4) from brake piston (5).
5. Remove brake piston (5) from the hub.
6. Remove retaining ring (6), shims (8), and coupling (3) from sun gear (7).

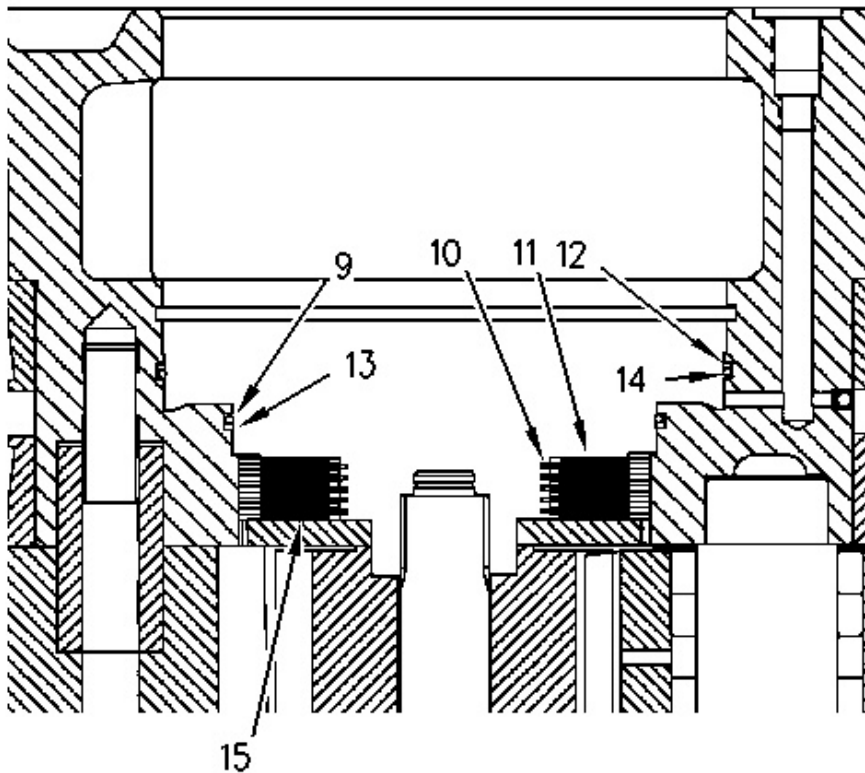

Illustration 4

g00977458

7. Remove discs (11) and friction discs (10).
8. Remove O-ring seals (9) and (14). Remove backup rings (13) and (12).

Note: When discs (11) and friction discs (10) are removed, some of the final drive planetaries will have shim (15) under the last disc.

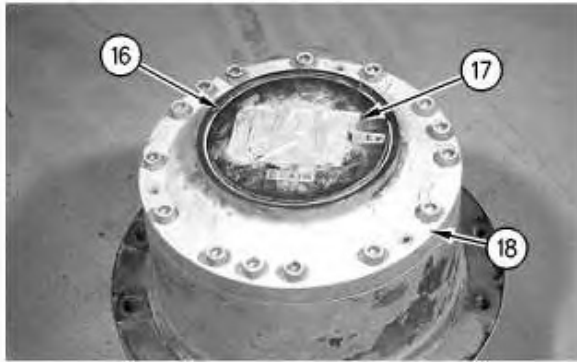

Illustration 5

g00977461

9. Remove retaining ring (16). Remove flange cover (17) from input ring gear (18).

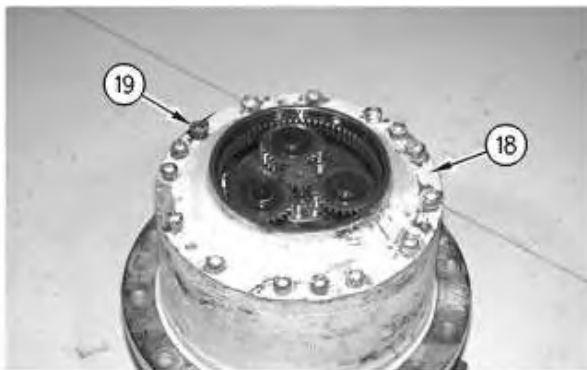

Illustration 6

g00977463

10. Remove bolts (19). Remove input ring gear (18) from the housing.

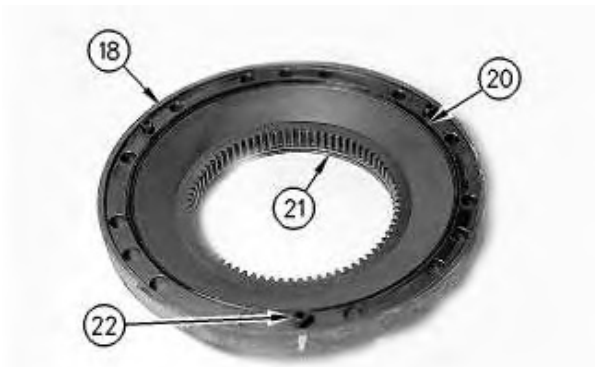

Illustration 7

g00977464

11. Remove O-ring seals (20) and (21) from input ring gear (18).
12. Remove dowels (22) from input ring gear (18).

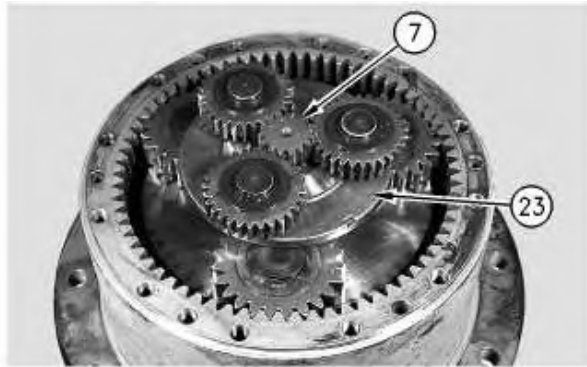

Illustration 8

g00977466

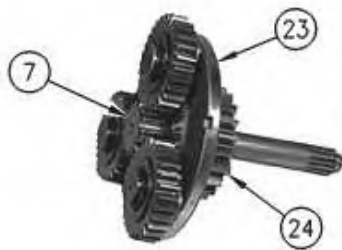

Illustration 9

g00977467

13. Remove sun gear (7), planetary carrier (23), and sun gear (24) from the housing.
14. Remove sun gears (7) and (24) from planetary carrier (23).



Illustration 10

g00831872

15. Remove retaining ring (26), antirotation washer (27), planetary gear (25), needle bearings (28), and the gear washer from gear pin (29).
16. Repeat Step 15 and remove the remaining two planetary gears.

17. Remove gear pins (29) from planetary carrier (23), if necessary.
18. Remove disc (30) from planetary carrier (23), if necessary.



Illustration 11

g00977595

19. Remove planetary carrier (31) from the housing.

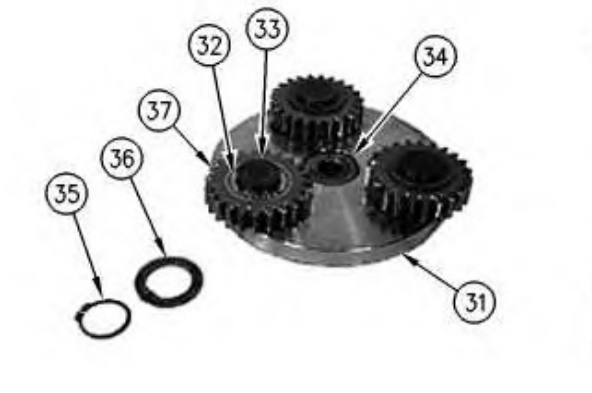
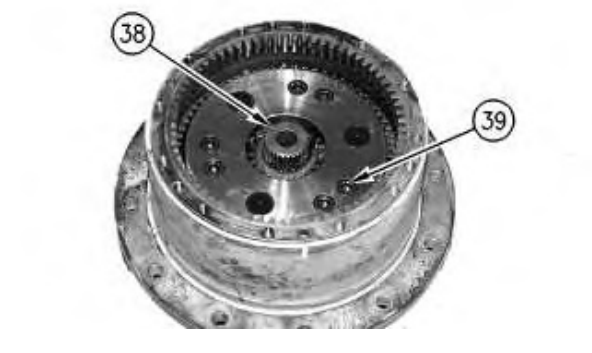

Illustration 12

g00831875

20. Remove retaining ring (35), gear washer (36), planetary gear (37), needle bearings (32), and the antirotation washer from gear pin (33).
21. Repeat Step 20 and remove the remaining two planetary gears.
22. Remove gear pins (33) from planetary carrier (31), if necessary.
23. Remove disc (34) from planetary carrier (31), if necessary.



24. Remove sun gear (38) and bolts (39).

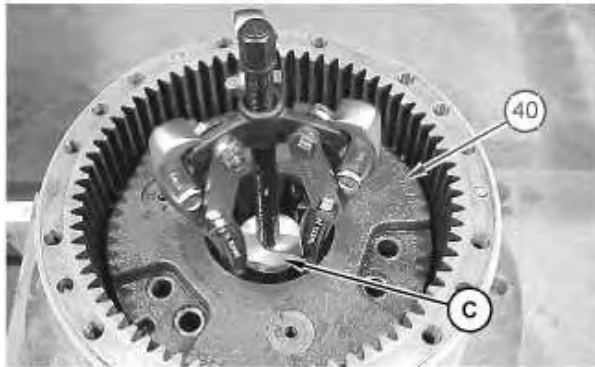

Illustration 14

g06193037

Typical Example

25. Use Tooling (C) and a suitable puller to remove planetary carrier (40).



Illustration 15

g00977635

26. Remove antirotation washers (41).

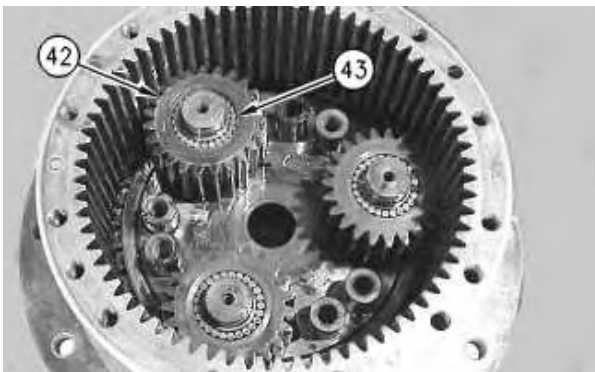

Illustration 16

g00977598

27. Remove planetary gears (42) and needle bearings (43) from the planetary gear pins. There are needle bearings on each of the planetary gear pins.
-



Illustration 17

g00978758

28. Remove planetary gear pins (44), antirotation washers (45), and retaining disc (46).

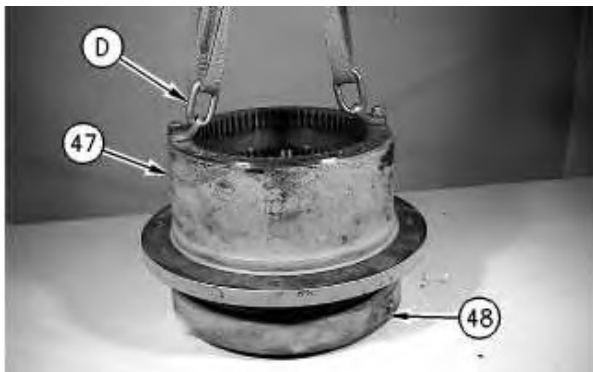

Illustration 18

g00978761

29. Use Tooling (D) and a suitable lifting device to remove housing (47) from hub (48). The weight of the hub is 43 kg (95 lb).

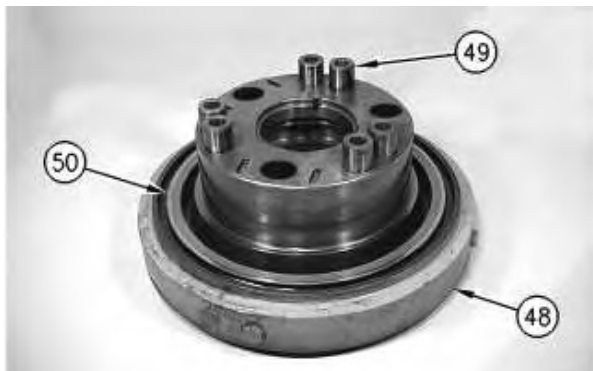

Illustration 19

g00978762

30. Remove bushings (49) from hub (47).
31. Remove the first half of Duo-Cone Seal (50).

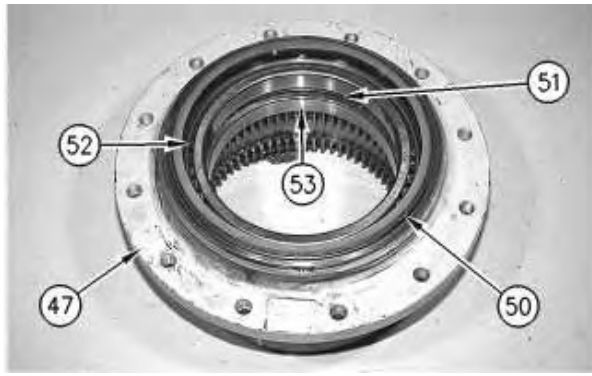

Illustration 20

g00978764

32. Remove the second half of Duo-Cone Seal (50) from housing (47).
 33. Remove bearings (52), bearing cups (53) and retaining rings (51).
-

Product: VIBRATORY COMPACTOR

Model: CS68B VIBRATORY COMPACTOR 509

Configuration: CS68B, CP68B Vibratory Soil Compactor 50900001-UP (MACHINE) POWERED BY C7.1 Engine

Disassembly and Assembly CS56B, CP56B, CS66B, CS68B and CP68B Vibratory Soil Compactors Machine Systems

Media Number -UENR0144-03

Publication Date -01/02/2016

Date Updated -12/02/2016

i04782474

Final Drive Planetary (Drum Propel) - Disassemble

SMCS - 5655-015

Disassembly Procedure

Table 1

Required Tools			
Tools	Part Number	Part Description	QTY
A	8B-7548	Push-Puller Tool Gp	1
	1P-0520	Driver Gp	1
	8T-0207	Bolt	2
	5P-8247	Hard Washer	2
B	136-1452	Retaining Ring Pliers	1
C	1P-2320	Combination Puller	1
	1P-0510	Driver Gp	1
D	138-7574	Link Bracket	2

Start By:

- a. Remove the final drive planetary.
-

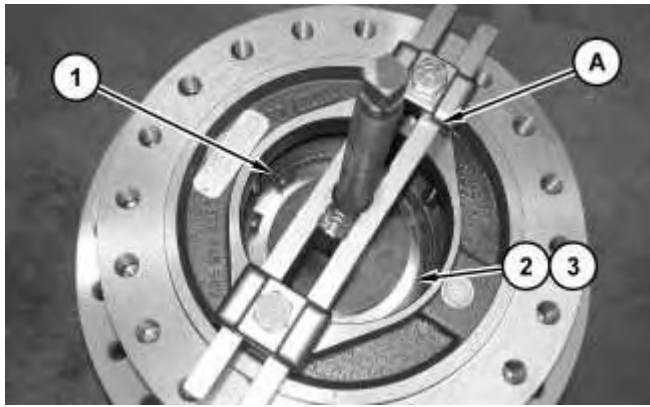

Illustration 1

g01415783



Sudden release of spring force can cause injury.

To prevent the possibility of injury, follow the procedure to relieve the spring pressure.

1. Install Tooling (A) on the final drive planetary, as shown. Use Tooling (A) and compress springs (3) under retaining disc (2) enough to eliminate the spring pressure on retaining ring (1).
2. Use Tooling (B) and remove retaining ring (1).

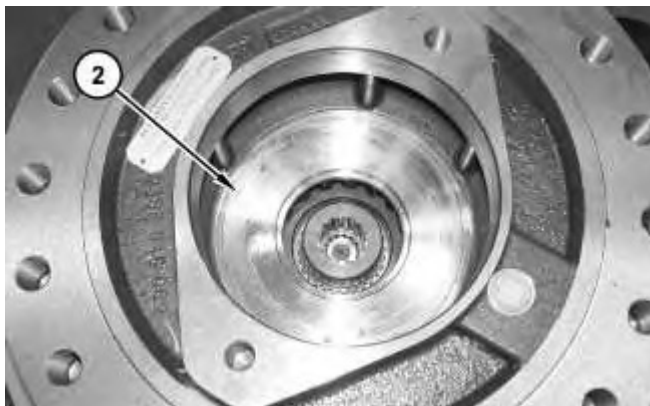

Illustration 2

g01415782

3. Remove retaining disc (2).

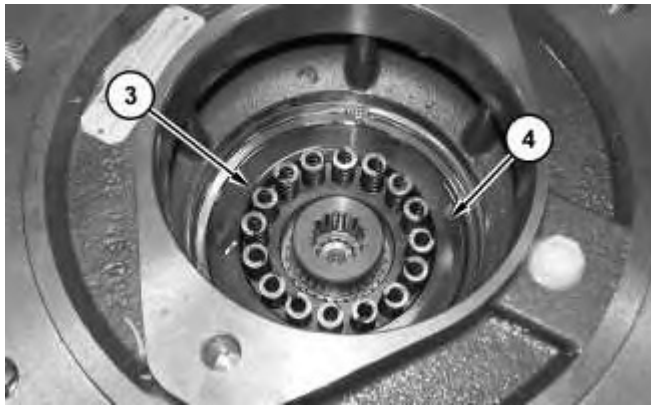

Illustration 3

g01415998

4. Remove springs (3) from brake piston (4).



Illustration 4

g01416182

5. Use two bolts in order to remove brake piston (4) from the hub.

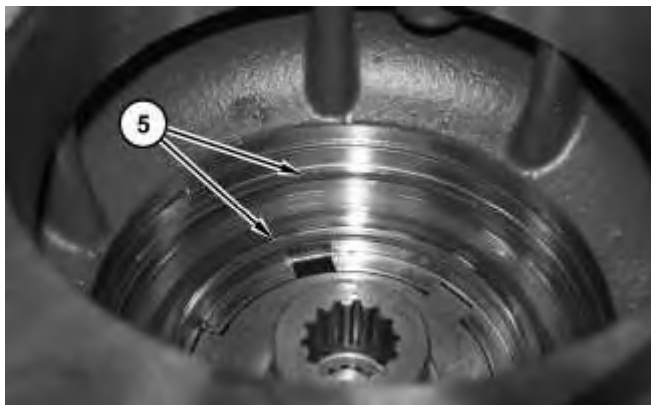

Illustration 5

g01416187

6. Remove O-ring seals (5).
-

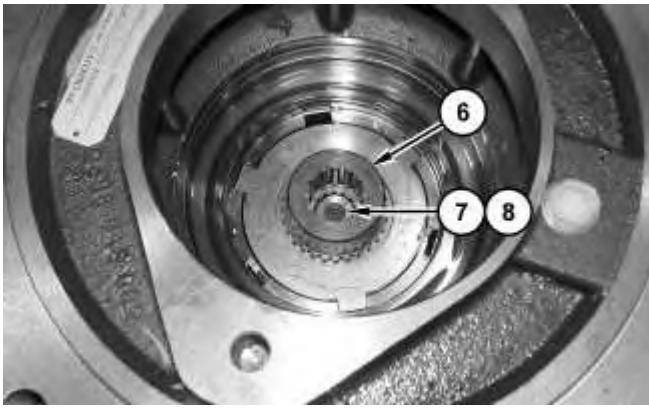

Illustration 6

g01416183

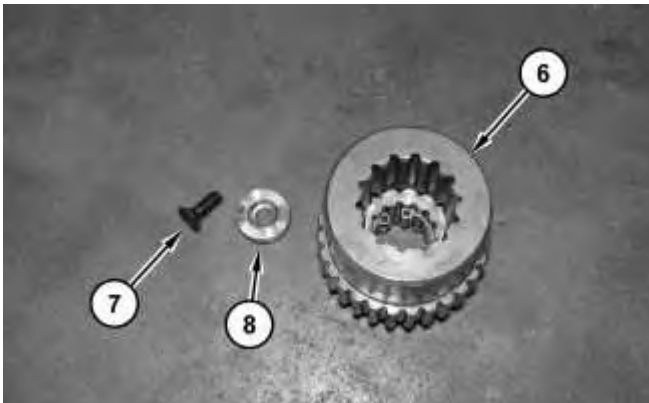

Illustration 7

g01416205

7. Remove bolt (7), washer (8), and coupling (6) from the hub, if equipped.

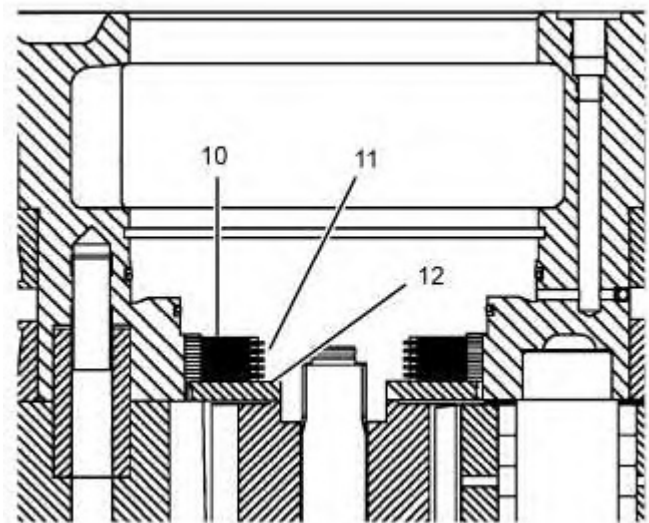

Illustration 8

g01416193

8. Remove discs (11), friction discs (10), and shims (12).

Note: When discs (11) and friction discs (10) are removed, some of the final drive planetaries will have shim (12) under the last disc.



Illustration 9

g02167113

9. Remove the bolts and cover (13).



Illustration 10

g02167114

10. Remove O-ring seal (14).



Illustration 11

g02167115

11. Remove the bolts and cover (15).

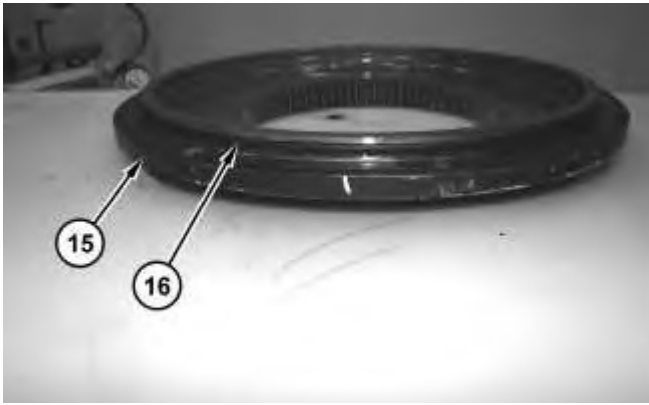

Illustration 12

g02167116

12. Remove O-ring seal (16) from cover (15).



Illustration 13

g02167118

13. Remove sun gear assembly (17).

14. Remove planetary carrier (18).

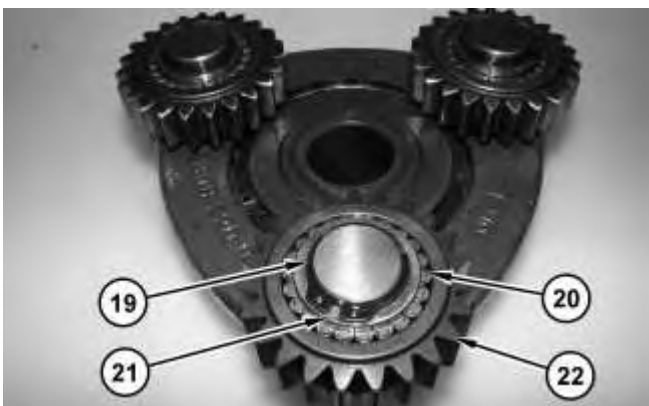

Illustration 14

g02167119

15. Use Tooling (B) and remove retaining ring (19). Remove antirotation washer (21), gear (22), and needle bearings (20).
16. Repeat Step 15 to disassemble the remaining two planetaries.



Illustration 15

g02167120

17. Remove planetary carrier (23).

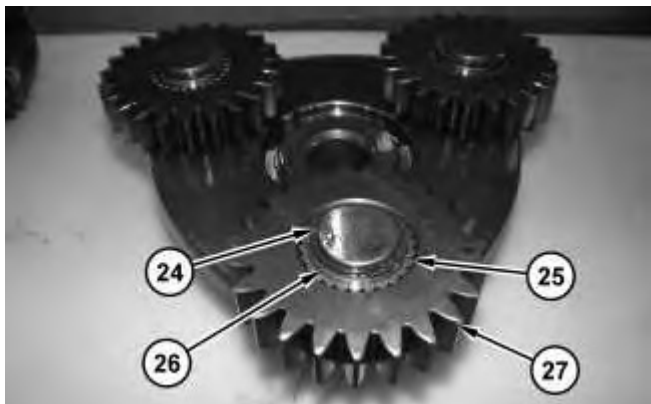
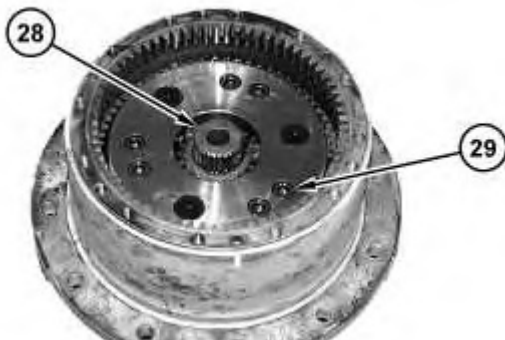

Illustration 16

g02167121

18. Use Tooling (B) and remove retaining ring (24). Remove antirotation washer (26), gear (27), and needle bearings (25).
19. Repeat Step 18 to disassemble the remaining two planetaries.



20. Remove sun gear (28) and bolts (29).

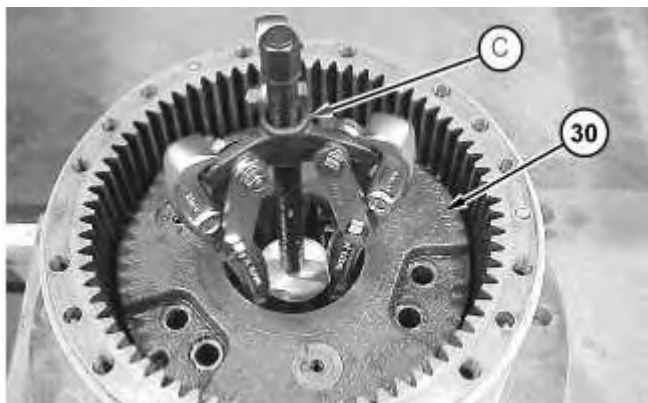

Illustration 18

21. Use Tooling (C) in order to remove planetary carrier (30).



Illustration 19

22. Remove antirotation washers (31).

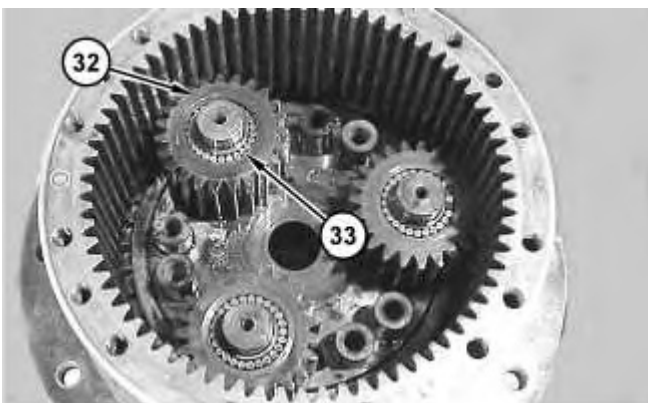

Illustration 20

23. Remove planetary gears (32) and needle bearings (33) from the planetary gear pins. There are needle bearings on each of the planetary gear pins.

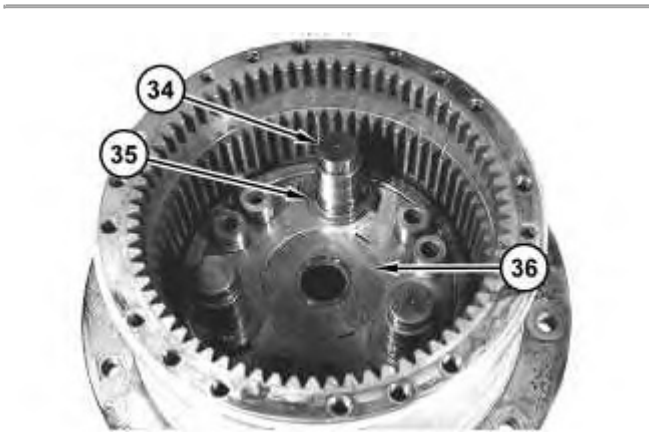

Illustration 21

g02890376

24. Remove planetary gear pins (34), antirotation washers (35) and retaining disc (36).



Illustration 22

g02890382

25. Use Tooling (D) and a suitable lifting device in order to remove housing (37) from hub (38). The weight of the hub (38) is 43 kg (95 lb).

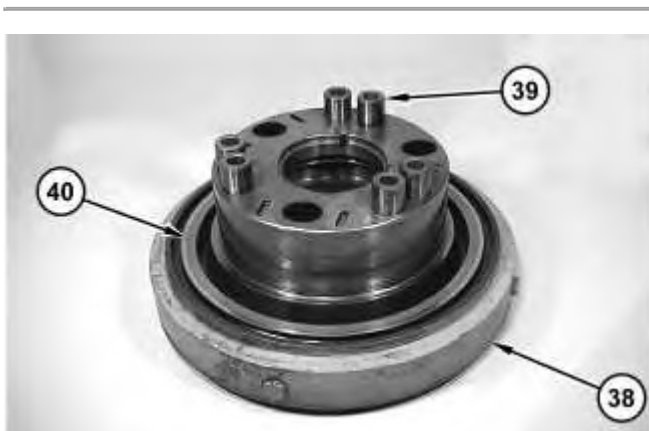

Illustration 23

g02890396

26. Remove bushings (39) from hub (38).

27. Remove the first half of Duo-Cone Seal (40).

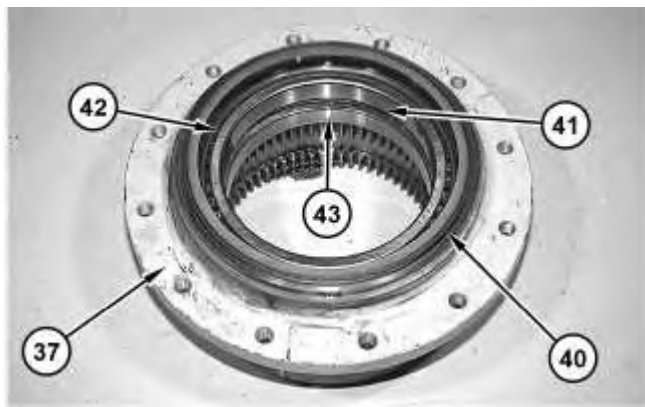

Illustration 24

g02890437

28. Remove the second half of Duo-Cone Seal (40) from housing (37).

29. Remove bearings (42), bearing cups (43) and retaining rings (41).

Product: VIBRATORY COMPACTOR

Model: CS68B VIBRATORY COMPACTOR 509

Configuration: CS68B, CP68B Vibratory Soil Compactor 50900001-UP (MACHINE) POWERED BY C7.1 Engine

Disassembly and Assembly CS56B, CP56B, CS66B, CS68B and CP68B Vibratory Soil Compactors Machine Systems

Media Number -UENR0144-03

Publication Date -01/02/2016

Date Updated -12/02/2016

i06781874

Final Drive Planetary (Drum Propel) - Assemble

SMCS - 5655-016

Assembly Procedure

Table 1

Required Tools			
Tools	Part Number	Part Description	Qty
A	8B-7548	Push-Puller Tool Gp	1
	1P-0520	Driver Gp	1
	8T-0207	Bolt	2
	5P-8247	Hard Washer	2
B	136-1452	Retaining Ring Pliers	1
D	138-7574	Link Bracket	2
E	220-5726	Duo-Cone Seal Installer As	1
F	5P-0960	Molybdenum Grease	1
G	9S-3263	Thread Lock Compound	1

Note: All of the components must be cleaned and inspected before assembly. If any of the components are beyond recommended limits, replace the components. Lubricate all moving parts with clean hydraulic oil during assembly. Assemble the final drive planetary with new seals.

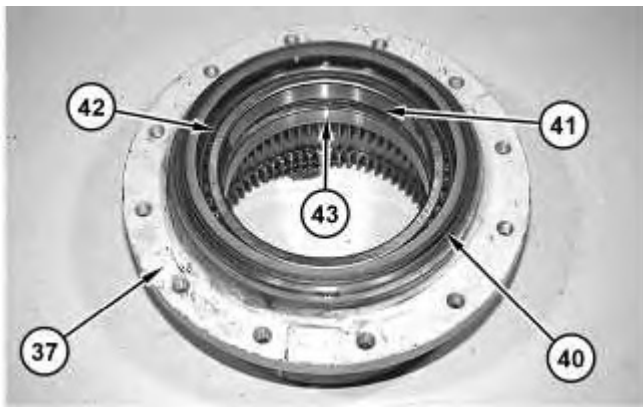

Illustration 1

g02890856

1. Install retaining rings (41), bearing cups (43) and bearings (42) in housing (37).
2. Use Tooling (E) to install Duo-Cone Seal (40) in housing (37). Refer to Disassembly and Assembly, "Duo-Cone Conventional Seals - Install" for the correct procedure.



Illustration 2

g02890876

3. Use Tooling (E) to install Duo-Cone Seal (40) in hub (38). Refer to Disassembly and Assembly, "Duo-Cone Conventional Seals - Install" for the correct procedure.
4. Install bushings (39) in hub (38).



Illustration 3

g02890896

5. Use Tooling (D) and a suitable lifting device to install housing (37) on hub (38). The weight of the housing (37) is 43 kg (95 lb).

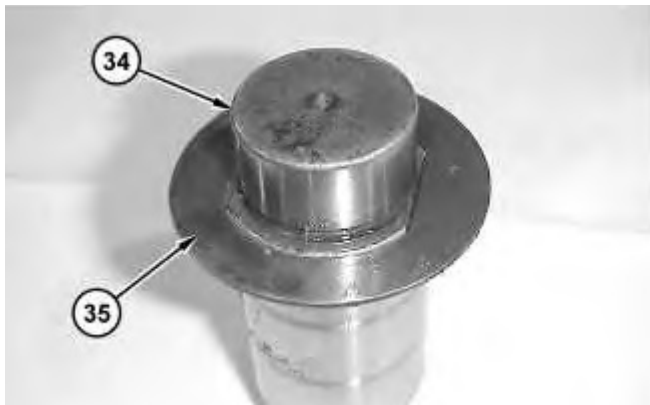

Illustration 4

g02890956

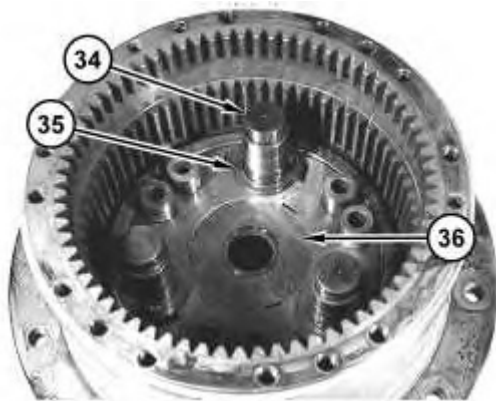

Illustration 5

g02890916

Note: Planetary gear pins (34) are not symmetrical. Install the longer end of the planetary gear pins (34) in hub (38).

Note: Planetary gear pins (34) and the bores in hub (38) must be clean to allow proper installation.

6. Apply Tooling (F) on the shoulders of planetary gear pins (34). Install antirotation washers (35) on planetary gear pins (34).
 7. Install antirotation washers (35) and planetary gear pins (34) in hub (38).
 8. Install retaining disc (36).
-

Thank you so much for reading.
Please click the “Buy Now!”
button below to download the
complete manual.



After you pay.

You can download the most
perfect and complete manual in
the world immediately.

Our support email:

ebooklibonline@outlook.com