

Product: VIBRATORY COMPACTOR

Model: CS-74B VIBRATORY COMPACTOR LCB

Configuration: CS74B CP74B Soil Compactor LCB00001-UP (MACHINE) POWERED BY C4.4 Engine

Disassembly and Assembly

CP74B, CS74B, CP76B, CS76B, CS78B and CS79B Vibratory Soil Compactors Machine Systems

Media Number -UENR0166-10

Publication Date -01/01/2015

Date Updated -01/10/2018

i04782474

Final Drive Planetary (Drum Propel) - Disassemble

SMCS - 5655-015

Disassembly Procedure

Table 1

Required Tools			
Tools	Part Number	Part Description	QTY
A	8B-7548	Push-Puller Tool Gp	1
	1P-0520	Driver Gp	1
	8T-0207	Bolt	2
	5P-8247	Hard Washer	2
B	136-1452	Retaining Ring Pliers	1
C	1P-2320	Combination Puller	1
	1P-0510	Driver Gp	1
D	138-7574	Link Bracket	2

Start By:

- a. Remove the final drive planetary.
-

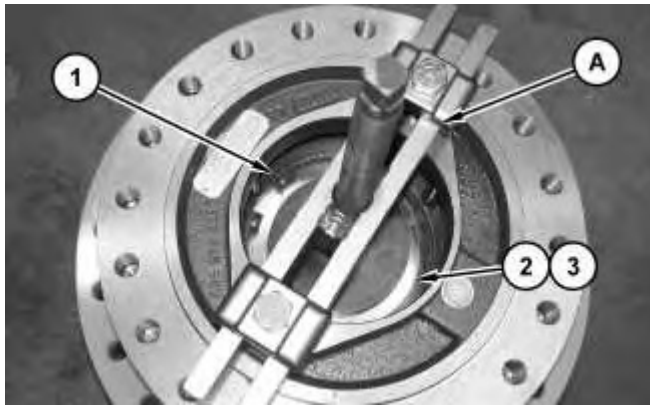

Illustration 1

g01415783

WARNING

Sudden release of spring force can cause injury.

To prevent the possibility of injury, follow the procedure to relieve the spring pressure.

1. Install Tooling (A) on the final drive planetary, as shown. Use Tooling (A) and compress springs (3) under retaining disc (2) enough to eliminate the spring pressure on retaining ring (1).
2. Use Tooling (B) and remove retaining ring (1).



Illustration 2

g01415782

3. Remove retaining disc (2).

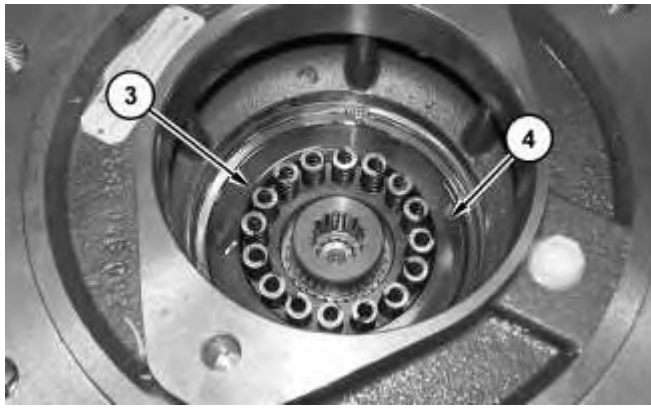

Illustration 3

g01415998

4. Remove springs (3) from brake piston (4).



Illustration 4

g01416182

5. Use two bolts in order to remove brake piston (4) from the hub.

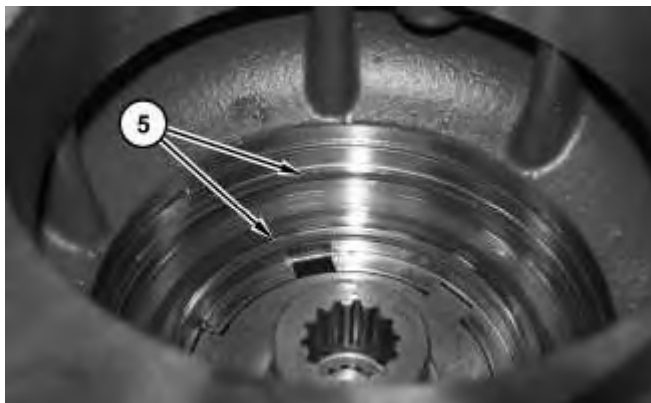

Illustration 5

g01416187

6. Remove O-ring seals (5).

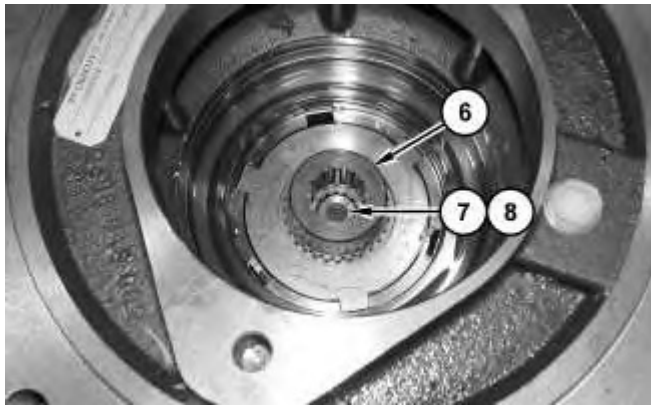

Illustration 6

g01416183

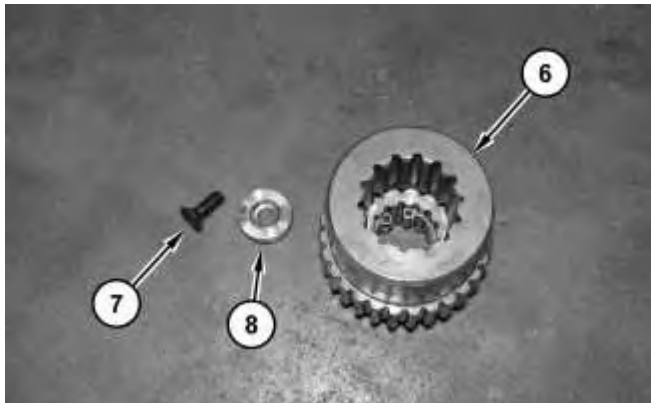

Illustration 7

g01416205

7. Remove bolt (7), washer (8), and coupling (6) from the hub, if equipped.

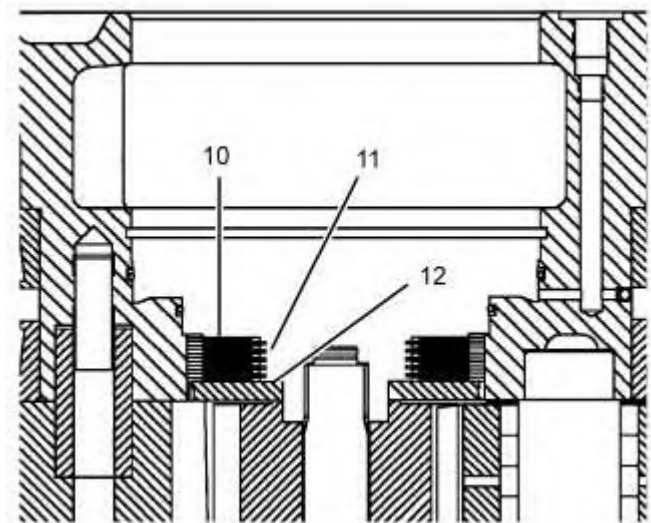

Illustration 8

g01416193

8. Remove discs (11), friction discs (10), and shims (12).

Note: When discs (11) and friction discs (10) are removed, some of the final drive planetaries will have shim (12) under the last disc.



Illustration 9

g02167113

9. Remove the bolts and cover (13).



Illustration 10

g02167114

10. Remove O-ring seal (14).



Illustration 11

g02167115

11. Remove the bolts and cover (15).

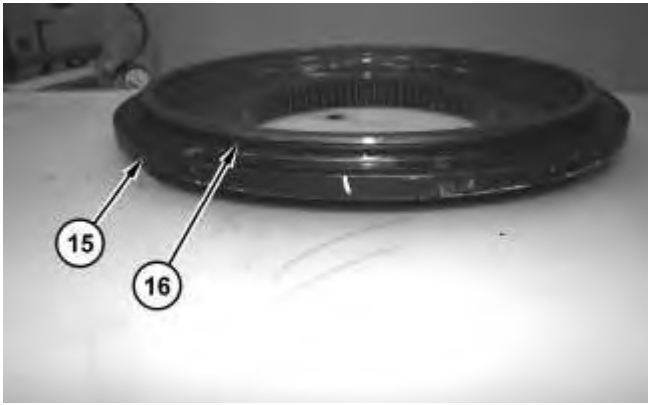

Illustration 12

g02167116

12. Remove O-ring seal (16) from cover (15).



Illustration 13

g02167118

13. Remove sun gear assembly (17).

14. Remove planetary carrier (18).

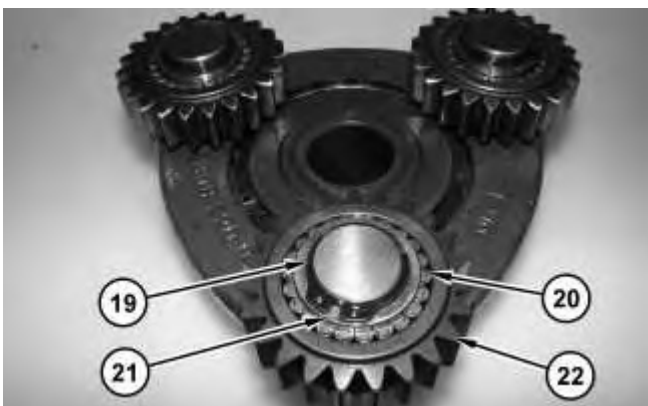

Illustration 14

g02167119

15. Use Tooling (B) and remove retaining ring (19). Remove antirotation washer (21), gear (22), and needle bearings (20).
16. Repeat Step 15 to disassemble the remaining two planetaries.



Illustration 15

g02167120

17. Remove planetary carrier (23).

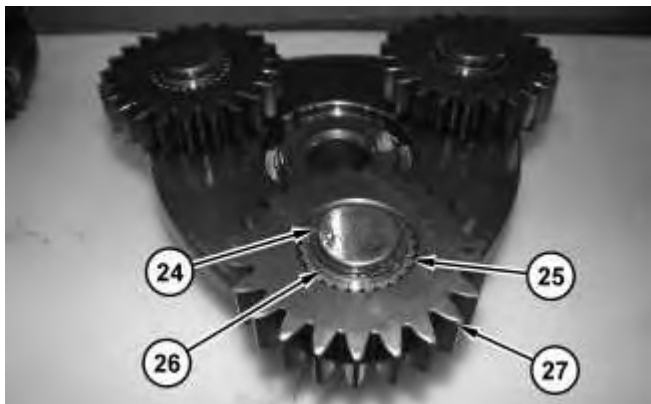

Illustration 16

g02167121

18. Use Tooling (B) and remove retaining ring (24). Remove antirotation washer (26), gear (27), and needle bearings (25).
19. Repeat Step 18 to disassemble the remaining two planetaries.



20. Remove sun gear (28) and bolts (29).

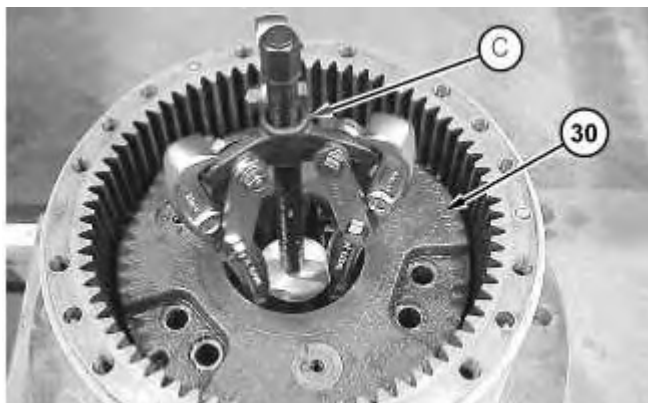

Illustration 18

21. Use Tooling (C) in order to remove planetary carrier (30).



Illustration 19

22. Remove antirotation washers (31).

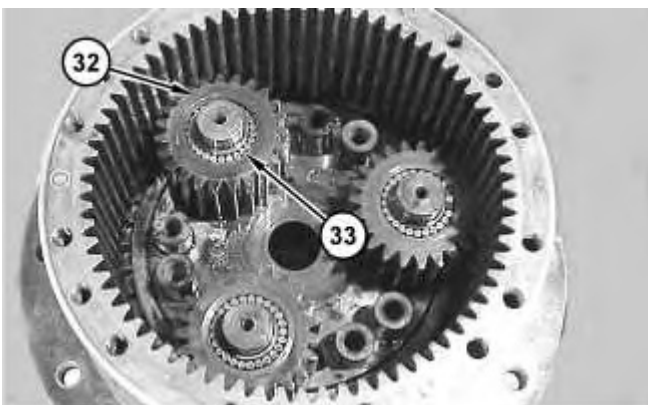

Illustration 20

23. Remove planetary gears (32) and needle bearings (33) from the planetary gear pins. There are needle bearings on each of the planetary gear pins.

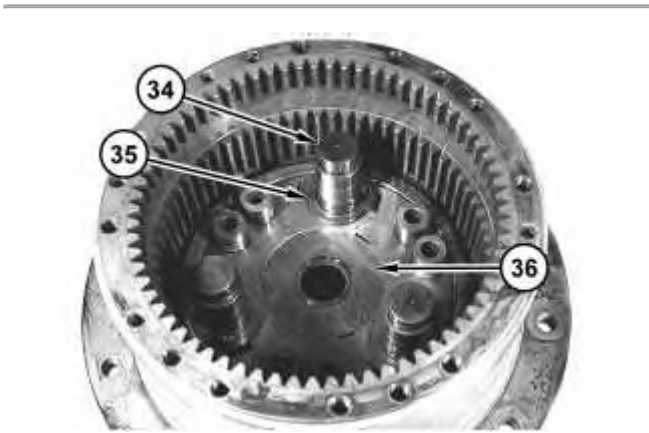

Illustration 21

g02890376

24. Remove planetary gear pins (34), antirotation washers (35) and retaining disc (36).



Illustration 22

g02890382

25. Use Tooling (D) and a suitable lifting device in order to remove housing (37) from hub (38). The weight of the hub (38) is 43 kg (95 lb).



Illustration 23

g02890396

26. Remove bushings (39) from hub (38).

27. Remove the first half of Duo-Cone Seal (40).

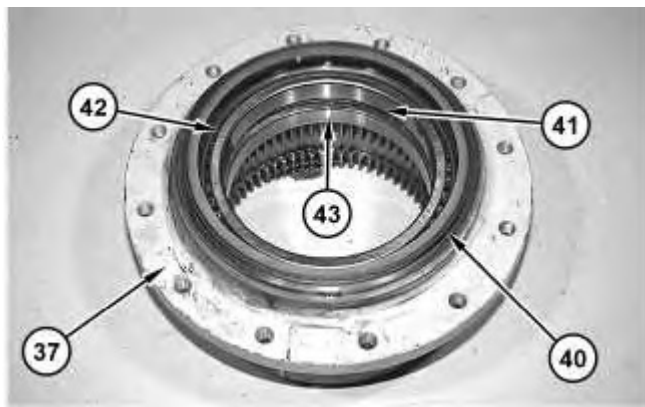

Illustration 24

g02890437

28. Remove the second half of Duo-Cone Seal (40) from housing (37).

29. Remove bearings (42), bearing cups (43) and retaining rings (41).

Product: VIBRATORY COMPACTOR

Model: CS-74B VIBRATORY COMPACTOR LCB

Configuration: CS74B CP74B Soil Compactor LCB00001-UP (MACHINE) POWERED BY C4.4 Engine

Disassembly and Assembly

CP74B, CS74B, CP76B, CS76B, CS78B and CS79B Vibratory Soil Compactors Machine Systems

Media Number -UENR0166-10

Publication Date -01/01/2015

Date Updated -01/10/2018

i06781874

Final Drive Planetary (Drum Propel) - Assemble

SMCS - 5655-016

Assembly Procedure

Table 1

Required Tools			
Tools	Part Number	Part Description	Qty
A	8B-7548	Push-Puller Tool Gp	1
	1P-0520	Driver Gp	1
	8T-0207	Bolt	2
	5P-8247	Hard Washer	2
B	136-1452	Retaining Ring Pliers	1
D	138-7574	Link Bracket	2
E	220-5726	Duo-Cone Seal Installer As	1
F	5P-0960	Molybdenum Grease	1
G	9S-3263	Thread Lock Compound	1

Note: All of the components must be cleaned and inspected before assembly. If any of the components are beyond recommended limits, replace the components. Lubricate all moving parts with clean hydraulic oil during assembly. Assemble the final drive planetary with new seals.

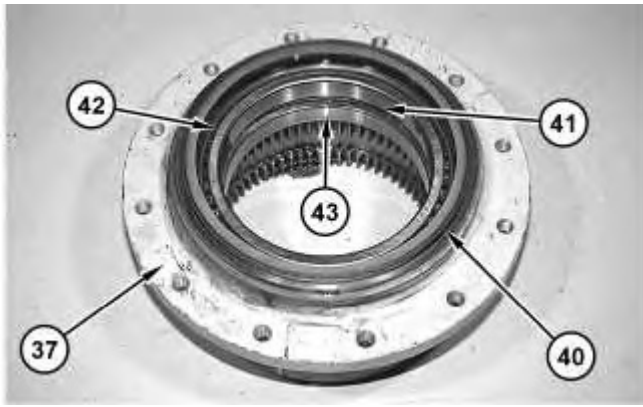

Illustration 1

g02890856

1. Install retaining rings (41), bearing cups (43) and bearings (42) in housing (37).
2. Use Tooling (E) to install Duo-Cone Seal (40) in housing (37). Refer to Disassembly and Assembly, "Duo-Cone Conventional Seals - Install" for the correct procedure.

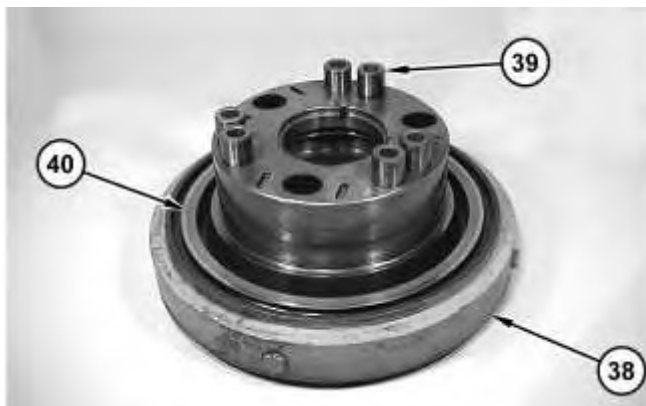

Illustration 2

g02890876

3. Use Tooling (E) to install Duo-Cone Seal (40) in hub (38). Refer to Disassembly and Assembly, "Duo-Cone Conventional Seals - Install" for the correct procedure.
4. Install bushings (39) in hub (38).



Illustration 3

g02890896

5. Use Tooling (D) and a suitable lifting device to install housing (37) on hub (38). The weight of the housing (37) is 43 kg (95 lb).

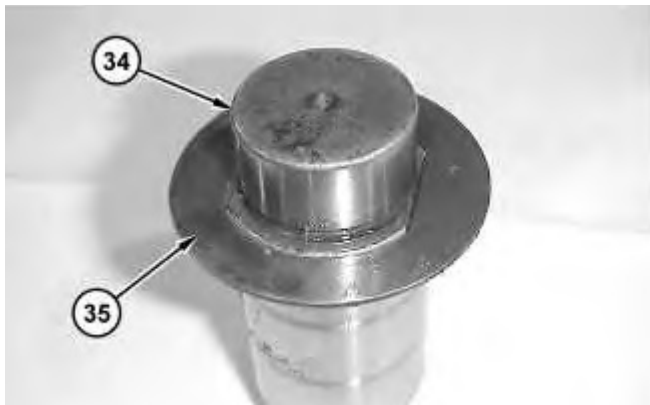

Illustration 4

g02890956

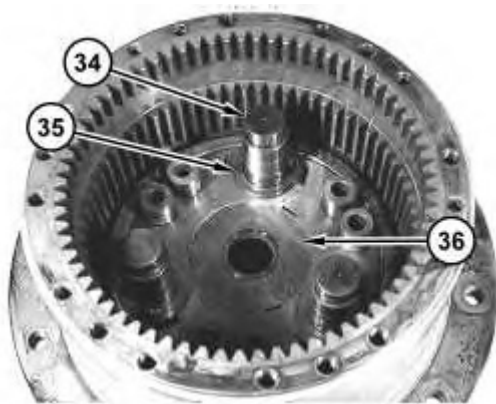

Illustration 5

g02890916

Note: Planetary gear pins (34) are not symmetrical. Install the longer end of the planetary gear pins (34) in hub (38).

Note: Planetary gear pins (34) and the bores in hub (38) must be clean to allow proper installation.

6. Apply Tooling (F) on the shoulders of planetary gear pins (34). Install antirotation washers (35) on planetary gear pins (34).
 7. Install antirotation washers (35) and planetary gear pins (34) in hub (38).
 8. Install retaining disc (36).
-

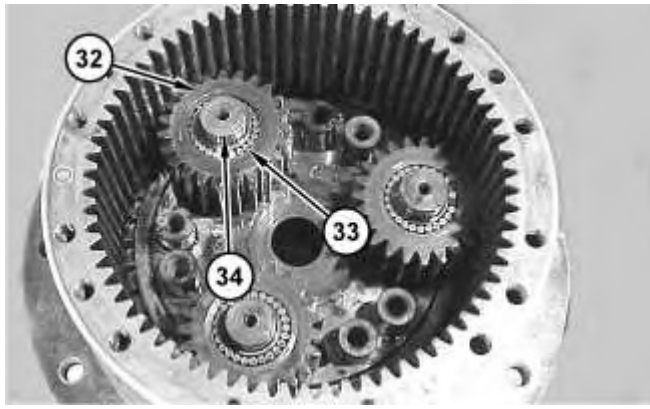

Illustration 6

g02891098

9. Apply Tooling (F) to needle bearings (33). Install 75 needle bearings (33) on planetary gear pin (34). There are three rows of needle bearings (33) on planetary gear pin (34). Each row contains 25 needle bearings (33). Install planetary gear (32) on the needle bearings (33) and the planetary gear pin (34).
10. Repeat Step 9 and install the remaining needle bearings and the remaining planetary gears.



Illustration 7

g02891097

11. Install antirotation washers (31).

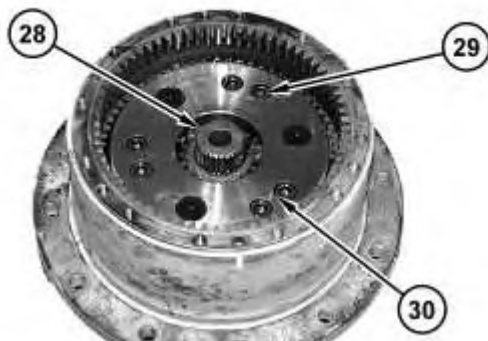

Illustration 8

g02891100

12. Apply Tooling (G) on the threads of bolts (29). Install planetary carrier (30), bolts (29) and sun gear (28). Tighten the bolts to a torque of $224 \pm 20 \text{ N}\cdot\text{m}$ ($165 \pm 15 \text{ lb ft}$).

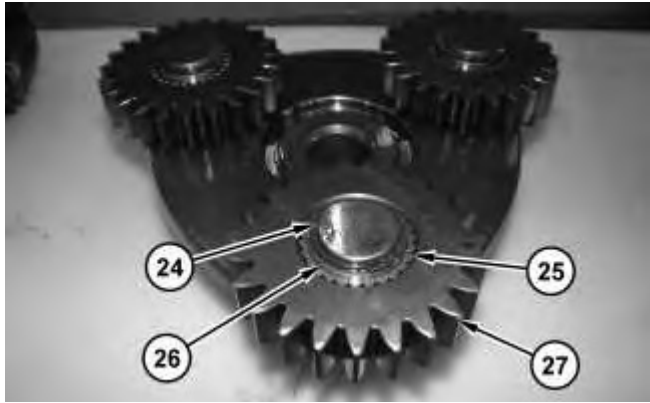

Illustration 9

g02167121

13. Install needle bearings (25), gear (27), and antirotation washer (26). Use Tooling (C) and install retaining ring (24).
14. Repeat Step 13 to assemble the remaining two planetaries.



Illustration 10

g02167120

15. Install planetary carrier (23).

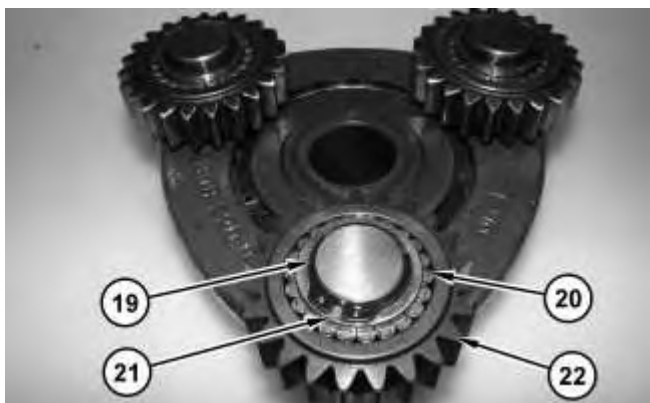

16. Install needle bearings (20), gear (22), and antirotation washer (21). Use Tooling (C) and install retaining ring (19).
17. Repeat Step 16 to assemble the remaining two planetaries.



Illustration 12

g02167118

18. Install planetary carrier (18).
19. Install sun gear assembly (17).

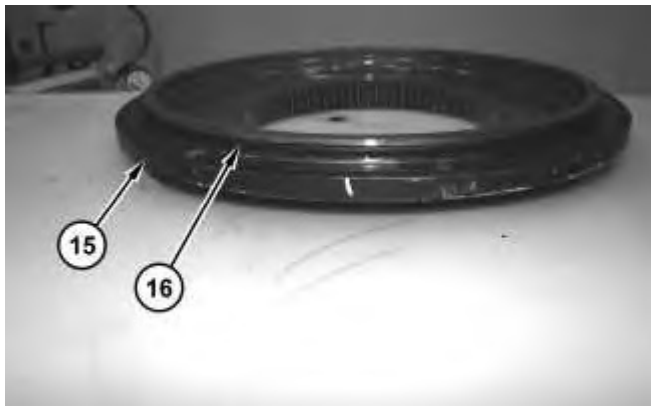

Illustration 13

g02167116

20. install O-ring cover (16) on cover (15).
-



Illustration 14

g02167115

21. Install cover (15) and the bolts.



Illustration 15

g02167114

22. Install O-ring seal (14).

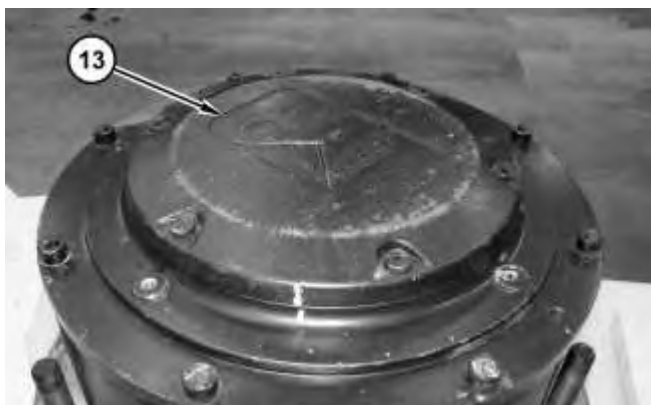

Illustration 16

g02167113

23. Install cover (13) and the bolts.

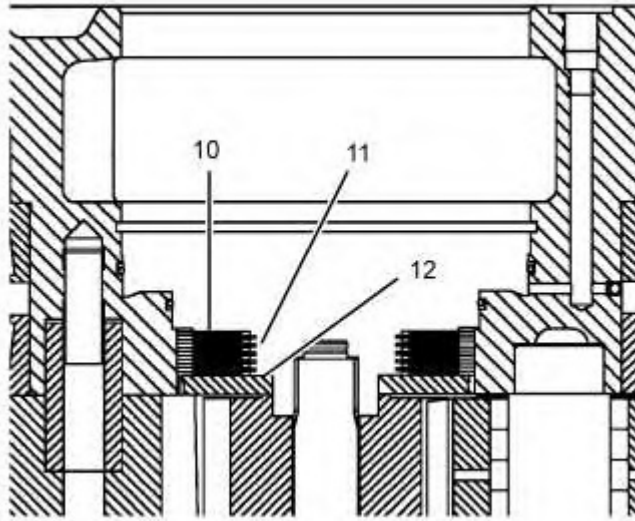

Illustration 17

g01416193

24. Apply clean hydraulic oil to friction discs (10) and discs (11). Install shims (12), if equipped. Install friction discs (10) and discs (11).

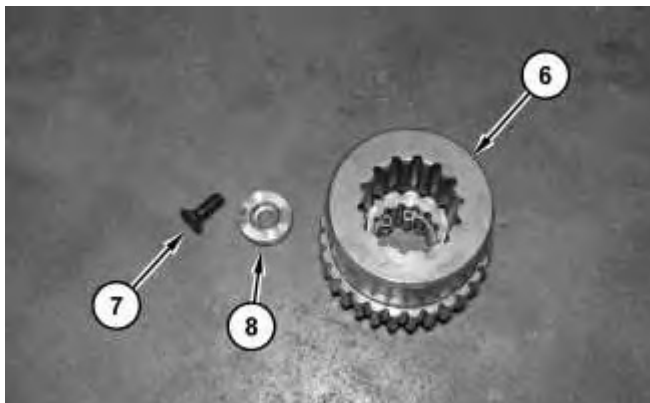

Illustration 18

g01416205

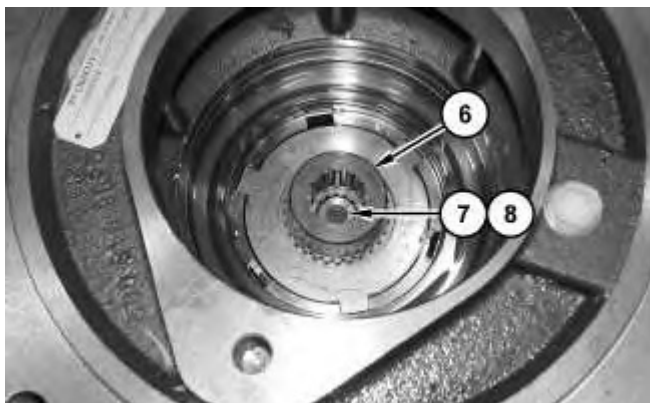

Illustration 19

g01416183

25. Install coupling (6). Install washer (8) and bolt (7) if equipped.

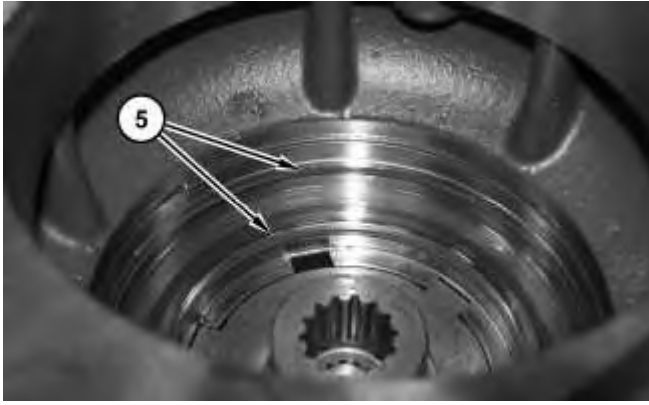

Illustration 20

g01416187

26. Install O-ring seals (5).



Illustration 21

g01416182

27. Use two bolts and install brake piston (4) in the hub.

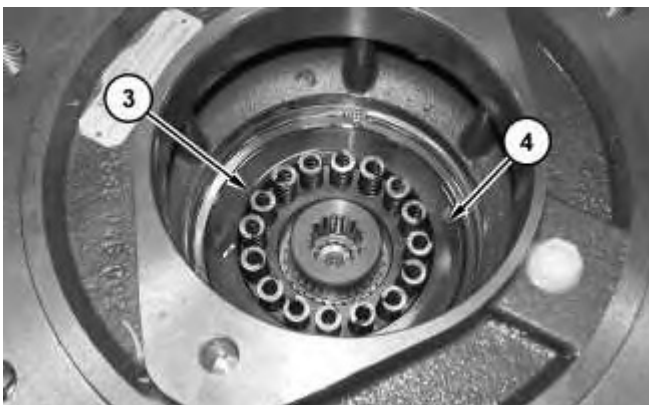

Illustration 22

g01415998

28. Install springs (3) on brake piston (4).

Thank you so much for reading.
Please click the “Buy Now!”
button below to download the
complete manual.



After you pay.

You can download the most
perfect and complete manual in
the world immediately.

Our support email:

ebooklibonline@outlook.com