

Product: VIBRATORY COMPACTOR

Model: CS-78B VIBRATORY COMPACTOR M8M

Configuration: CS74B, CP74B, and CS78B Compactor-Vibratory Soil M8M00001-UP (MACHINE) POWERED BY C6.6 Engine

Disassembly and Assembly

CP74B, CS74B, CP76B, CS76B, CS78B and CS79B Vibratory Soil Compactors Machine Systems

Media Number -UENR0166-10

Publication Date -01/01/2015

Date Updated -01/10/2018

i06668685

Piston Pump (Propel) - Disassemble

SMCS - 5070-015

Disassembly Procedure

Table 1

Required Tools			
Tool	Part Number	Part Description	Qty
A	9U-7289	Ruler	1
B	1P-0510	Driver Gp	1
C	1U-7600	Slide Hammer Puller Gp	1
D	8H-0663	Bearing Puller Gp	1

Start By:

- a. Remove the piston pump (propel).

Note: The following procedure is intended for cleaning purposes only.

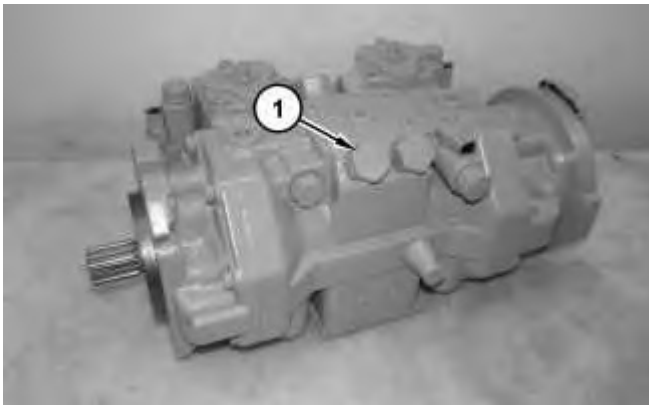

Illustration 1

g03643661

 **WARNING**

Personal injury can result from being struck by parts propelled by a released spring force.

Make sure to wear all necessary protective equipment.

Follow the recommended procedure and use all recommended tooling to release the spring force.

1. Remove cover (1) and the spring for the crossover relief valve.

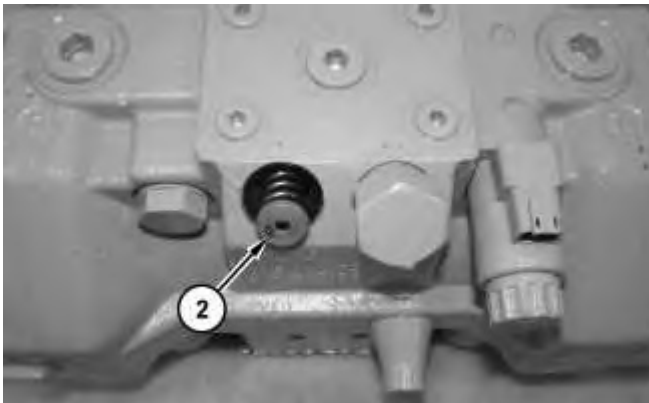

Illustration 2

g03643670

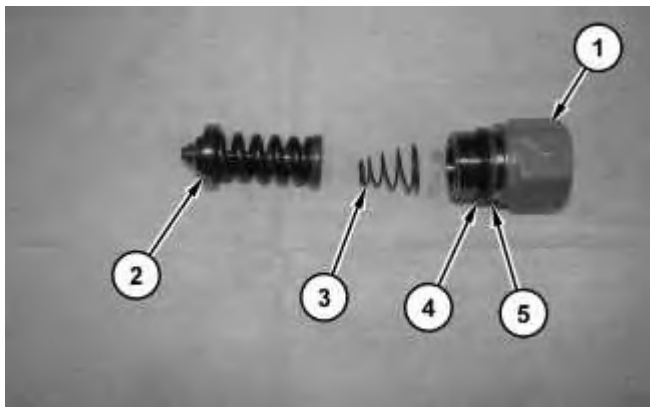

Illustration 3

g03643663

2. Remove seat (2).
3. Note the orientation of spring (3).
4. Remove O-ring seal (4) from cover (1).
5. Remove backup ring (5) from cover (1).
6. Repeat Step 1 through Step 5 for the other covers.



Illustration 4

g03643697

WARNING

Personal injury can result from being struck by parts propelled by a released spring force.

Make sure to wear all necessary protective equipment.

Follow the recommended procedure and use all recommended tooling to release the spring force.

7. Remove plug (6) for the charge relief valve.

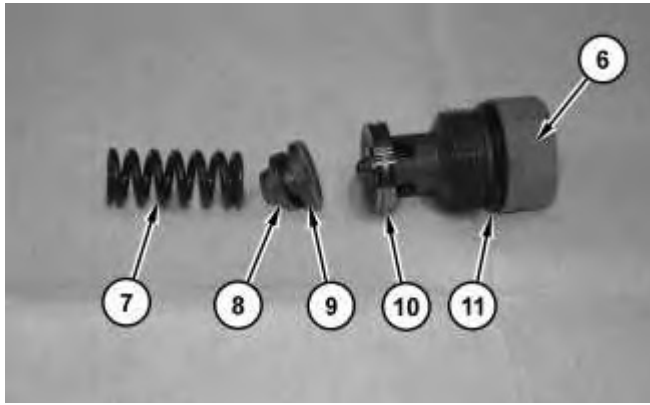

Illustration 5

g03643707

8. Remove seat (9).

9. Remove shims (8).

10. Remove spring (7).

11. Remove seal (10) from plug (6).

12. Remove O-ring seal (11) from plug (6).



Illustration 6

g03643744

13. Remove nut (12).

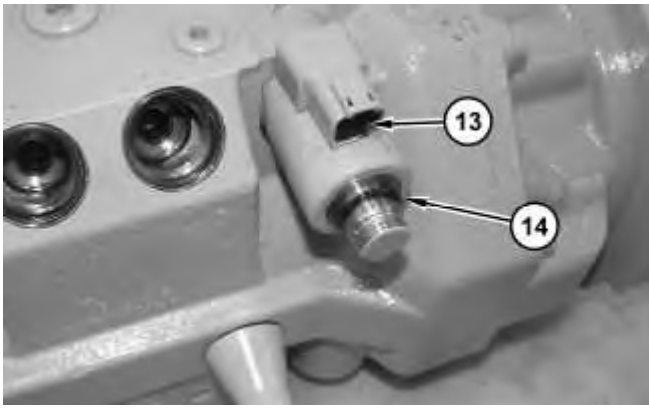

Illustration 7

g03643823

14. Remove O-ring seal (14) and coil assembly (13).

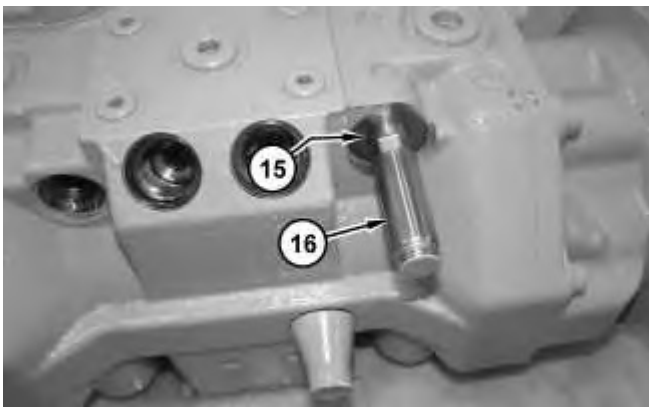

Illustration 8

g03643756

15. Remove cartridge (16) and O-ring seal (15).

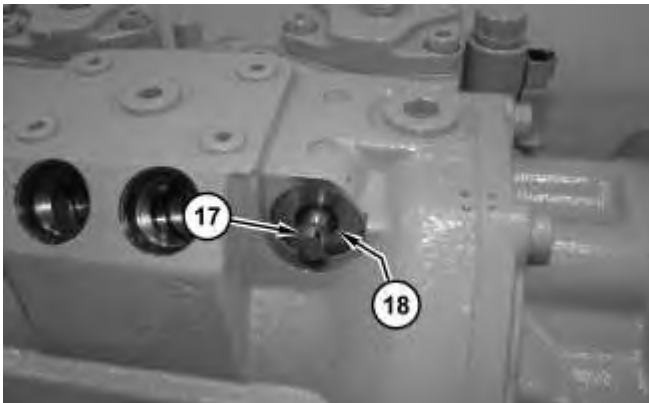

Illustration 9

g03643837

16. Remove spool (17) and spring (18).

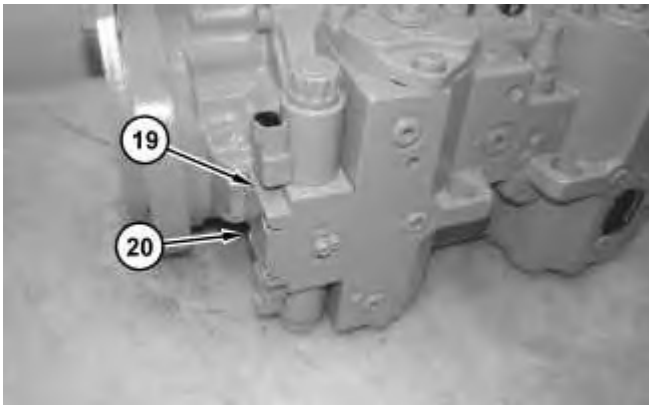

Illustration 10

g03643856

17. Remove bolts (20) and valve assembly (19).

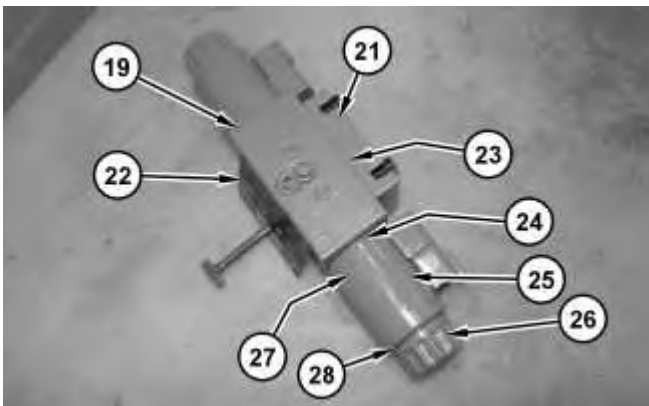

Illustration 11

g03643863

18. Remove plate (21). Remove gasket (23) and gasket (22).
19. Remove nut (26), O-ring seal (28), and coil assembly (25).
20. Remove cartridge (27) and O-ring seal (24).
21. Repeat Step 19 to Step 20 on other side of valve assembly (19).

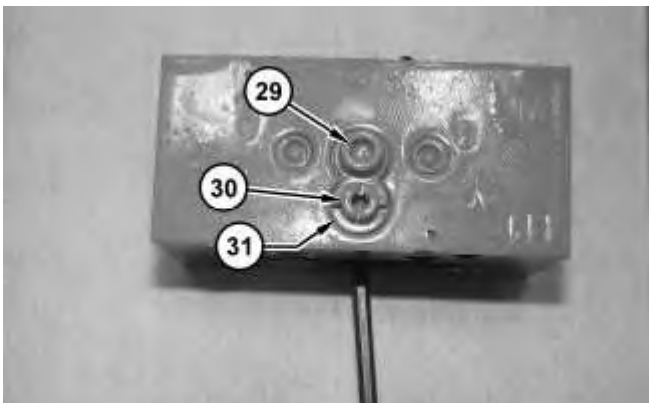

Illustration 12

g03643895

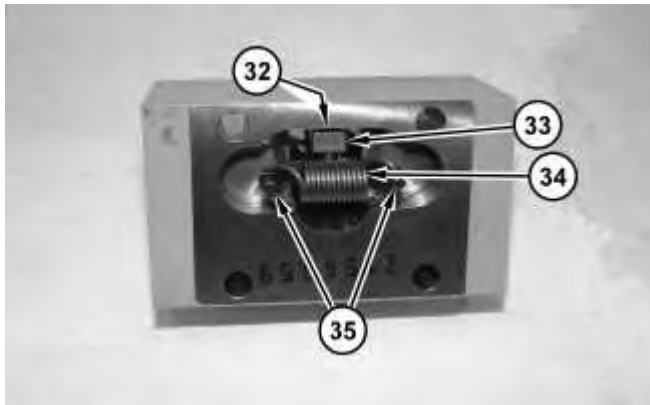

Illustration 13

g03643896

WARNING

Personal injury can result from being struck by parts propelled by a released spring force.

Make sure to wear all necessary protective equipment.

Follow the recommended procedure and use all recommended tooling to release the spring force.

22. Remove bolt (29). Remove eccentric pin (30) and O-ring seal (31).
23. Remove levers (35), draw spring (34), feedback lever (33), and shims (32).
24. Repeat Step 17 to Step 23 on the other side of the piston pump.

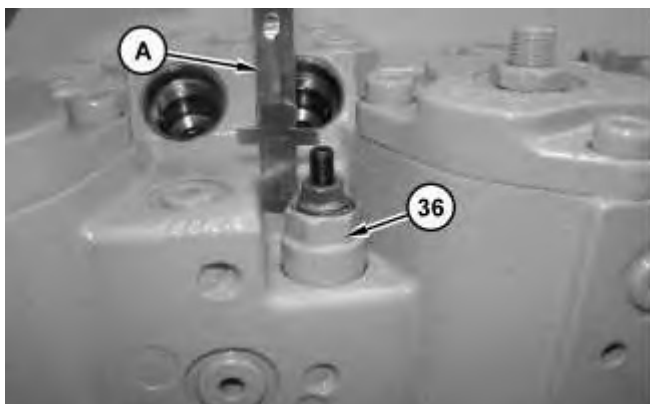

Illustration 14

g03644388

WARNING

Personal injury can result from being struck by parts propelled by a released spring force.

Make sure to wear all necessary protective equipment.

Follow the recommended procedure and use all recommended tooling to release the spring force.

25. Use Tooling (A) to measure the distance from the stud to the nut. Record the distance for assembly purposes.
26. Remove relief valve (36) and the O-ring seal.

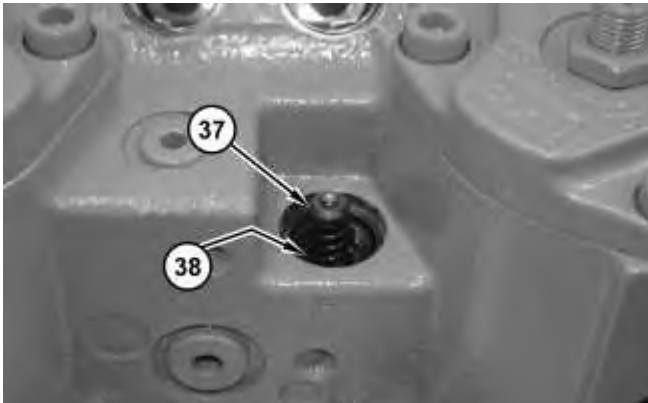

Illustration 15

g03644918

27. Remove spring assembly (37) and spool assembly (38).

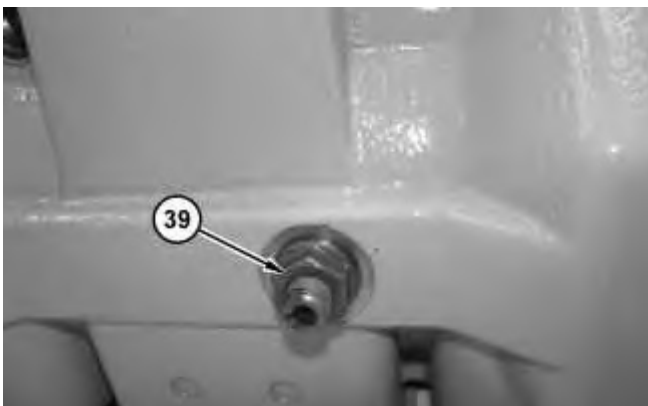

Illustration 16

g03644973

28. Use Tooling (A) to measure the distance from the stud to the nut. Record the distance for assembly purposes. Remove eccentric screw assembly (39).
-

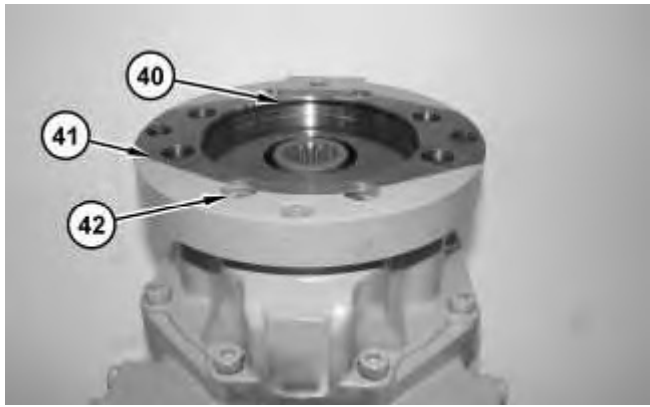

Illustration 17

g03644990

29. Remove O-ring seal (40), bolts (42) and plate (41).

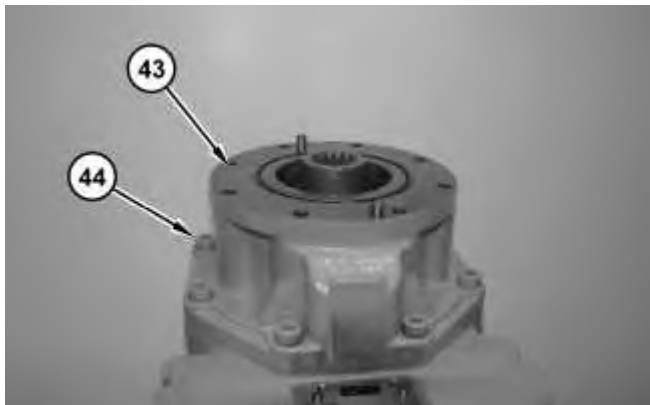

Illustration 18

g03644999

30. Remove bolts (44) and cover assembly (43).

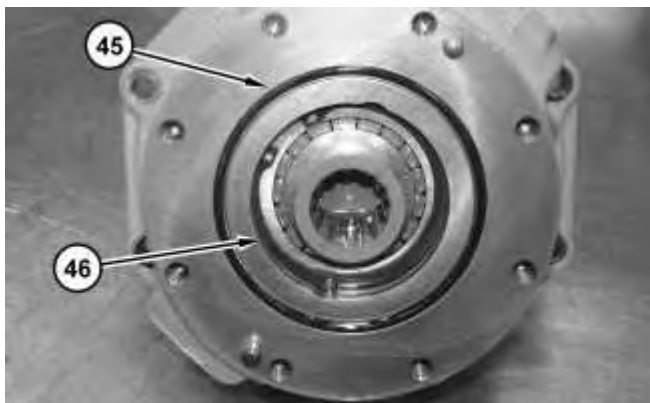

Illustration 19

g03645000

31. Remove O-ring seal (45) and retaining ring (46).

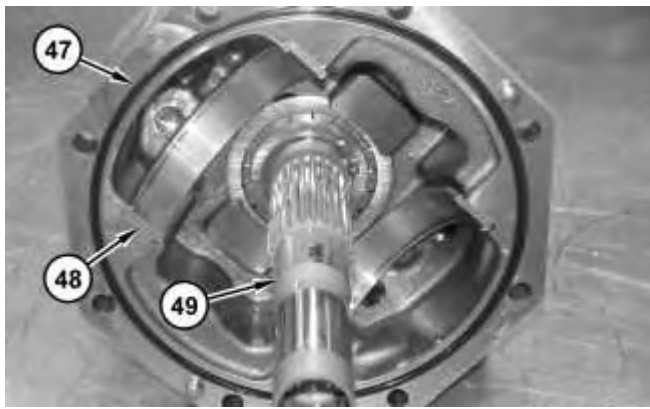

Illustration 20

g03645005

32. Remove O-ring seal (47) and bearing races (48). Remove shaft assembly (49).



Illustration 21

g03645013

33. Remove retaining ring (51). Use suitable press to remove bearing (52) from shaft (50).

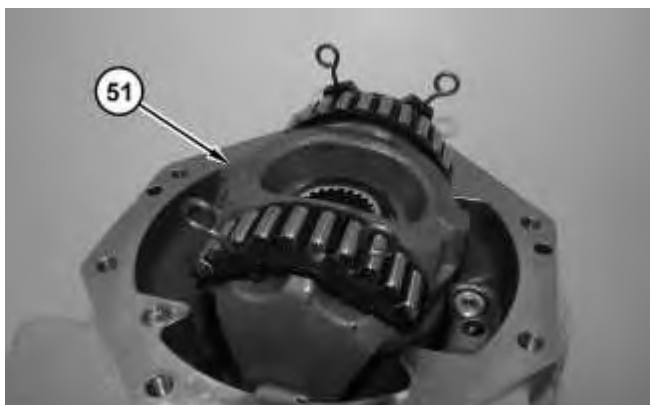

Illustration 22

g03645047

34. Remove rotating assembly (51).

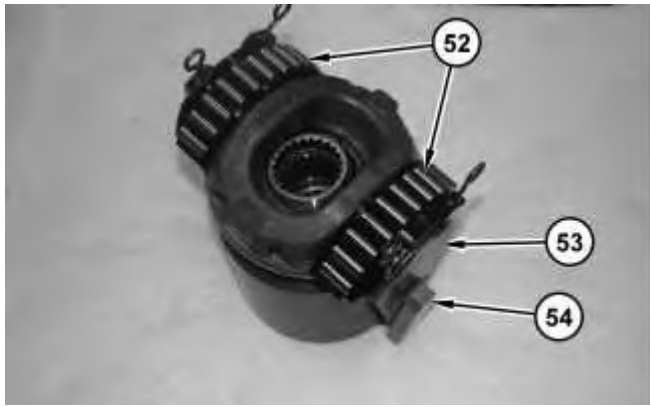

Illustration 23

g03645053

35. Remove bearing assemblies (52), linkage (54), and swashplate (53).

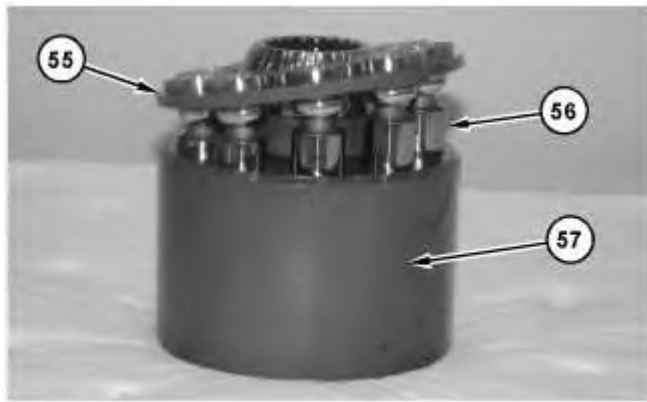

Illustration 24

g06066294

36. Remove reaction plate assembly (55) and pistons (56) from barrel (57).

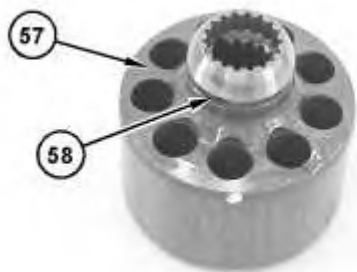

Illustration 25

g06066296

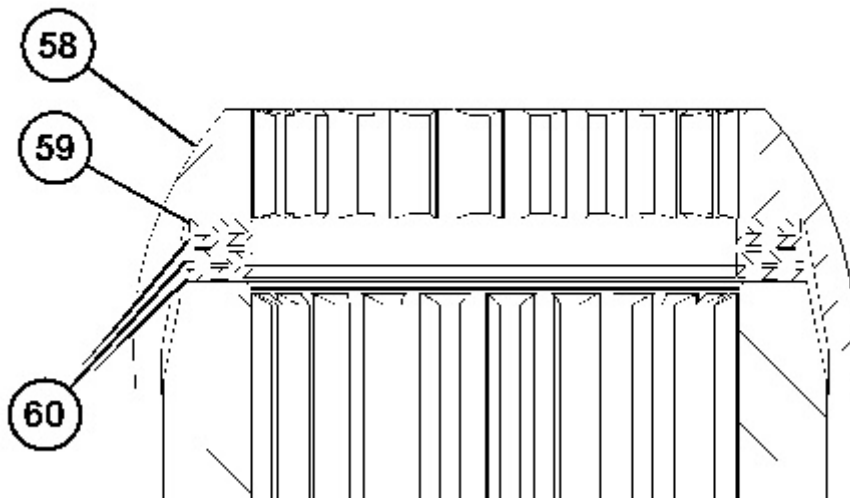

Illustration 26

g06066297

37. Remove bearing (58), shim (59), and spring washers (60) from barrel (57).

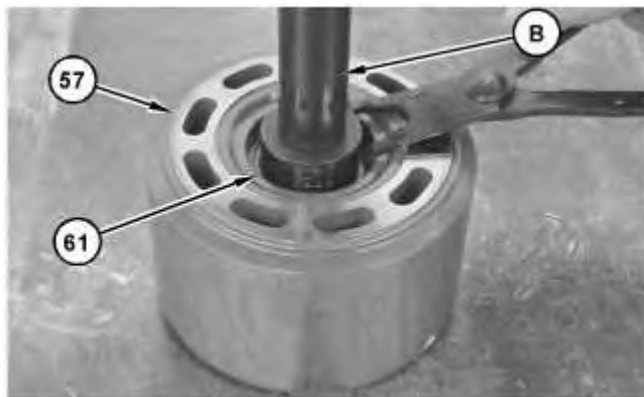

Illustration 27

g06066298



WARNING

Personal injury can result from being struck by parts propelled by a released spring force.

Make sure to wear all necessary protective equipment.

Follow the recommended procedure and use all recommended tooling to release the spring force.

38. Place barrel (57) into a suitable press.

39. Use Tooling (B) to remove retaining ring (61).



Illustration 28

g03645108

40. Remove port plate (62).

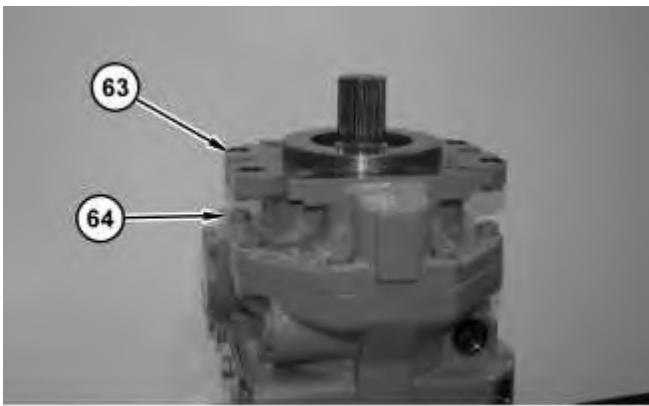

Illustration 29

g03645093

41. Remove bolts (64). Remove housing assembly (63) and the O-ring seal.

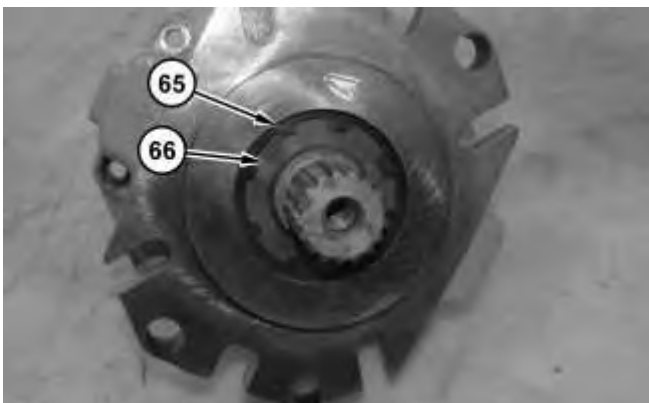

Illustration 30

g03645119

42. Remove retaining ring (65). Use Tooling (C) to remove seal (66).

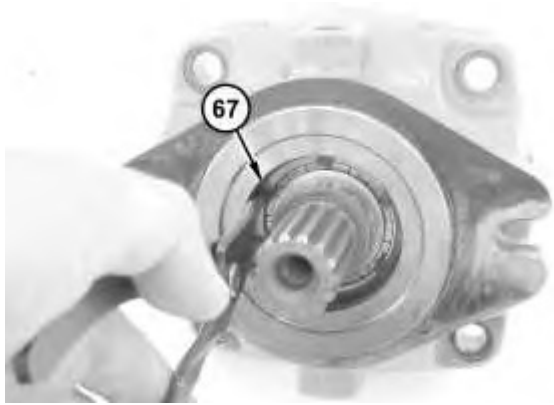

Illustration 31

g03645170

Typical example.

43. Remove retaining ring (67).



Illustration 32

g03645199

Typical example.

44. Remove bearing races (68) and shaft assembly (69).



Illustration 33

g03645173

Typical example.

45. Remove retaining ring (70).

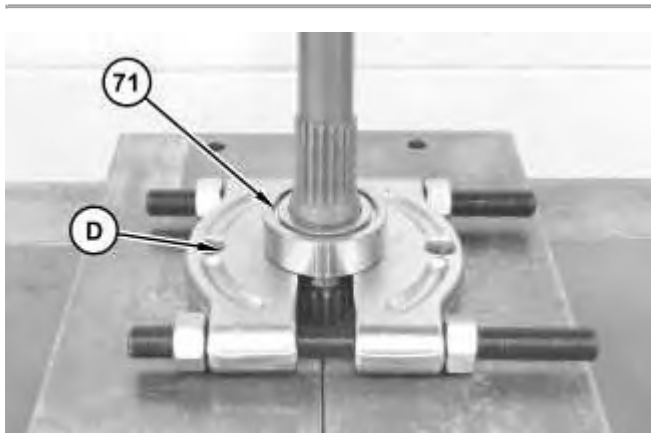

Illustration 34

g03645188

Typical example.

46. Use suitable press and Tooling (D) to remove bearing (71).

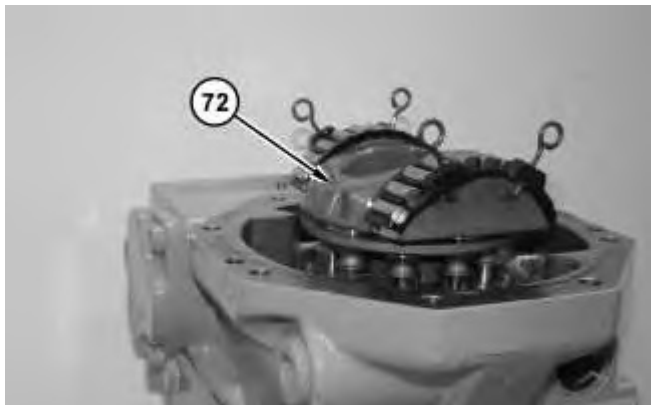

Illustration 35

g03645194

47. Repeat Step 34 through Step 40 to remove rotating group (72).

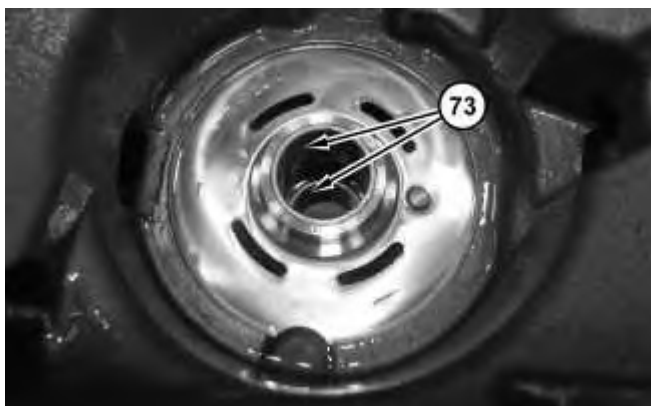

Illustration 36

g03645231

48. Use Tooling (B) to remove bushings (73).
-

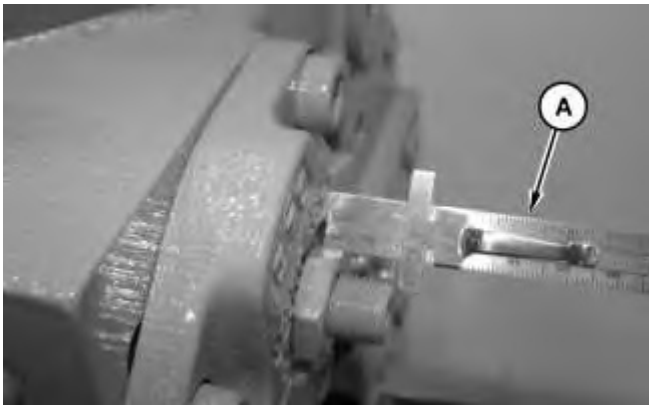

Illustration 37

g03645229

49. Use Tooling (A) to measure the distance from the stud to the nut. Record the distance for assembly purposes.

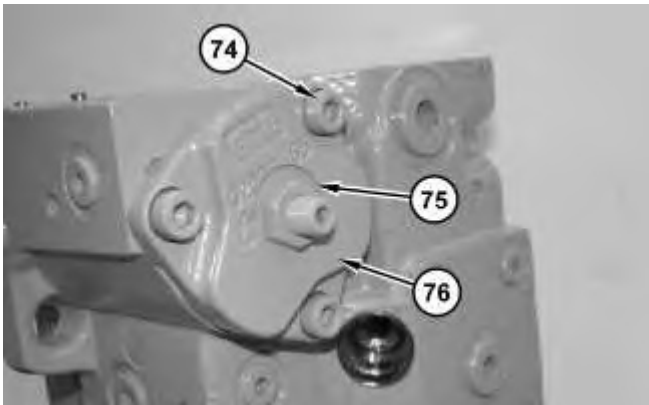

Illustration 38

g03645246

50. Remove bolts (74).
51. Remove nut (75).
52. Remove cover (76).



Illustration 39

g03645645

53. Remove O-ring seal (77) from cover (76).

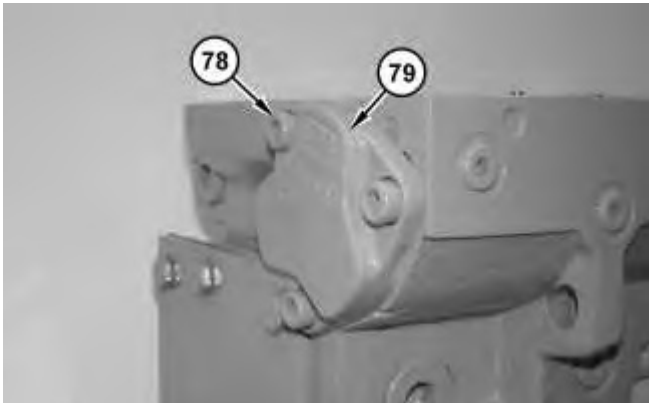

Illustration 40

g03645251

54. Remove bolts (78) and cover (79).



Illustration 41

g03645257

55. Remove O-ring seal (80) from cover (79).

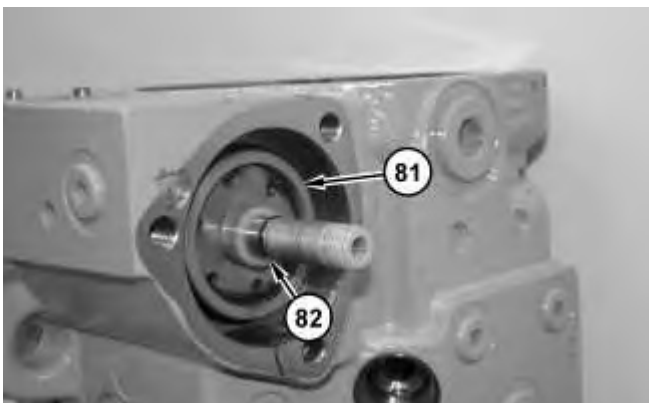

Illustration 42

g03645261

56. Remove actuator assembly (81) and O-ring seal (82).

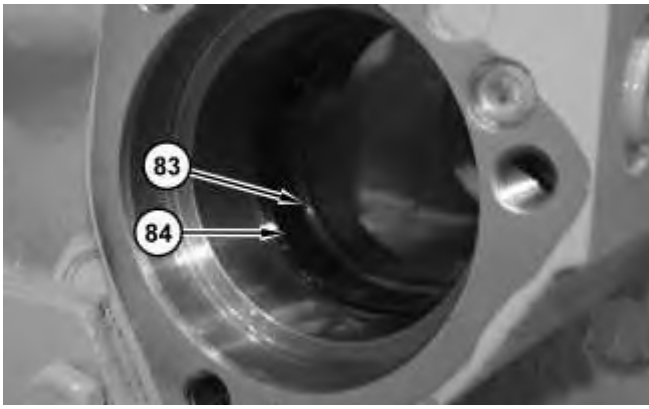

Illustration 43

g03645291

57. Remove seals (83).
 58. Remove liner (84).
 59. Repeat Step 49 through Step 58 for the other end of the piston pump.
-

Product: VIBRATORY COMPACTOR

Model: CS-78B VIBRATORY COMPACTOR M8M

Configuration: CS74B, CP74B, and CS78B Compactor-Vibratory Soil M8M00001-UP (MACHINE) POWERED BY C6.6 Engine

Disassembly and Assembly

CP74B, CS74B, CP76B, CS76B, CS78B and CS79B Vibratory Soil Compactors Machine Systems

Media Number -UENR0166-10

Publication Date -01/01/2015

Date Updated -01/10/2018

i06674297

Piston Pump (Propel) - Assemble

SMCS - 5070-016

Assembly Procedure

Table 1

Required Tools			
Tool	Part Number	Part Description	Qty
A	9U-7289	Scale	1
B	1P-0510	Driver Gp	1
D	8H-0663	Bearing Puller Gp	1
E	6V-2055	Grease	1
F	1U-6395	Grease	1
G	2P-8301	Seal Guide	1
H	135-8296	Test Ring	1

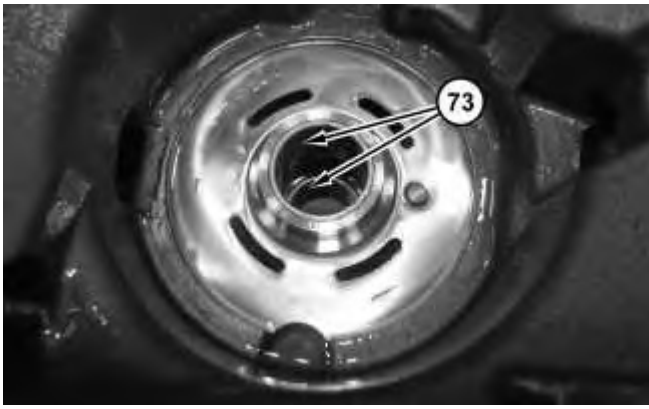

Illustration 1

g03645231

1. Use Tooling (B) to install bushings (73).

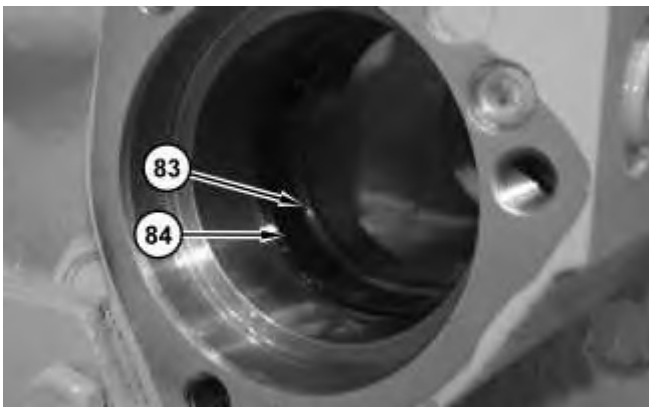

Illustration 2

g03645291

2. Install liner (84).
3. Install seal (83).

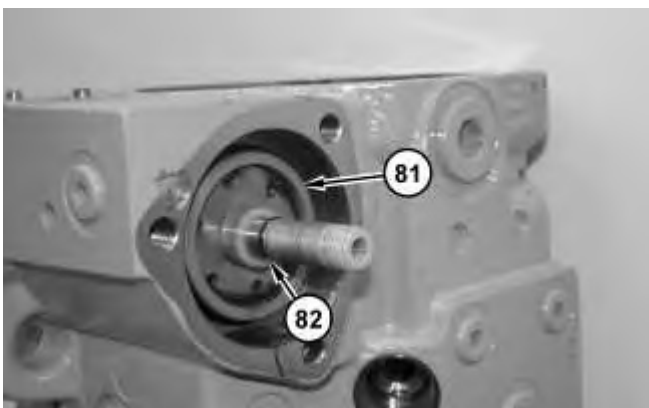

Illustration 3

g03645261

4. Install O-ring seal (82). Install actuator assembly (81).



Illustration 4

g03645257

5. Install O-ring seal (80) to cover (79).

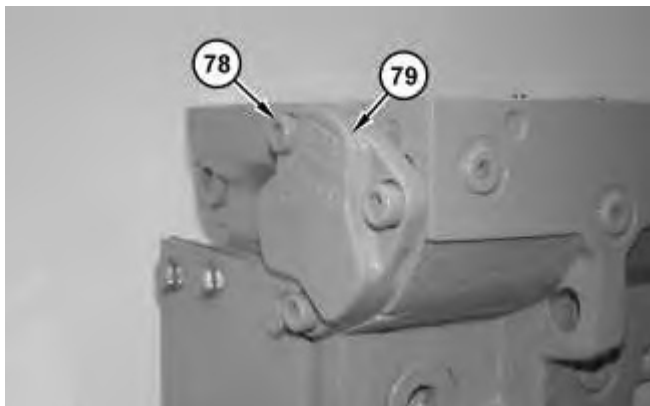

Illustration 5

g03645251

6. Install cover (79) and bolts (78).



Illustration 6

g03645645

7. Install O-ring seal (77) to cover (76).
-

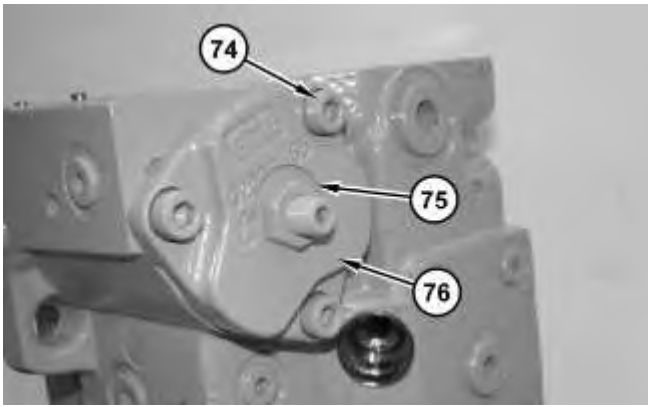

Illustration 7

g03645246



Illustration 8

g03645229

8. Install cover (76), nut (75), and bolts (74). Use Tooling (A) to measure the distance from the stud to nut (75). Set the distance to the recorded measurement from the disassembly.
9. Repeat Step 2 through Step 8 for the other end of the piston pump.



Illustration 9

g03645108

10. Install port plate (62).

Thank you so much for reading.
Please click the “Buy Now!”
button below to download the
complete manual.



After you pay.

You can download the most
perfect and complete manual in
the world immediately.

Our support email:

ebooklibonline@outlook.com