

Product: TRACK-TYPE TRACTOR
Model: D4D TRACK-TYPE TRACTOR 07R
Configuration: D4D LGP TRACTOR 07R00508-00758 (MACHINE)

Disassembly and Assembly 54 TOWING WINCH

Media Number -SEN7363-00

Publication Date -01/03/1976

Date Updated -12/10/2001

Pump

SMCS - 5164-11; 5164-12; 5164-15; 5164-16

Remove Pump



1. Disconnect the two oil lines from pump (2).
2. Remove two bolts (1) and remove pump (2).
3. Remove the O-ring seal from the pump.

Install Pump

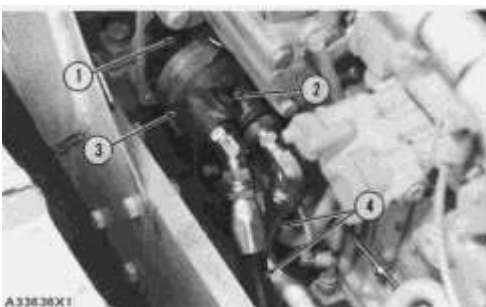

1. Install a new O-ring seal on pump (3).
2. Put pump (3) in position on the machine and install two bolts (1).
3. Connect oil lines (4) to pump (3).

4. Remove plug (2) from the pump. Fill the pump with the same oil that is used in the winch. Use the starting motor to turn the tractor engine (do not start the engine) until a constant stream of oil flows from the open port in the pump. Install plug (2). Start the tractor engine and run it at low idle. Operate the winch in all control positions. Stop the engine. Check the oil level in the winch and add oil as necessary.

NOTICE

The above procedure must be used to prevent damage to the winch oil pump. Never run the tractor engine or operate the winch until the air has been removed from the winch oil pump and lines.

Disassemble Pump

Tools Needed		A	B
8B7548	Puller Assembly	1	
8H684	Ratchet Box Wrench	1	
8B7550	Leg	2	
5H9976	Screw	1	
8H663	Bearing Pulling Attachment	1	
5F7465	Puller		1
9S9152	Bearing Pulling Attachment		1
1P465	Drive Plate		1

start by:

a) remove hydraulic pump

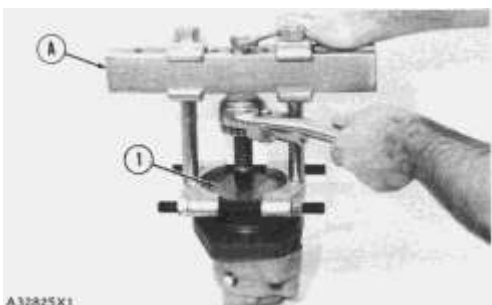

1. Remove the ring that holds gear (1) in position on the shaft.
2. Remove gear (1) and the bearing with tooling (A).

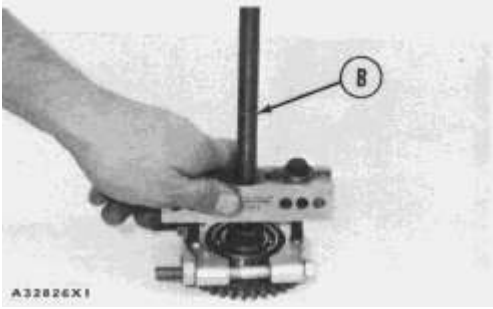

3. Remove the bearing from the gear with tooling (B).



4. Remove the bolts and remove adapter (2).

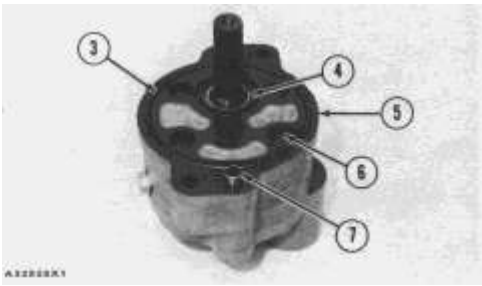

5. Remove O-ring seal (3) and remove bolts (6).

6. Remove cover assembly (5) and remove seal (4) from the cover assembly.

7. If necessary remove two dowels (7) and the two bearings from cover assembly (5).

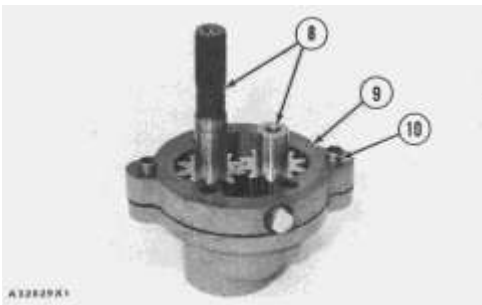

8. Remove gear assemblies (8) and body assembly (9).

9. If necessary, remove dowels (10) from body assembly (9).

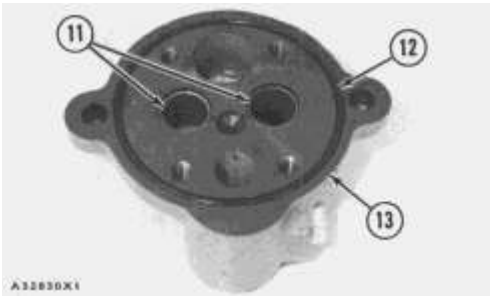

10. Remove O-ring seal (12) and bearings (11) from manifold assembly (13).

Assemble Pump

Tools Needed		A	B
1P529	Handle	1	1
1P460	Drive Plate	1	1
1P463	Drive Plate	1	
1P470	Drive Plate		1

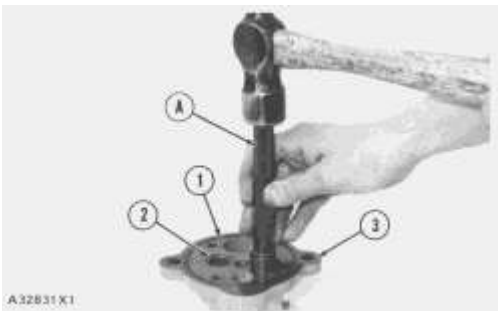

1. Install a new O-ring seal (1) in manifold assembly (3).

2. With tooling (A), install two bearings (2) in manifold assembly (3) to a depth of .062 in. (1.57 mm).

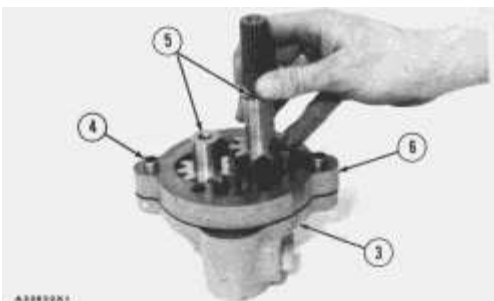

3. If necessary, install new dowels (4) in body assembly (6) with .25 in. (6.35 mm) of dowels extended through each surface of the body assembly.

4. Put body assembly (6) in position on the manifold assembly (3).

5. Install the gear assemblies (5) in manifold assembly (3).

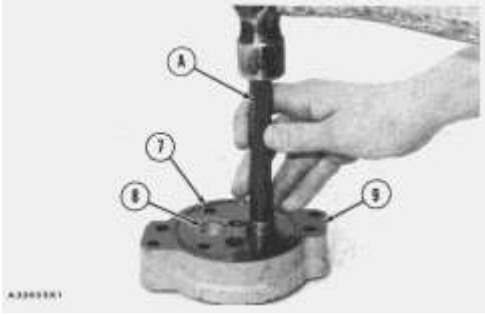

6. Install new O-ring seal (7) in cover assembly (9).

7. With tooling (A) install two bearings (8) in cover assembly (9) to a depth of .062 in. (1.57 mm).

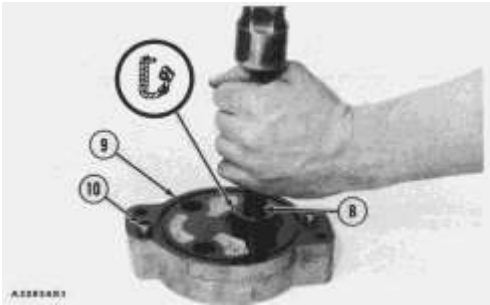

8. If necessary install new dowels (10) with .25 in. (6.35 mm) of dowels extended above the surface of cover assembly (9).

9. Install the seal in cover assembly (9) with tooling (B) with the lip of the seal toward the inside of the pump.

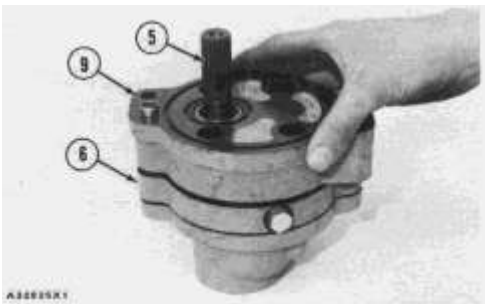

10. Install cover assembly (9) on body assembly (6) and tighten the bolts.

NOTICE

Gear assemblies (5) must turn freely by hand after the bolts are tightened.

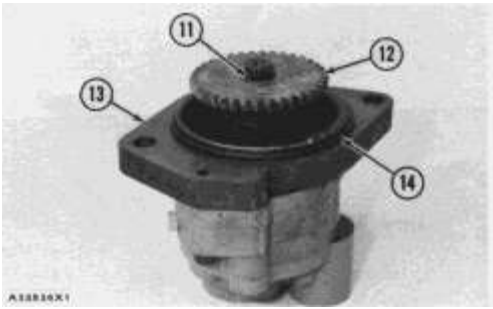

11. Install a new O-ring seal in the cover assembly.

12. Install adapter (13) and tighten the two bolts.

13. Install the bearing on gear (12) and install the gear.

14. Install ring (11) and put new O-ring seal (14) on the pump assembly.

end by:

a) install hydraulic pump

Product: TRACK-TYPE TRACTOR
Model: D4D TRACK-TYPE TRACTOR 07R
Configuration: D4D LGP TRACTOR 07R00508-00758 (MACHINE)

Disassembly and Assembly 54 TOWING WINCH

Media Number -SEN7363-00

Publication Date -01/03/1976

Date Updated -12/10/2001

Control Valve

SMCS - 5170-16; 5170-11; 5170-12; 5170-15

Remove Control Valve

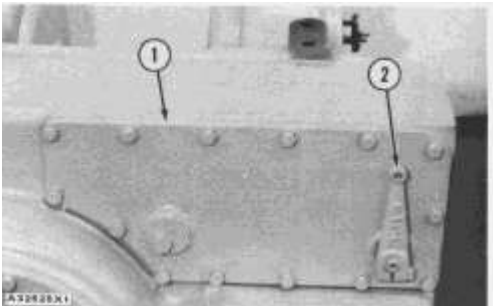

1. Loosen the bolt and remove lever (2).
2. Remove cover assembly (1).

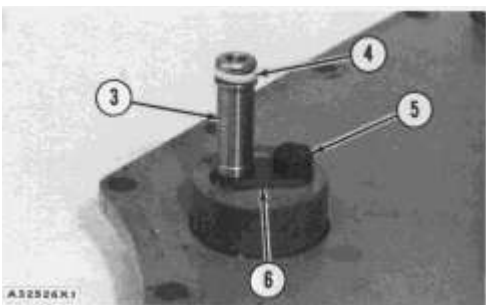

3. Remove bolt (5) and clip (6).
4. Remove sleeve (3). Remove two O-ring seals (4) from sleeve (3).
5. Remove the seal and the bearing from cover assembly (1).

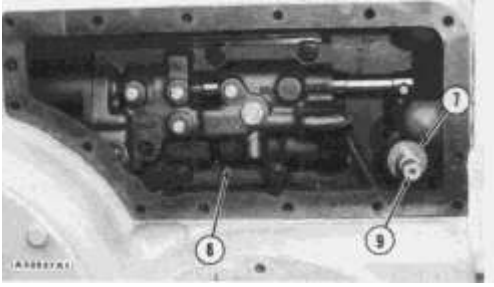

6. Remove washer (7).

7. Remove the bolts and remove control valve (8).

8. Remove shaft and lever assembly (9). Hold washer on back of shaft (9) so it will not drop in case.



9. Fill the bearing in the case assembly with grease and use a .75 in. (19.05 mm) diameter shaft to force the bearing from the case assembly.

10. Remove six O-ring seals (10).

Install Control Valve

Tools Needed		A
1P529	Handle	1
1P459	Drive Plate	1
1P470	Drive Plate	1

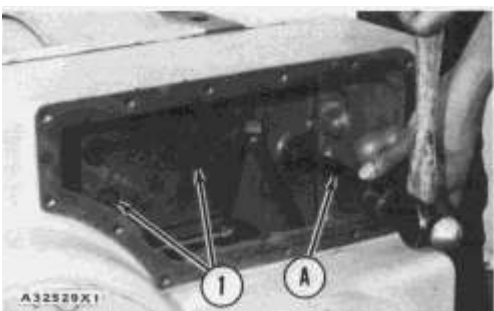

1. Install new O-ring seals (1) in the manifold.

2. Use tooling (A) and install the bearing in the case assembly.



3. Install the washer on back of shaft (3) and install shaft (3).
4. Install control valve (2) and tighten bolts.

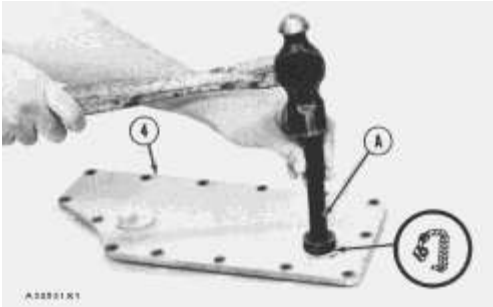

5. Put 7M7260 Liquid Gasket material in bore of cover assembly (4). Use tooling (A) and install the seal in cover assembly (4) with lip of seal toward inside.
6. Use tooling (A) and install the bearing in cover (4).

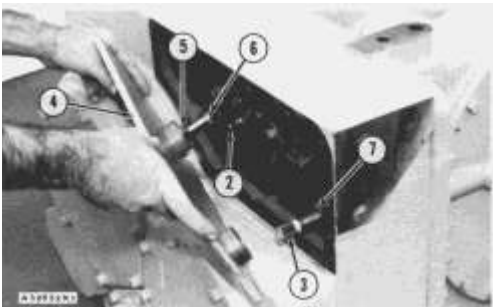

7. Install new O-ring seals on sleeve (6). Install sleeve (6) in cover (4). Install the clip on sleeve (6) and tighten bolt (5).
8. Install washer (7) on shaft (3).
9. Install a new gasket and install cover assembly (4). Make sure sleeve (6) goes in bore of control valve (2) and shaft (3) is free to move.
10. Tighten bolts and install the control lever.

Disassemble Control Valve

start by:

- a) remove control valve



1. Remove cover (1).

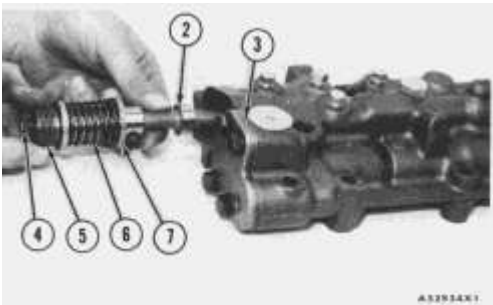

2. Remove valve spool (2).

3. Remove bolt (4) and the two washers from valve spool (2).

4. Remove spring (5) and the spacer from valve spool (2).

5. Remove the two washers, spring (6) the sleeve and washer (7) from valve spool (2).

6. Remove cover (3).

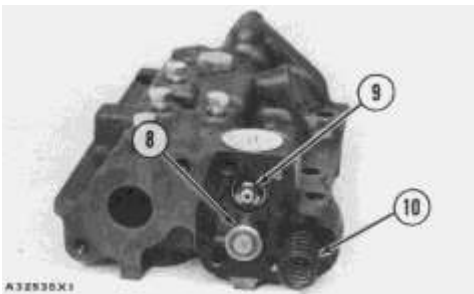

7. Remove valve spool (8) and the shims.

8. Remove spring (10) and the plunger.

9. Remove valve assembly (9).

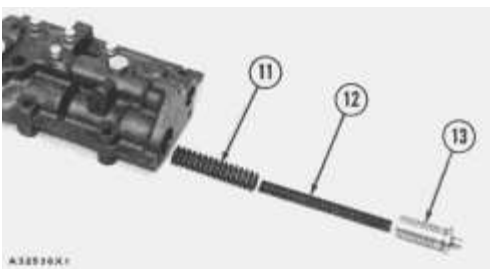

10. Remove the cover and remove piston (13), spring (12) and spring (11).

Assemble Control Valve

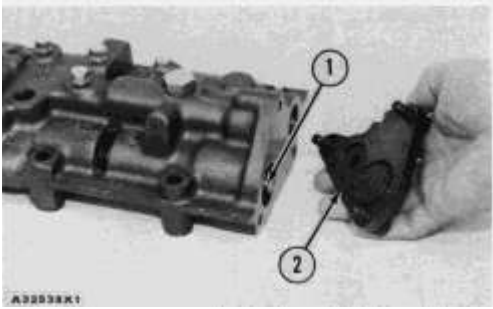

1. Install the two springs and piston (1) in the control valve body.

2. Install a new O-ring seal in cover (2) and install cover (2) on the control valve body. Tighten bolts to 22 ± 3 lb. ft. (30 ± 4 N·m).

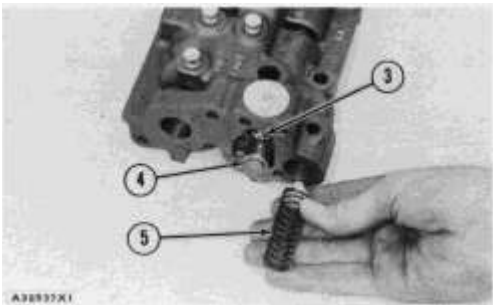

3. Install the shims and valve spool (4) in the control valve body.

4. Install valve assembly (3).

5. Install the plunger and spring (5). Install the cover. Tighten bolts to 22 ± 3 lb. ft. (30 ± 4 N·m).

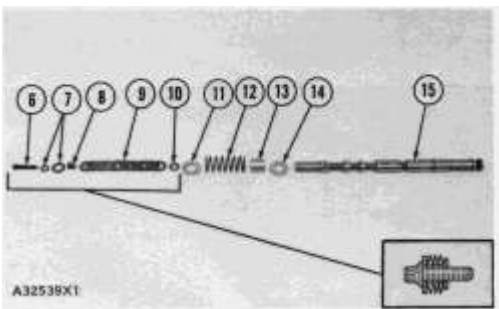

6. Starting with the smaller washer, install washers (7) on bolt (6).

7. Install spacer (8) on bolt (6).

8. Install spring washers (9) and washer (10) on bolt (6) with the outer edges of the spring washers in contact with each other.

9. Install washer (14), sleeve (13), spring (12) and washer (11) on valve spool (15).

10. Install bolt (6) in valve spool (15).

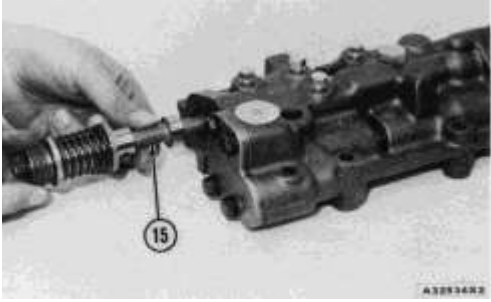

11. Install valve spool (15) and the cover on the control valve body. Tighten bolts to 22 ± 3 lb. ft. (30 ± 4 N·m).

end by:

a) install control valve

Product: TRACK-TYPE TRACTOR
Model: D4D TRACK-TYPE TRACTOR 07R
Configuration: D4D LGP TRACTOR 07R00508-00758 (MACHINE)

Disassembly and Assembly 54 TOWING WINCH

Media Number -SEN7363-00

Publication Date -01/03/1976

Date Updated -12/10/2001

Input Gear

SMCS - 5166-16; 5166-11; 5166-12; 5166-15

Remove Input Gear

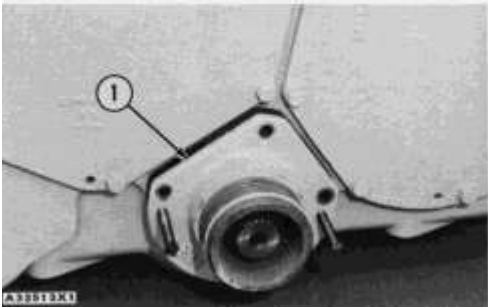

1. Remove the bolts from input shaft cage (1). Remove input gear assembly with two 3/8"-16 NC forcing screws.
2. Remove the O-ring seals from input shaft cage.

Install Input Gear

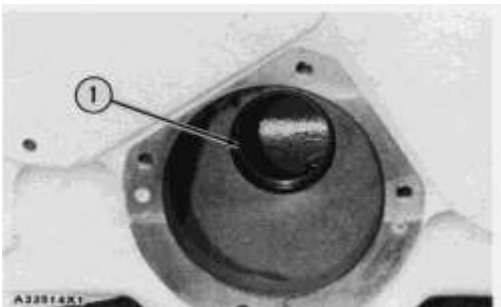

1. Inspect ring (1) in case. Make a replacement if necessary.

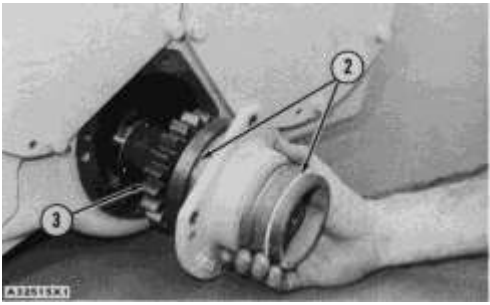

2. Install new O-ring seals (2) on the input gear cage.
3. Install input gear assembly (3) in case.

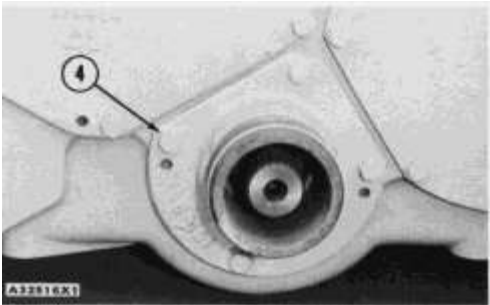

4. Tighten bolts (4).

NOTICE

Be certain that the teeth of the input gear and the input clutch engage correctly before the bolts are tightened to prevent damage.

Disassemble Input Gear

Tools Needed	A	B
8B7548 Puller Assembly	1	1
8B7550 Leg	2	
5H9976 Screw	1	
8H684 Ratchet Box Wrench	1	1
8B7551 Bearing Pulling Attachment	1	
9S9155 Spacer	1	
8H663 Bearing Pulling Attachment		1
8B7560 Step Plate		1

start by:

a) remove input gear

1. Remove the bolt and washer that hold bearing in position.

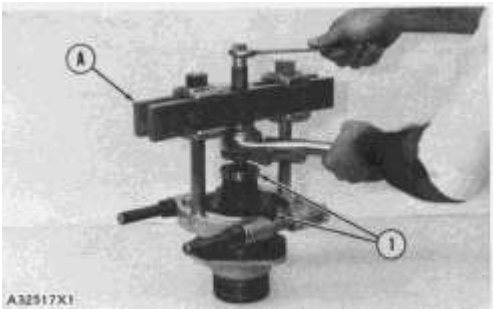

2. Remove gear and bearing (1) as a unit with tooling (A).

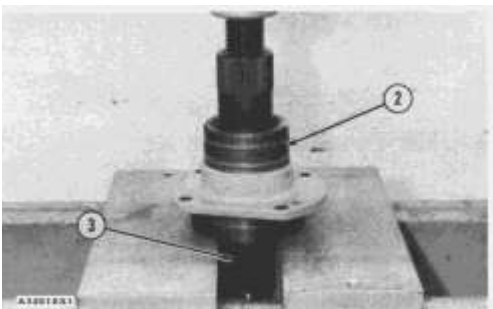

3. Use a press and remove the bearing and shaft (3) from cage (2).

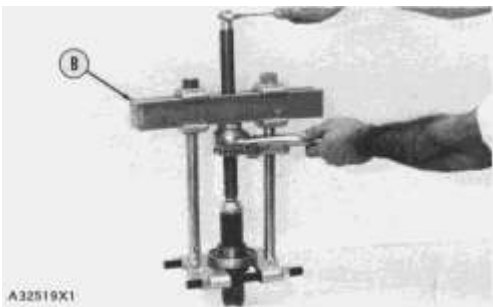

4. Remove the bearing from the shaft with tooling (B).

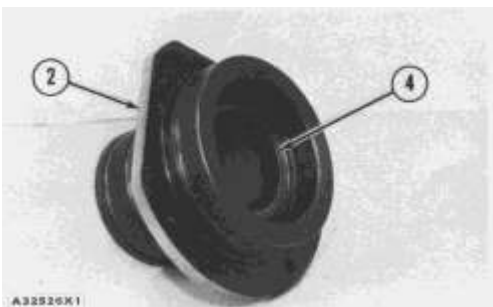

5. Remove seal (4) from cage (2).

Thank you so much for reading.
Please click the “Buy Now!”
button below to download the
complete manual.



After you pay.

You can download the most
perfect and complete manual in
the world immediately.

Our support email:

ebooklibonline@outlook.com