

Product: TRACK-TYPE TRACTOR

Model: D4D TRACK-TYPE TRACTOR 59J

Configuration: D4D TRACTOR / POWER SHIFT / 59J01867-UP (MACHINE) POWERED BY 3304 ENGINE

Disassembly and Assembly 54 TOWING WINCH

Media Number -SEN7363-00

Publication Date -01/03/1976

Date Updated -12/10/2001

Control Valve

SMCS - 5170-11; 5170-12; 5170-15; 5170-16

Remove Control Valve

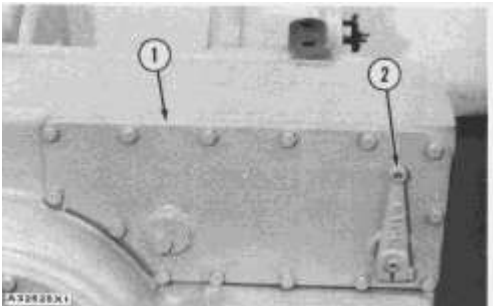

1. Loosen the bolt and remove lever (2).
2. Remove cover assembly (1).

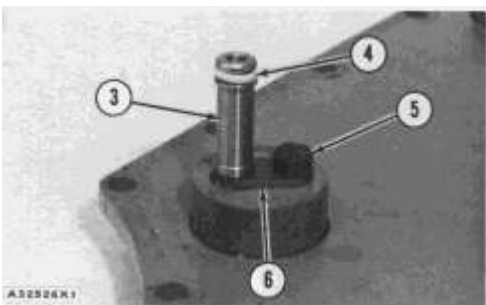

3. Remove bolt (5) and clip (6).
4. Remove sleeve (3). Remove two O-ring seals (4) from sleeve (3).
5. Remove the seal and the bearing from cover assembly (1).

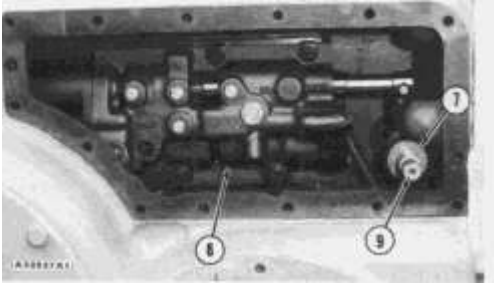

6. Remove washer (7).

7. Remove the bolts and remove control valve (8).

8. Remove shaft and lever assembly (9). Hold washer on back of shaft (9) so it will not drop in case.



9. Fill the bearing in the case assembly with grease and use a .75 in. (19.05 mm) diameter shaft to force the bearing from the case assembly.

10. Remove six O-ring seals (10).

Install Control Valve

Tools Needed		A
1P529	Handle	1
1P459	Drive Plate	1
1P470	Drive Plate	1

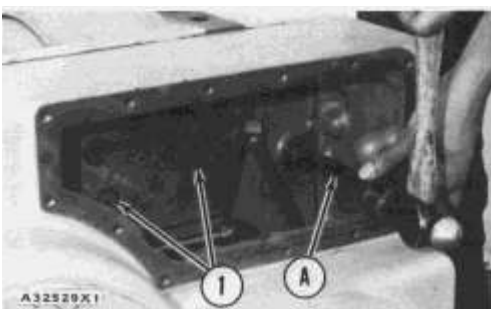

1. Install new O-ring seals (1) in the manifold.

2. Use tooling (A) and install the bearing in the case assembly.



3. Install the washer on back of shaft (3) and install shaft (3).
4. Install control valve (2) and tighten bolts.

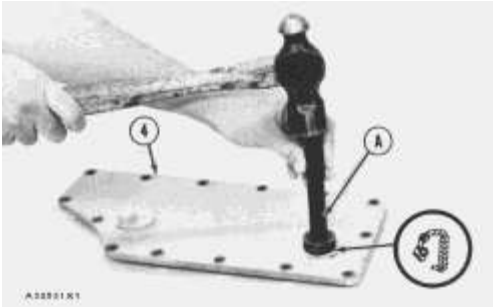

5. Put 7M7260 Liquid Gasket material in bore of cover assembly (4). Use tooling (A) and install the seal in cover assembly (4) with lip of seal toward inside.
6. Use tooling (A) and install the bearing in cover (4).

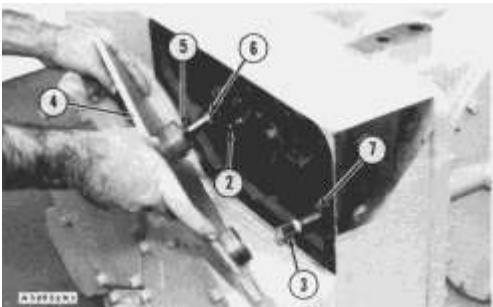

7. Install new O-ring seals on sleeve (6). Install sleeve (6) in cover (4). Install the clip on sleeve (6) and tighten bolt (5).
8. Install washer (7) on shaft (3).
9. Install a new gasket and install cover assembly (4). Make sure sleeve (6) goes in bore of control valve (2) and shaft (3) is free to move.
10. Tighten bolts and install the control lever.

Disassemble Control Valve

start by:

- a) remove control valve



1. Remove cover (1).

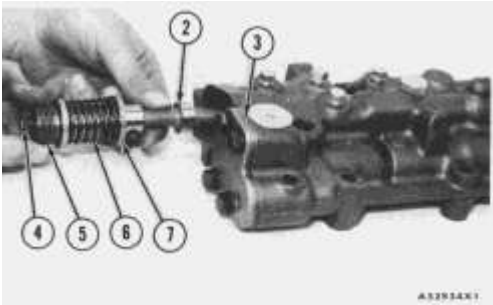

2. Remove valve spool (2).

3. Remove bolt (4) and the two washers from valve spool (2).

4. Remove spring (5) and the spacer from valve spool (2).

5. Remove the two washers, spring (6) the sleeve and washer (7) from valve spool (2).

6. Remove cover (3).

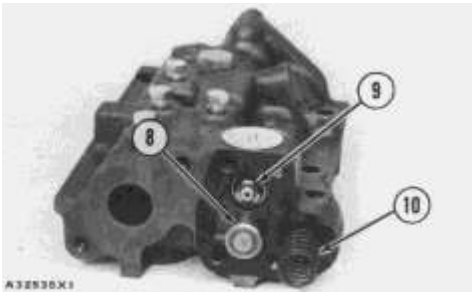

7. Remove valve spool (8) and the shims.

8. Remove spring (10) and the plunger.

9. Remove valve assembly (9).

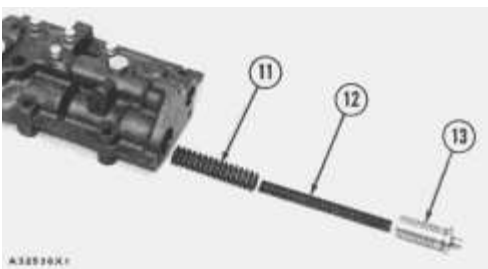

10. Remove the cover and remove piston (13), spring (12) and spring (11).

Assemble Control Valve

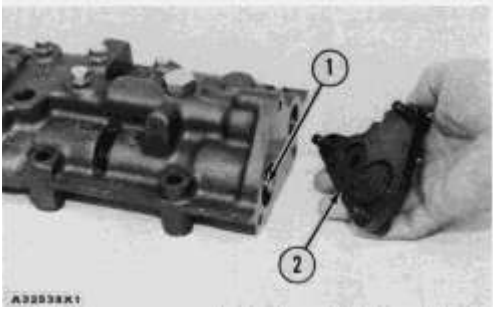

1. Install the two springs and piston (1) in the control valve body.

2. Install a new O-ring seal in cover (2) and install cover (2) on the control valve body. Tighten bolts to 22 ± 3 lb. ft. (30 ± 4 N·m).

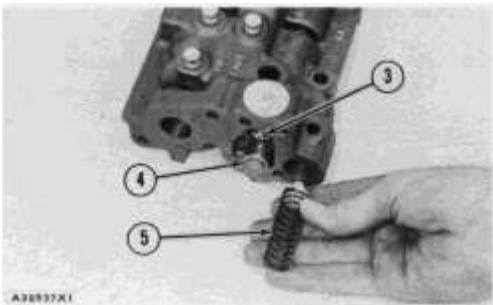

3. Install the shims and valve spool (4) in the control valve body.

4. Install valve assembly (3).

5. Install the plunger and spring (5). Install the cover. Tighten bolts to 22 ± 3 lb. ft. (30 ± 4 N·m).

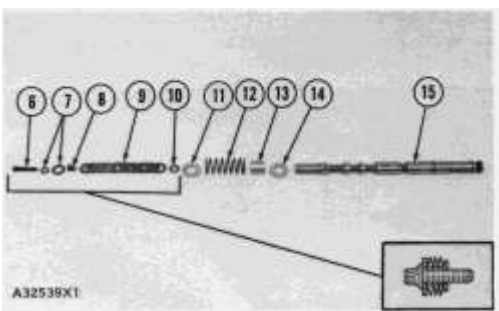

6. Starting with the smaller washer, install washers (7) on bolt (6).

7. Install spacer (8) on bolt (6).

8. Install spring washers (9) and washer (10) on bolt (6) with the outer edges of the spring washers in contact with each other.

9. Install washer (14), sleeve (13), spring (12) and washer (11) on valve spool (15).

10. Install bolt (6) in valve spool (15).

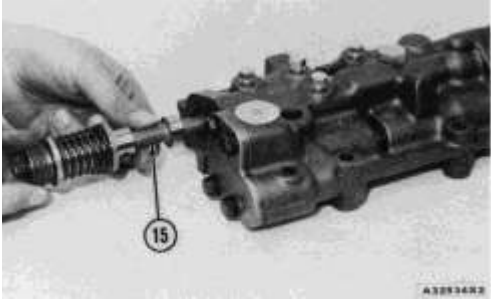

11. Install valve spool (15) and the cover on the control valve body. Tighten bolts to 22 ± 3 lb. ft. (30 ± 4 N·m).

end by:

a) install control valve

Product: TRACK-TYPE TRACTOR

Model: D4D TRACK-TYPE TRACTOR 59J

Configuration: D4D TRACTOR / POWER SHIFT / 59J01867-UP (MACHINE) POWERED BY 3304 ENGINE

Disassembly and Assembly 54 TOWING WINCH

Media Number -SEN7363-00

Publication Date -01/03/1976

Date Updated -12/10/2001

Input Gear

SMCS - 5166-11; 5166-12; 5166-15; 5166-16

Remove Input Gear

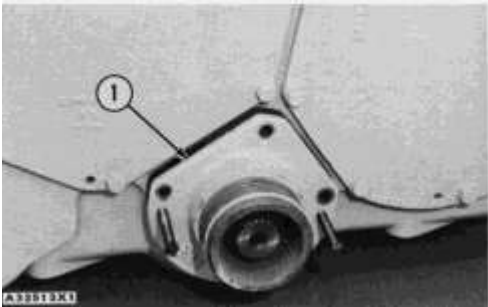

1. Remove the bolts from input shaft cage (1). Remove input gear assembly with two 3/8"-16 NC forcing screws.
2. Remove the O-ring seals from input shaft cage.

Install Input Gear

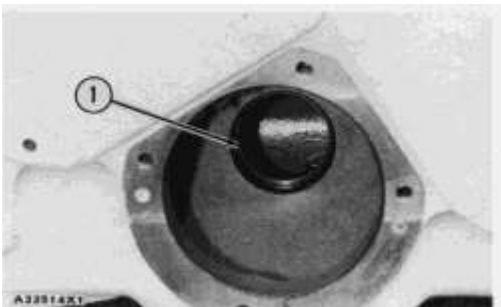

1. Inspect ring (1) in case. Make a replacement if necessary.

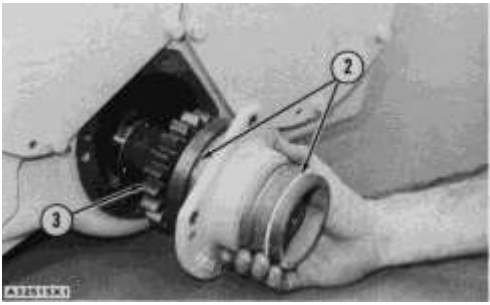

2. Install new O-ring seals (2) on the input gear cage.
3. Install input gear assembly (3) in case.

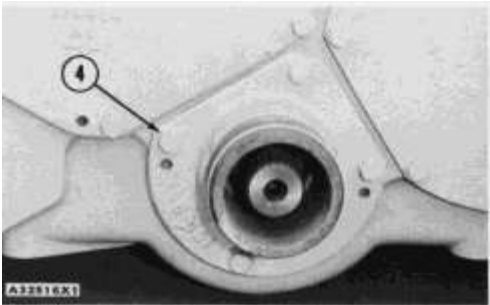

4. Tighten bolts (4).

NOTICE

Be certain that the teeth of the input gear and the input clutch engage correctly before the bolts are tightened to prevent damage.

Disassemble Input Gear

Tools Needed	A	B
8B7548 Puller Assembly	1	1
8B7550 Leg	2	
5H9976 Screw	1	
8H684 Ratchet Box Wrench	1	1
8B7551 Bearing Pulling Attachment	1	
9S9155 Spacer	1	
8H663 Bearing Pulling Attachment		1
8B7560 Step Plate		1

start by:

a) remove input gear

1. Remove the bolt and washer that hold bearing in position.

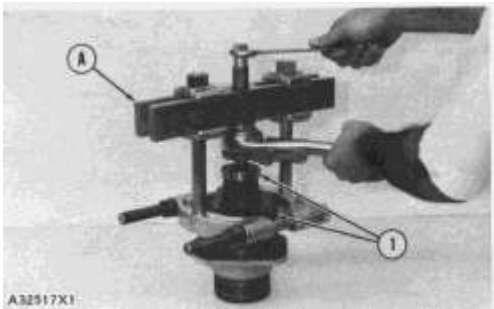

2. Remove gear and bearing (1) as a unit with tooling (A).

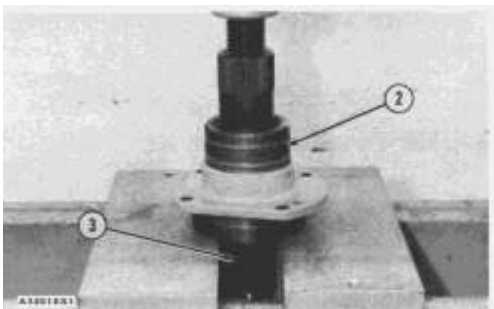

3. Use a press and remove the bearing and shaft (3) from cage (2).

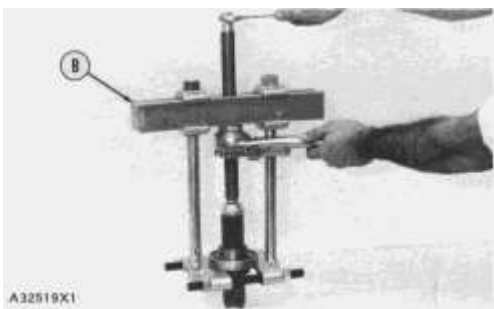

4. Remove the bearing from the shaft with tooling (B).

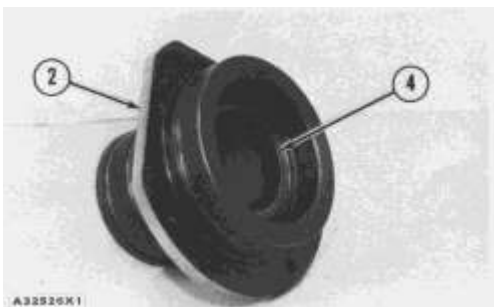

5. Remove seal (4) from cage (2).

Assemble Input Gear

Tools Needed		A
1P531	Handle	1
1P480	Drive Plate	1
1P495	Drive Plate	1

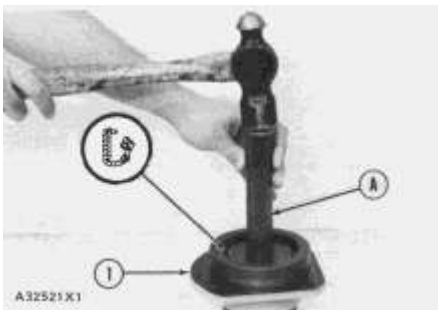

1. Use tooling (A) and install the lip-type seal with lip of the seal toward the inside when cage (1) is installed on the winch.

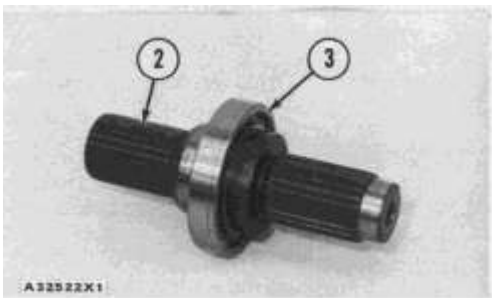

2. Heat bearing (3) in oil to a maximum temperature of 275° F (135° C). Install bearing (3) on shaft (2).

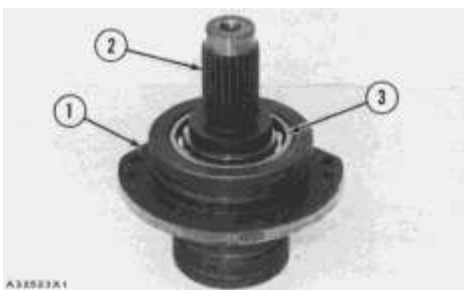

3. Install shaft (2) and bearing (3) in cage (1).

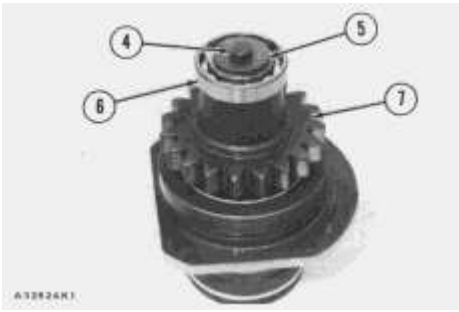

4. Install gear (7) on shaft (2).

5. Heat bearing (6) in oil to a maximum temperature of 275° F (135° C). Install bearing (6) on shaft (2).

6. Install washer (5) and tighten bolt (4).

end by:

a) install input gear

Product: TRACK-TYPE TRACTOR

Model: D4D TRACK-TYPE TRACTOR 59J

Configuration: D4D TRACTOR / POWER SHIFT / 59J01867-UP (MACHINE) POWERED BY 3304 ENGINE

Disassembly and Assembly 54 TOWING WINCH

Media Number -SEN7363-00

Publication Date -01/03/1976

Date Updated -12/10/2001

Input Clutch

SMCS - 5166-11; 5166-12; 5166-15; 5166-16

Remove Input Clutch

Tools Needed		A	B	C
FT522	Bracket	2		
8B7548	Puller Assembly		1	1
1P7461	Leg			2
5P4808	Adapter		2	2
8B7554	Bearing Cup Pulling Attachment		1	1
8H684	Ratchet Box Wrench		1	1
8B7549	Leg		2	
7S7786	Leg		2	

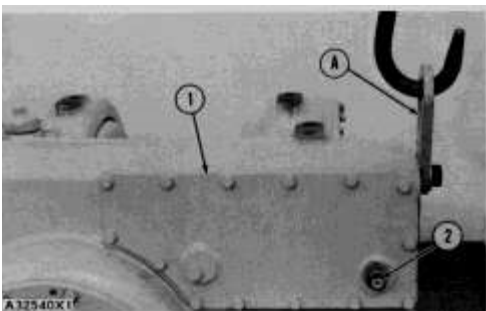

1. Install tool (A) and fasten a hoist to the case.
2. Remove cover (1) and the washer on shaft (2).

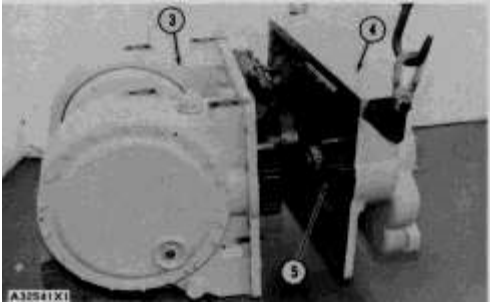

3. Remove the bolts and use two forcing screws 1/2"-13 NC \times 2 1/2 in. long to make a separation of case (4) from case assembly (3).

NOTICE

Clutch assembly (5) and case (4) are removed as a unit from case assembly (3). Do not tilt case (4) backward because clutch assembly (5) is free to fall out of case (4).

4. Put case (4) face down on wooden blocks.
5. Fasten hoist and remove clutch assembly (5) from case (4). Weight of clutch assembly is 90 lb. (40.8 kg).

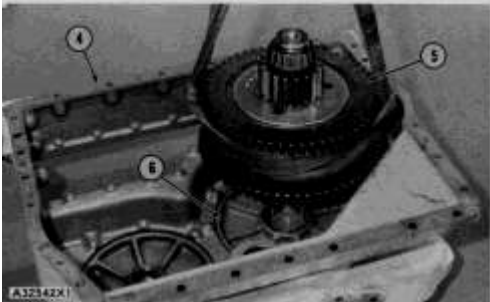

6. Use two 3/8"-16 NC forcing screws and remove cage (6) and the shims. Keep the shims together for installation.

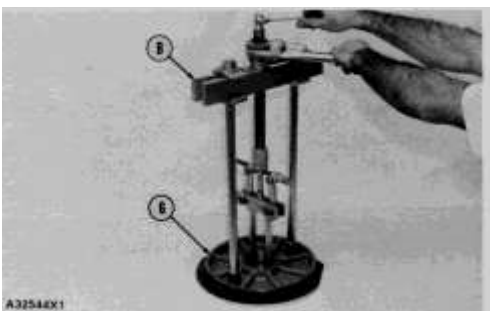

7. Remove the O-ring seal from cage (6).
8. Remove the bearing cup from the cage assembly with tooling (B).

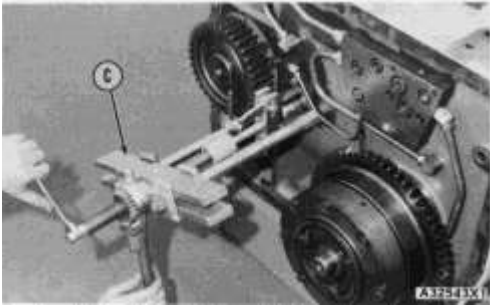

- Remove the bearing cup from the case assembly with tooling (C).

Install Input Clutch

Tools Needed		A
FT522	Bracket	1

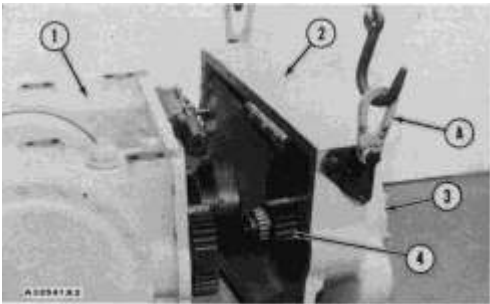

- Clean the gasket material from the surfaces of the case assembly (1) and case (2).
- Lower the temperature of the bearing cups. Install the bearing cups in cage (3) and case assembly (1).
- Install the shims and cage (3) in case (2) without the O-ring seal.

NOTICE

Shims must be installed so that the input clutch shaft has clearance when installed in the case assembly to prevent damage to cage (3) and case assembly (1).

- Use a hoist and install clutch assembly (4) in case (2). Make sure the gear teeth of the clutch assembly and the input gear engage and the clutch assembly bearing seats in cage (3).
- Put 7M7260 Liquid Gasket material on the surfaces of case assembly (1) and case (2).
- Install tool (A) and fasten a hoist to case (2).

7. Put case (2) and clutch assembly (4) in position on case assembly (1). Make sure all gear teeth engage and the bearing of the clutch assembly seats in the bearing cup in case assembly (1). Tighten the bolts.

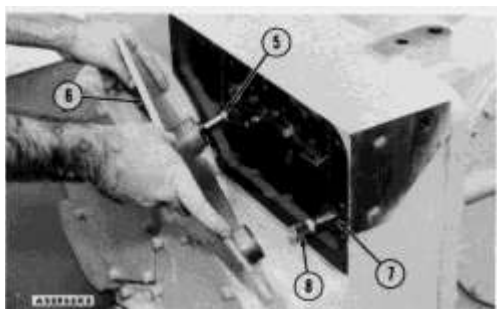

8. Install washer (7) on shaft (8). Install a new gasket and install cover (6) on the case. Make sure sleeve (5) fits in control valve before the bolts are tightened.

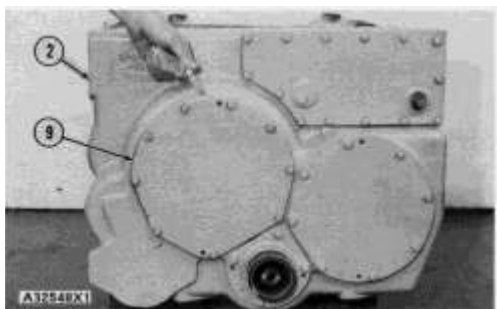

9. Remove cage (9) and the shims. Install cage (9) and tighten the bolts evenly to a torque of 5 lb. in. (.576 N·m).

10. Measure the gap between cage (9) and case (2) at four equally spaced locations with a feeler gauge and make a note of the measurements.

11. Remove cage (9) and install a new O-ring seal on cage (9).

12. Install shims that are the same thickness as the average gap measured plus .003 to .005 in. (0.76 to .127 mm). Install cage (9) and the shims. Tighten bolts evenly.

Disassemble Input Clutch

Tools Needed		A	B
1P820	Hydraulic Puller Group		1
5P3100	Pump Group		1
T774	Spacer		1
8B7551	Bearing Pulling Attachment		1
5F7369	Leg		2
3H465	Plate		4
1B4207	Nut		2
1P531	Handle	1	
1P478	Drive Plate	1	
1P515	Drive Plate	1	

start by:

a) remove input clutch

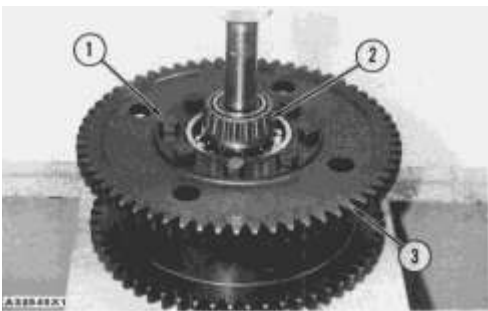

1. Remove bolts (1) and use a press to remove the gear from bearing (2) and the clutch assembly.
2. Remove bearing (2), the spacer and gear (3).



3. There is a counterbore in gear (3). Remove the bearing from the counterbore side of gear with tooling (A).
4. Remove the ring from the bearing.

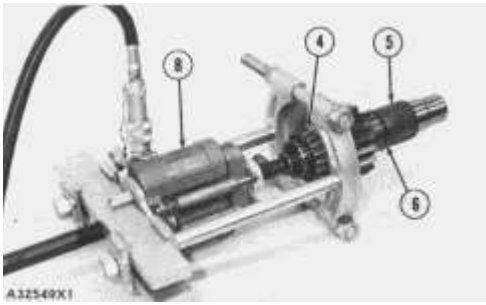

5. Remove the carrier and bearing (4) from gear (5) with tooling (B) and remove the seal from the carrier.

6. Remove O-ring seals (6) from gear (5).

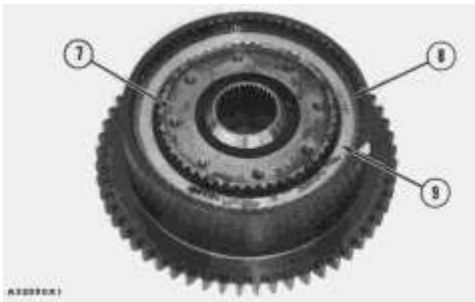

7. Remove ring (8), hub (7), thick plate (9), the five disc assemblies, the four plates and the thick plate.

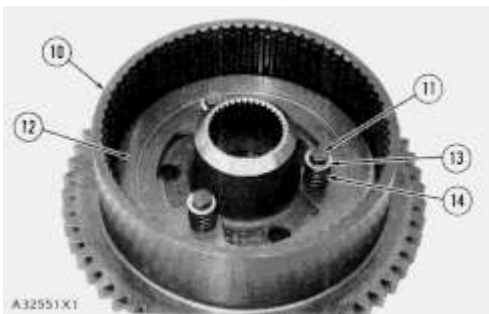

8. Remove bolts (11), washers (13), springs (14) and the spacers.

9. Remove piston (12) from gear (10). Then remove the rings from the piston.



10. Remove ring (15) from gear (10).

11. Remove housing (16) from gear (10).

Assemble Input Clutch

Tools Needed		A
1P531	Handle	1
1P478	Drive Plate	1
1P515	Drive Plate	1

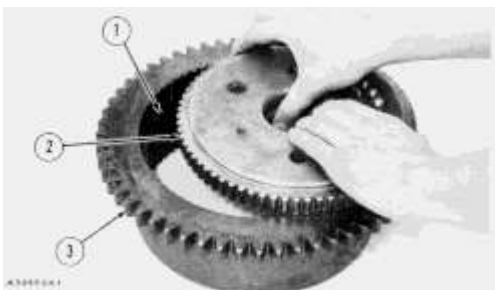

1. Inspect ring (1) for damage and wear. Make a replacement if necessary.
2. Make sure the piston bore in housing (2) is free of sharp edges and clean. Install housing (2) in gear (3).
3. Install the ring that holds housing (2) in position.

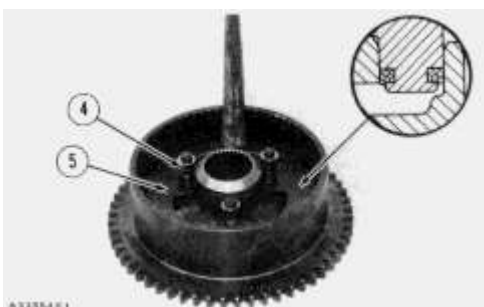

4. Install new seal rings on piston (5) with the lip of the seal toward the bottom of the piston.
5. Put 1P808 General Purpose Lubricant or similar lubricant on the piston rings and the piston bore.

NOTICE

The piston must be installed in the bore evenly to prevent damage to the rings.

6. Put piston (5) in position on housing and install three 3/8"-16 NC x 2 1/2 in. long bolts, the washers, the spacers and springs (4). Tighten bolts to put a light even force on piston (5). Hit the piston lightly until the piston is down all of the way. Remove the three bolts and install the original bolts.

Thank you so much for reading.
Please click the “Buy Now!”
button below to download the
complete manual.



After you pay.

You can download the most
perfect and complete manual in
the world immediately.

Our support email:

ebooklibonline@outlook.com