

Product: TRACK-TYPE TRACTOR  
Model: D5 TRACK-TYPE TRACTOR 95J  
Configuration: D5 TRACTOR / POWER SHIFT / 95J00001-00356 (MACHINE)

## **Disassembly and Assembly GENERAL INSTRUCTIONS**

Media Number -REG00684-03

Publication Date -01/05/1978

Date Updated -09/10/2003

REG006840001

## **General Instructions**

SMCS - 1405-016

## **General Instructions**

The following instructions will prove helpful to disassemble and assemble machine components. The information should be read and then referred to as necessary.

### **Safety**

The safety symbols in the manual indicate an item or procedure where the use of caution and safety is necessary. ALWAYS heed these symbols.

Your safety and that of others is always the number one consideration when working around machines. Safety is a matter of thoroughly understanding the job to be done and the application of good common sense; not just a matter of "do's" and don'ts."

### **Cleanliness**

Clean the connection and the adjacent area before disconnecting hydraulic, fuel or air lines. As soon as the disconnection is made, cap, plug or tape the line or opening to prevent entry of foreign material. The same recommendations for cleaning and covering apply when access covers or inspection plates are removed.

Clean and inspect all parts. Be sure all passages and holes are open. Cover all parts to keep them clean. Be sure parts are clean when installed. Leave new parts in their containers until ready for assembly.

### **Removal And Installation**

Unless otherwise specified, all removals should be accomplished using an adjustable lifting beam. All supporting members (chains and cables) should be parallel to each other and as near perpendicular as possible to the top of the object being lifted.

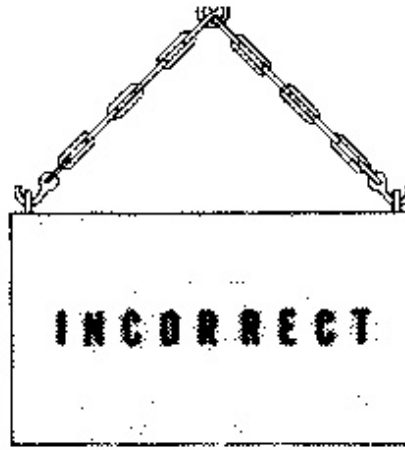
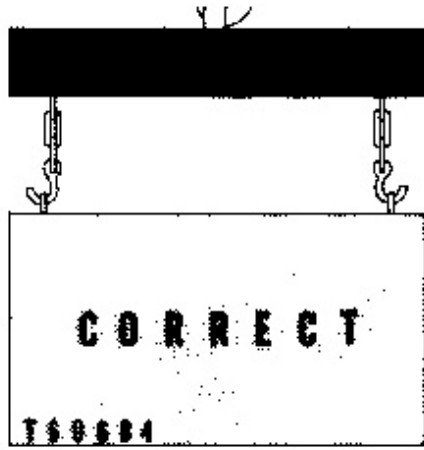

When it is necessary to remove a component on an angle, remember that the capacity of an eyebolt diminishes as the angle between the supporting members and the object becomes less than 90°. Eyebolts and brackets should never be bent and should only have stress in tension. A length of pipe and a washer can be used, as shown, to help relieve these stresses on eyebolts.

Forged eyebolts are available. Each size eyebolt has a maximum load recommendation.

EYEBOLT LOAD RECOMMENDATION			
SIZE	PART NO.	MAXIMUM LOAD	
		lbs.	kg
1/4" - 20	1P7403	600	250
5/16" - 18	1P7404	1125	500
3/8" - 16	1P7405	1625	700
7/16" - 14	1P7406	2250	1000
1/2" - 13	1P7407	3000	1350
5/8" - 11	2D1201	5000	2250
3/4" - 10	1P7409	6250	2800



Some removals require the use of lifting fixtures to obtain proper balance and to provide safe handling.

If a part resists removal, check to be certain all nuts and bolts have been removed and that an adjacent part is not interfering.

## **Cleaning And Handling Of Parts**

Use caution during removal and installation of parts to prevent damage when handling. Many parts may be used again if not damaged by removal methods. Never discard an expensive part without first cleaning it to see if it can be used again.

Parts that are to be reused should be protected with a coating of oil or corrosion preventive material until they are installed. Do not store parts outside unless they have corrosion protection and they are covered.

Before installation of new or reusable parts, clean the corrosion preventive material from the machined surfaces. Use a cleaning solvent that will not destroy the material being cleaned (an example is aluminum).

Inspect the parts for damage caused by handling. Many nicks and burrs can be removed with crocus cloth or a fine grain polishing stone.

See the correct Service Manual or Guideline for Reusable Parts for more information.

## **Disassembly And Assembly**

When assembling a machine, complete each step in turn. Do not partially assemble one part and start assembling some other part. Make all adjustments as recommended. Always check the job after it is completed to see nothing has been overlooked.

## **First Operation Of A Rebuilt Engine**

Use the following procedure:

1. If the diesel engine has a starting engine, use the starting engine to make the engine turn for 10 minutes.
2. Start the diesel engine, then run the engine at low RPM for 10 minutes. Make correct low idle governor adjustment. Check the pressure of the cooling system and the lubrication system. Look for leaks of water and of oil.
3. Run the engine at  $\frac{3}{4}$  of full RPM with  $\frac{1}{2}$ load for 15 minutes.
4. Run the engine at full RPM and make correct high idle governor adjustment, then run engine at full RPM and with full load for 30 minutes.

## **Service Tools**

### **Puller Assembly (2 or 3 Arm)**

Two or three arm puller assemblies can be used to remove gears, bearing cages, hubs, bearings, shafts, etc.

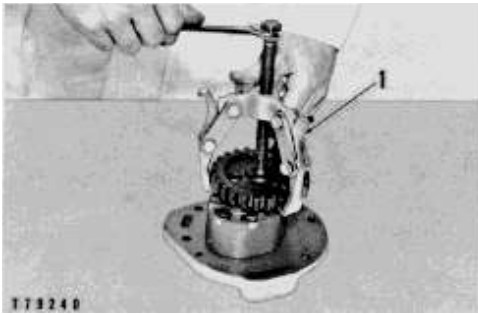

EXAMPLE OF TOOL INSTALLATION

1. Puller.

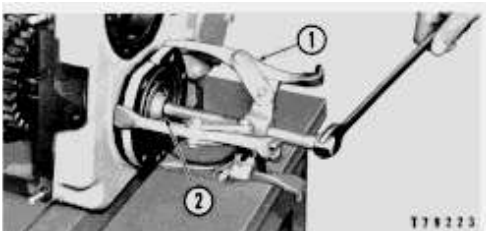

EXAMPLE OF TOOL INSTALLATION

1. Puller. 2. Step plate.

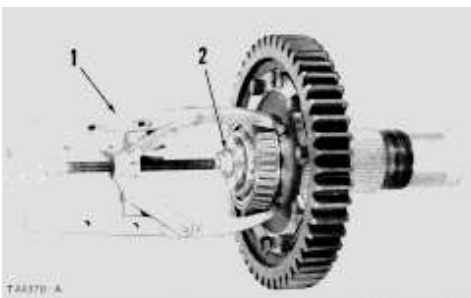

EXAMPLE OF TOOL INSTALLATION

1. Puller. 2. Step plate.

## **Bearing Pulling Attachment**

Bearing Pulling Attachments can be used with forcing bolts, to remove shafts, bearings, gears, etc. They can be used with Push-Pullers to provide a variety of pulling combinations.

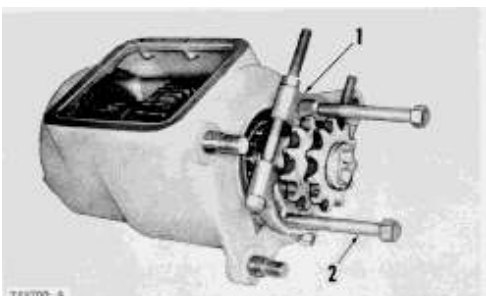

EXAMPLE OF TOOL INSTALLATION

1. Bearing puller attachment.
2. Forcing screws.

### Bearing Cup Pulling Attachment

Bearing Cup Pulling Attachments are used to remove bearing races or cups, sleeve-type bearings, bearings, seats, etc. and can be used with Push Pullers.

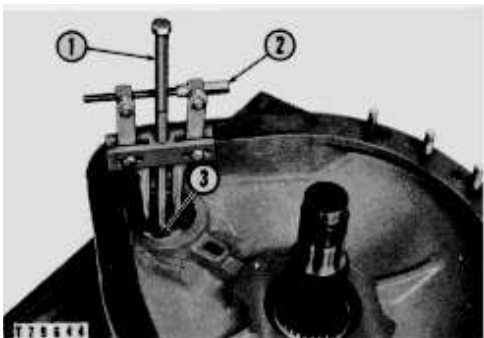

EXAMPLE OF TOOL INSTALLATION

1. Screw.
2. Bearing cup puller attachment.
3. Step plate.

### Push Pullers

Push Pullers can be used to remove pulleys, gears, shafts, etc., and can be used in a variety of pulling combinations.

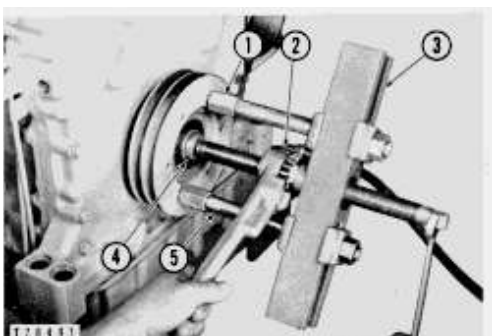

EXAMPLE OF TOOL INSTALLATION

1. Adapters (use as required).
2. Ratchet box wrench.
3. Push puller.
4. Step plate.
5. Legs.

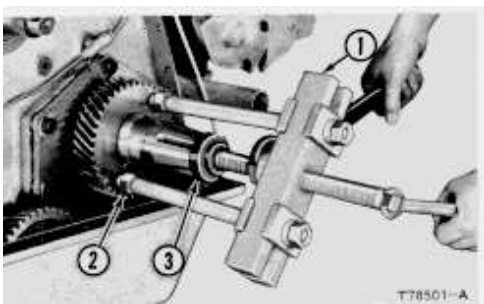

EXAMPLE OF TOOL INSTALLATION

1. Push puller.
2. Adapter.
3. Step plate.

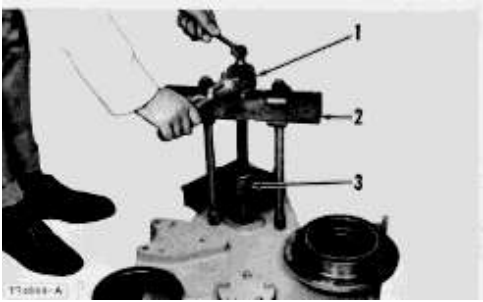

EXAMPLE OF TOOL INSTALLATION

1. Ratchet box wrench. 2. Push puller. 3. Reducing adapter.

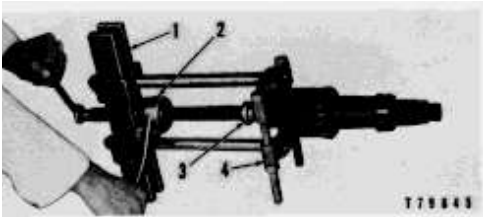

EXAMPLE OF TOOL INSTALLATION

1. Push puller. 2. Ratchet box wrench. 3. Step plate. 4. Bearing puller attachment.

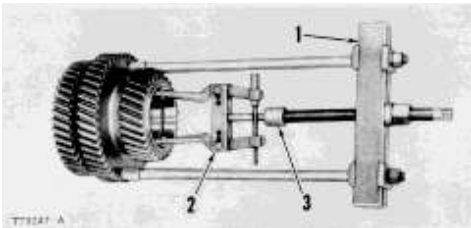

EXAMPLE OF TOOL INSTALLATION

1. Push puller. 2. Bearing cup puller attachment. 3. Reducing adapter.

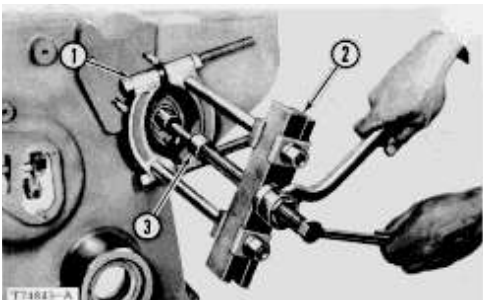

EXAMPLE OF TOOL INSTALLATION

1. Bearing puller attachment. 2. Push puller. 3. Reducing adapter.

## Tool Safety

**RULE 1-Always use safe tools.**

**RULE 2-Keep tools in safe condition.**

**RULE 3-Use the right tool for the job.**

**RULE 4-Safety sense with tools pays off.**

## **Pressing Parts**

When pressing one part into another, use 9M3710 Anti-Seize Compound or a molybdenum disulfide base compound to lubricate the mating surfaces.

Assemble tapered parts dry. Before assembling parts with tapered splines, be sure the splines are clean, dry and free from burrs. Position the parts together by hand to mesh the splines before applying pressure.

If parts which are fitted together with tapered splines are not tight, inspect the tapered splines and discard if worn.

## **Bolts And Bolt Torque**

A bolt which is too long may "bottom" before the head is tight against the part it is to hold. The threads can be damaged when a "long" bolt is removed.

If a bolt is too short, there may not be enough threads engaged to hold the part securely.

Apply proper torque values to all bolts and nuts when assembling Caterpillar equipment. When a specific torque value is required, the value is listed in the SPECIFICATION section of the Service Manual. Tighten all other bolts and nuts for general usage, hydraulic valve bodies, or taperlock studs to the torque values given in the charts.

## **T-T-T Procedure**

A torque-turn-tighten (T-T-T) procedure is used in many specifications and instructions.

1. Clean the bolt and nut threads.
2. Put lubricant on the threads and the seat face of the bolt and the nut.
3. Turn the bolt or the nut tight according to the torque specification.

TURN TIGHTER CHART	
TURN (BOLT OR NUT)	TURN DEGREES
1	360°
1/2	180°
1/3	120°
1/4	90°
1/6	60°
1/12	30°

- Put a location mark on the part and on the bolt or the nut.
- Turn the bolt or the nut tighter by the amount of degrees shown in the specifications.

**NOTE:** The side of a nut or bolt head can be used for reference if a mark can not be put on.

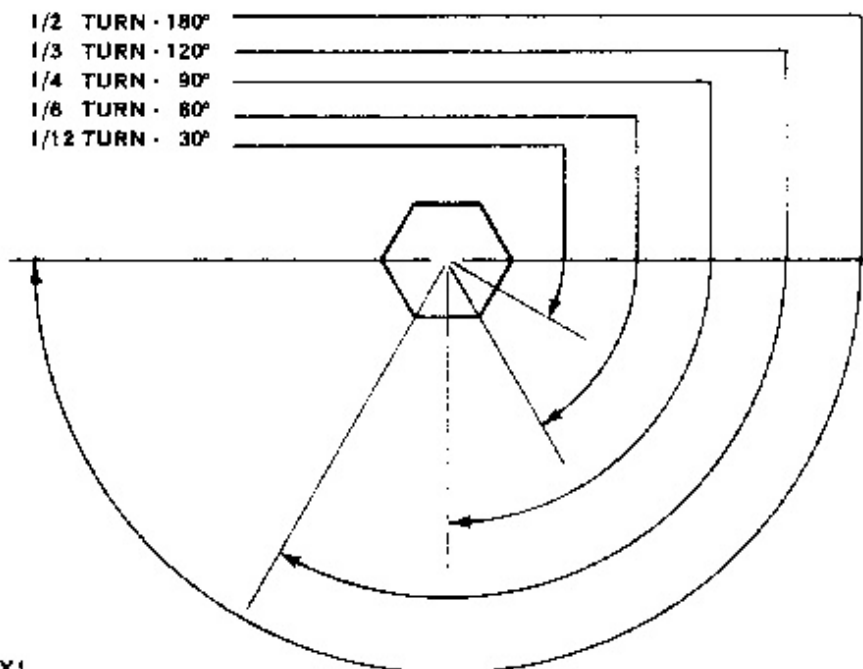

### Torque Wrench Extension

When a torque wrench extension is used with a torque wrench, the torque indication on the torque wrench will be less than the real torque.



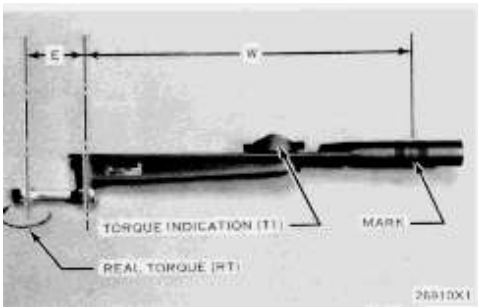

#### TORQUE WRENCH WITH TORQUE WRENCH EXTENSION

E. Dimension from torque wrench drive axis to torque wrench extension drive axis. W. Dimension from mark on handle to torque wrench drive axis.

1. Put a mark on the handle. Measure the handle from the mark to the axis of the torque wrench drive (W).
2. Measure the torque wrench extension from the torque wrench drive to the axis of the torque wrench extension drive (E).
3. To get correct torque indication (TI) when the real torque (RT) is known:

$$TI = \frac{RT \times W}{W + E}$$

Example: W = 12 in. (305 mm); E = 2.56 in. (65 mm); RT (from specifications) = 125 lb. ft. (170 N·m).

$$\begin{aligned}
 TI &= \frac{125 \times 12}{12 + 2.56} \quad \text{or } 103 \text{ lb. ft.} \\
 &= \frac{(170 \times 305)}{(305 + 65)} \quad \text{or } (140 \text{ N}\cdot\text{m})
 \end{aligned}$$

4. Hold the torque wrench handle with the longest finger of the hand over the mark on the handle to get the real torque (RT) with low torque indication (TI) on the torque wrench.

### **Torque Multipliers**

The capacity of a torque wrench is increased when it is used with a torque multiplier. The Tool Guide shows several torque multipliers with different capacities.

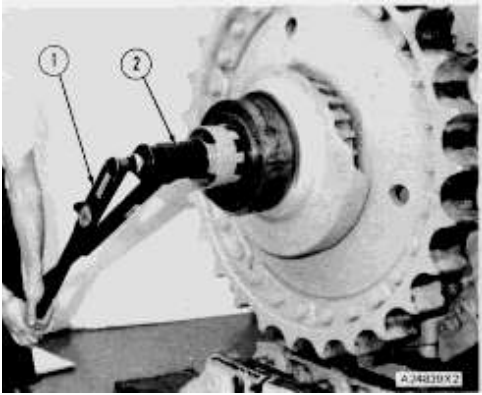

### 5P3508 TORQUE MULTIPLIER

1. Torque wrench. 2. Torque multiplier.

A 1P850 Torque Multiplier is used with the hydraulic cylinder repair stand. An 8H8561 Adapter is needed when a torque wrench with a 1/2 inch (12.7 mm) drive is used with the 1P850 Torque Multiplier.

Chart (5) under the torque multiplier handle has the torque wrench input torque and the torque multiplier output torque.

When the T-T-T (torque-turn-tighten) procedure is needed, use 60° protractor (3). The protractor is used with six marks (4) to tighten the nut correctly.

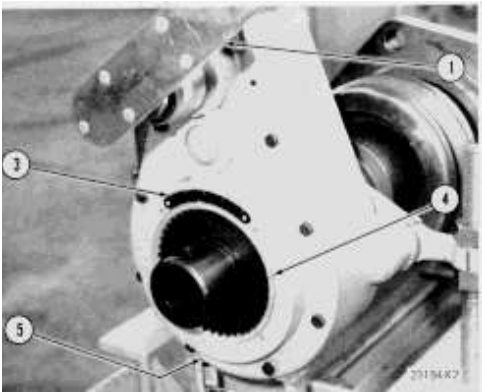

### 1P850 TORQUE MULTIPLIER (USED WITH HYDRAULIC CYLINDER REPAIR STAND)

1. Torque wrench. 3. 60° Protractor. 4. Six marks (60° apart). 5. Chart (under handle).

## Locks

Flat metal locks must be installed properly to be effective. Bend one end of the lock around the edge of the part. Bend the other end against one flat surface of the nut or bolt head.

Always install new locks in compartments which house moving parts.

When installing lockwashers on housings made of aluminum, use a flat washer between the lockwasher and the housing.

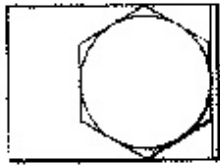

180667 CORRECT

CORRECT

INCORRECT

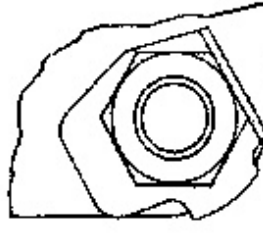
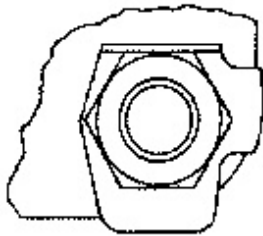

CORRECT

INCORRECT

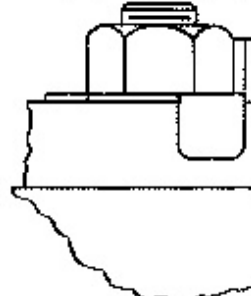
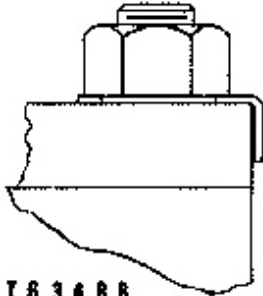

T83488

## Lines And Wires

When removing or disconnecting a group of lines or wires, tag each one to assure proper assembly.

## Lubrication

Where applicable, fill the compartments of the components serviced with the amount, type and grade of lubricant recommended in the Lubrication and Maintenance Guide section of the Service Manual.

## Shims

When shims are removed tie them together and identify them as to location. Keep shims clean and flat until they are reinstalled.

## Bearings

## Anti-Friction Bearings

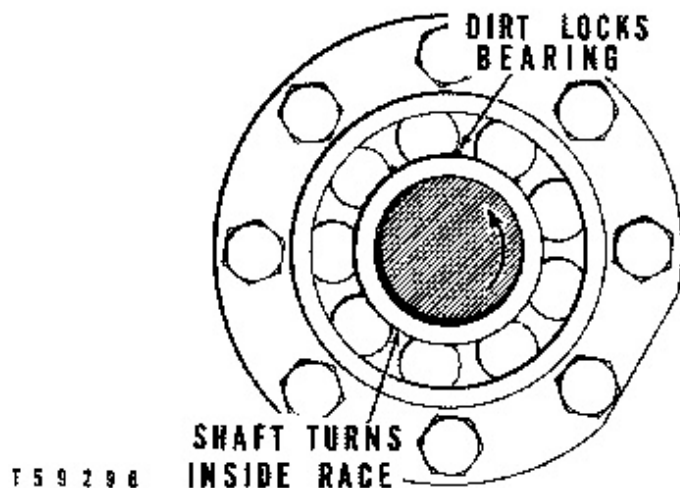

When an anti-friction bearing is removed, cover it to keep out dirt and abrasives. Wash bearings in nonflammable cleaning solution and allow them to drain dry. The bearing may be dried with compressed air but **DO NOT SPIN THE BEARING**.

Discard the bearings if the races and balls or rollers are pitted, scored or burned. If the bearing is serviceable, coat it with oil and wrap it in clean paper. Do not unwrap new bearings until time of installation.

The life of an anti-friction bearing will be shortened if not properly lubricated.

## Double Row, Tapered Roller

Double row, tapered roller bearings are precision fit during manufacture and the components are not interchangeable. The cups, cones and spacers are usually etched with the same serial number and letter designator. If no letter designators are found, wire the components together to assure correct installation. Reusable bearing components should be installed in their original positions.

## Heating Bearings

Bearings which require expansion for installation should be heated in oil not to exceed 250° F. (121° C.). When more than one part is heated to aid in assembly, they must be allowed to cool and then pressed together again. Parts often separate as they cool and shrink.

## Installation

Lubricate new or used bearings before installation. Bearings that are to be preloaded must have a film of oil over the entire assembly to obtain accurate preloading. When installing a bearing, spacer or washer against a shoulder on a shaft, be sure the chamfered side is toward the shoulder.

When pressing bearings into a retainer or bore, apply pressure to the outer race. If the bearing is pressed on the shaft, apply pressure on the inner race.

## Preload

Preload is an initial force placed on the bearing at the time of assembly.

Determine preload or end clearance from the SPECIFICATIONS. Care should be exercised in applying preload. Misapplication of preload to bearings requiring end clearance can result in bearing failure.

## **Sleeve Bearings**

DO NOT INSTALL SLEEVE BEARINGS WITH A HAMMER. Use a press if possible and apply the pressure directly in line with the bore. If it is necessary to drive on a bearing use a driver or a bar with a smooth flat end. If a sleeve bearing has an oil hole, align it with the oil hole in the mating part.

## **Gaskets**

Be sure the holes in the gaskets correspond with the lubricant passages in the mating parts. If it is necessary to make gaskets, select stock of the proper type and thickness. Be sure to cut holes properly. Blank gaskets can cause serious damage.

## **Batteries**

Clean batteries by scrubbing with a solution of baking soda and water. Rinse with clear water. After cleaning, dry thoroughly, coat terminals and connections with anti-corrosion compound or grease.

If an engine is not to be used for a long period of time, remove the batteries. Store them in a warm, dry place, on wooden shelves. Never store on concrete. A small charge should be introduced periodically to keep the specific gravity rating at recommended level.

## **Brake Linings**

Replace brake linings before they have worn enough for rivet heads to contact and score the brake drums.

## **Seals**

### **Duo-Cone Floating Seals**

Floating ring seals have highly finished surfaces and are held together by toric sealing rings. The flexibility of the toric sealing rings makes the floating ring seals self aligning and compensates for wear on the metal faces.

During disassembly, tape the metal floating ring seals together so they will be kept in matched sets. Always install the metal floating ring seals in pairs; that is, two new seals together or two seals that have previously run together. Never reinstall a used toric sealing ring.

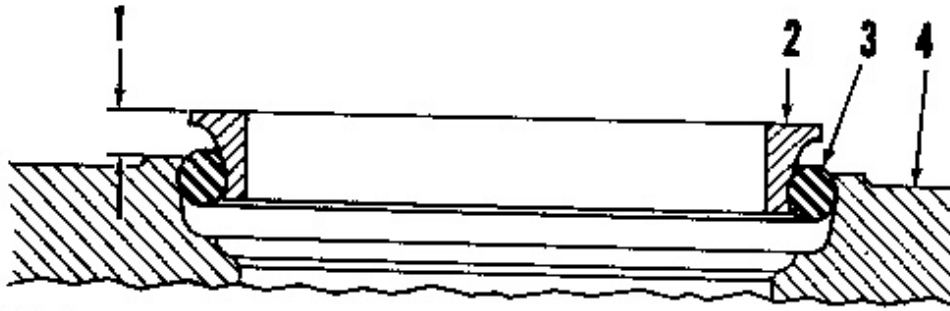

T87199

#### CORRECT INSTALLATION

1. Dimension. 2. Metal floating ring seal. 3. Rubber toric sealing ring. 4. Toric sealing ring retainer.

The illustration shows the dimension (1) to be checked, the metal floating ring seal (2), the rubber toric sealing ring (3) and the toric sealing ring retainer (4). The dimension must be uniform around the entire circumference of the floating ring seal. Check the dimension at 90° intervals.

Handle all parts with care to avoid nicks. File smooth any parts, other than the sealing faces, that have nicks that may make assembly difficult or questionable. Wash used parts. Use a wire brush to clean dirt or rust from the bore of the seal retainers to assure they are clean and smooth. Remove all oil or the protective coating from floating ring seals and retainers with a nonflammable cleaning solvent. Be sure the ramp on the retainers and on the floating ring seals is dry.

Check the ramps for tool marks and nicks. On used parts, remove dirt or rust deposits from the ramps. Smooth the surface with emery cloth.

Install new toric sealing rings or floating ring seals. Seat the toric sealing ring uniformly in the relief of the ring seal. Be sure the toric sealing ring is not twisted. It must set straight against the lip which keeps it from falling off the floating ring seal.

Duo-Cone floating seal installation tools are available for various size seals. See the Power Train Tools section of the Tool Guide for a list of installation tools. A typical installation tool is shown in the illustration.



T41228

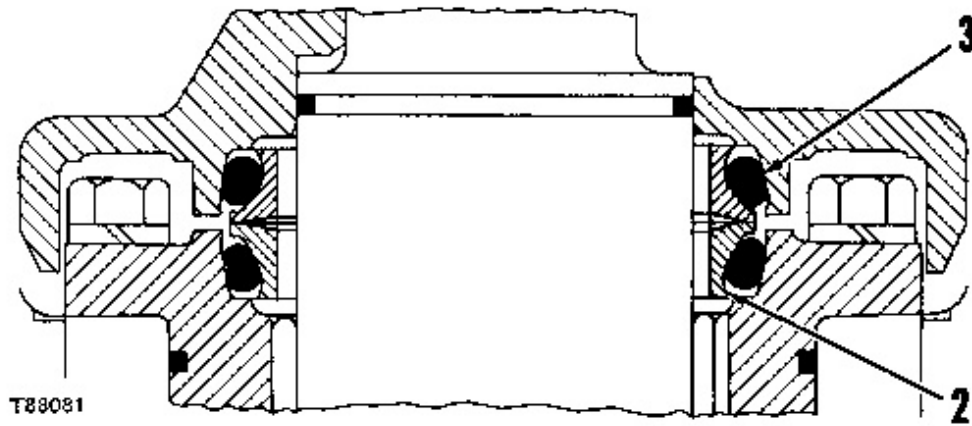

#### DUO-CONE SEAL INSTALLED

2. Metal floating ring seal. 3. Rubber toric sealing ring.

If an installer tool is not used, install the toric sealing ring and floating ring seal as an assembly by pressing on the toric sealing ring. Use finger pressure only. Be sure the toric sealing ring is seated uniformly in the recess of both the floating ring seal and the retainer. Make sure it sets in the bore straight and against the lip that keeps it from falling out of the retainer. **DO NOT USE A SCREWDRIVER OR STICK TO ASSEMBLE THE TORIC SEALING RING IN THE RETAINER.**

Before assembling floating ring seals together, wipe faces of seals with lint-free tissue to remove any foreign material and fingerprints. Place one drop of oil on the cleaning tissue and coat the sealing surfaces of the seals. Be careful to prevent any oil from contacting the toric sealing ring or its mating surfaces.

### Lip-Type Seals

Generally the toe or spring-loaded lip of an oil seal faces the oil being sealed or the oil having the higher pressure. The toe or lip of a grease seal faces away from the lubricant being sealed. Unless otherwise specified, use the preceding rules for installing lip-type seals.

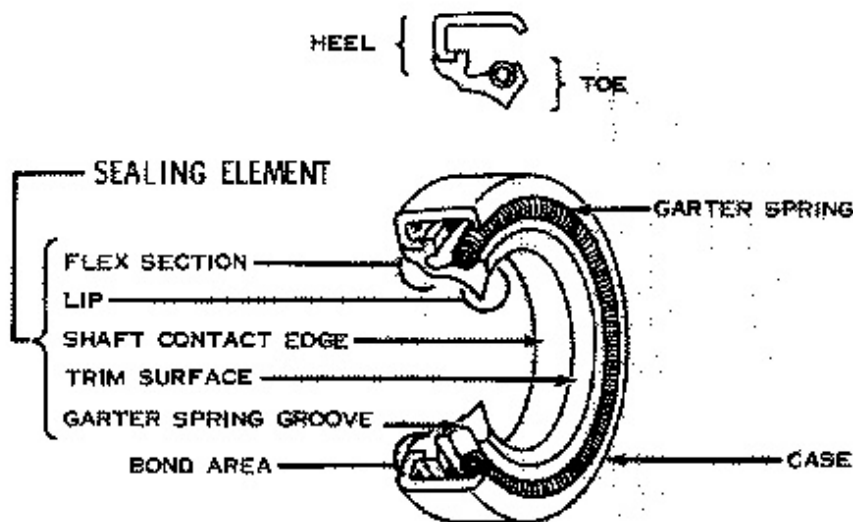

The main parts of a lip-type seal are the case, sealing element, and garter spring. The picture illustrates the construction of a simple lip-type seal. The cross sections show the terms "heel" and "toe" used to identify the sides of various types of seals.

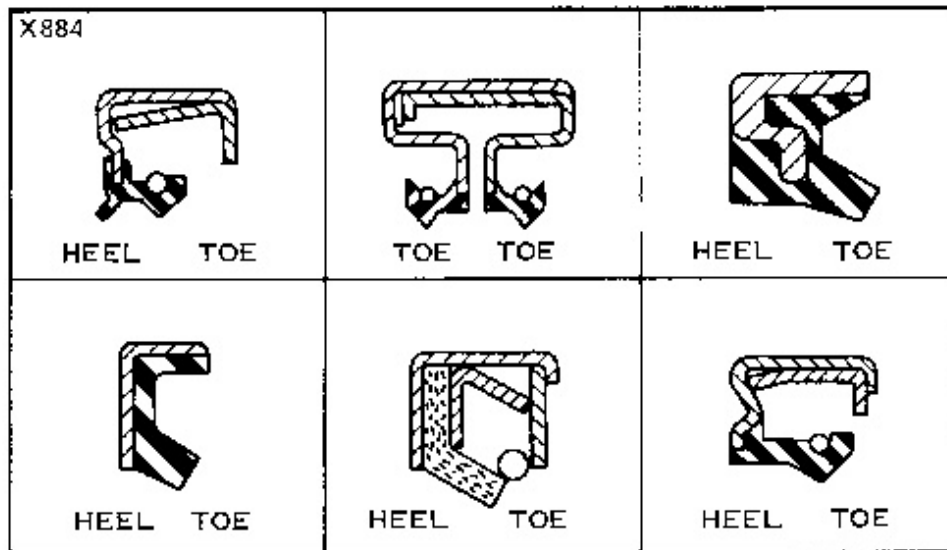

Lubricate the lips of lip-type seals before installation. Use the same type lubricant in which the seal will be operating. Do not use grease on any seal except a grease seal.

If, during installation, the seal lip must pass over a shaft that has splines, a keyway, rough surface or a sharp edge, the lip can be easily damaged. Shim stock or other such material can be formed around the area to provide a smooth surface over which to slide the seal.

## Hydraulic Systems

### Cleanliness

... When removing components of a hydraulic system cover all openings in both the component and the machine.

... If evidence of metal or rubber particles are found in the hydraulic system, flush the entire system.

... Disassemble and assemble hydraulic components on a clean surface. Clean all metal parts in a nonflammable cleaning fluid. Then lubricate all components to aid in assembly.

### Safety

Before servicing the hydraulic system, **NEUTRALIZE THE HYDRAULIC PRESSURE.**

PROCEDURE:

1. Lower all implements to the ground. In some instances a removal procedure may require the implement to be blocked in a certain position.
2. With the engine shut off, move the hydraulic control levers to all positions to insure there is no pressure in the system.
3. Place all control levers in HOLD position.



**NOTE:** When attached hydraulic equipment is removed from a machine which will continue to be used, the hydraulic system lines must be securely blocked. High pressure protective covers are available. The following chart lists the protective covers for various size hydraulic hoses. One O-ring seal is required with each protective cover.

APPROXIMATE HOSE SIZE				PRO-TECTIVE COVER	O-RING SEAL	TWO BOLT FLANGE	SPLIT FLANGE
INCHES		MILLIMETERS					
O.D.	I.D.	O.D.	I.D.				
1.00	.50	25.4	12.7	5H4017	5F7054	5F6804	1H5278
1.06	.62	26.9	15.7	8S7668	4J8996	—	6K3253
1.25	.75	31.7	19.0	5H4018	5F1678	5F2046	2K190
1.50	1.00	38.1	25.4	5H4019	4F7391	5F2442	1H3305
2.00	1.25	50.8	31.7	5H4020	4F7952	—	3H3667
2.25	1.50	57.1	38.1	2J2668	7F8267	—	3H4330

### **Sealing Elements**

Inspect all sealing elements (O-rings, gaskets, etc.) when disassembling and assembling hydraulic system components. Install new elements if necessary.

Always use the recommended Caterpillar part number when installing new sealing elements. Seals may resemble one another but will not necessarily be compatible in a given application.

### **Hydraulic Line Installation**

1. For a metal tube to hose installation, install the tube and tighten all bolts finger tight.
2. Tighten the bolts at the rigid end.
3. Install the hose and tighten all bolts finger tight.
4. Put the hose in a position so that it does not make contact with the machine or another hose.
5. Tighten the bolts on both connections.
6. Start the engine.
7. Move the implement control levers to all positions.
8. Look at the hose during movement of the implement. Make sure hose is not in contact with the machine or other hoses.

---

### **NOTICE**

**Do not use the thin sheet metal covers designed for shipping and storage. These covers can rupture when high pressure is applied.**

Thank you so much for reading.  
Please click the “Buy Now!”  
button below to download the  
complete manual.



After you pay.

You can download the most  
perfect and complete manual in  
the world immediately.

Our support email:

[ebooklibonline@outlook.com](mailto:ebooklibonline@outlook.com)