

Product: TRACK-TYPE TRACTOR

Model: D5K2 LGP TRACK-TYPE TRACTOR TRF

Configuration: D5K2 XL & LGP Track Type Tractor TRF00001-UP (MACHINE) POWERED BY C4.4 Engine

Disassembly and Assembly D3K2, D4K2 and D5K2 Track-Type Tractors Power Train

Media Number -KENR5645-01

Publication Date -01/02/2012

Date Updated -26/10/2018

i04406333

Final Drive

SMCS - 4050

Specifications

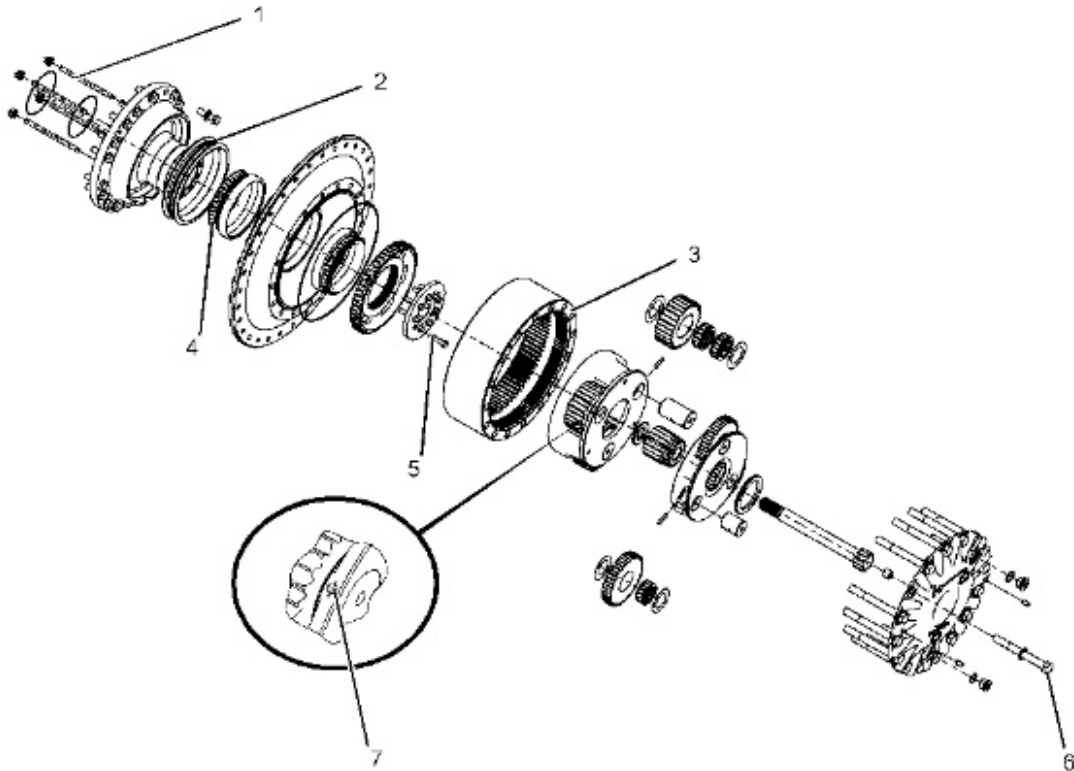

Table 1

Specification for 346-9793 Final Drive Gp			
Item	Qty	Part	Specification Description
1	4	113-8215 Taperlock Stud	Torque to 65 ± 10 N·m (48 ± 7 lb ft)
2	1	326-9200 Duo-Cone Seal Gp	The rubber toric seal and all surfaces that contact the seal must be clean and dry at assembly. Apply a thin film of oil to the contacting surfaces of the metal ring prior to assembly. The seal ring must be assembled square with the bore. Bulging or twisting in the rubber toric seal is not allowed.
3	1	272-2317 Ring Gear	Apply blue Loctite High Flex GM for ring gear before assembly.
4	2	8T-0072 Bearing Cone	<ol style="list-style-type: none"> 1. Heat the bearing cup and the cone to 120 °C (248 °F) for a maximum of 8 hours. 2. Install the bearing and the cone. 3. After the bearing assembly has cooled, locate the assembly squarely against locating shoulder. 4. Lubricate the bearing with lubricant prior to installation in the case or the cage.
5	9	8T-4194 Bolt	Torque to 120 ± 20 N·m (89 ± 15 lb ft)
6	16	7X-2568 Bolt	Torque to 520 ± 70 N·m (384 ± 52 lb ft)
7	6	095-0891 Spring Pin	Deform pin hole slightly to the distance of 1.5 ± 1.0 mm (0.06 ± 0.04 inch)

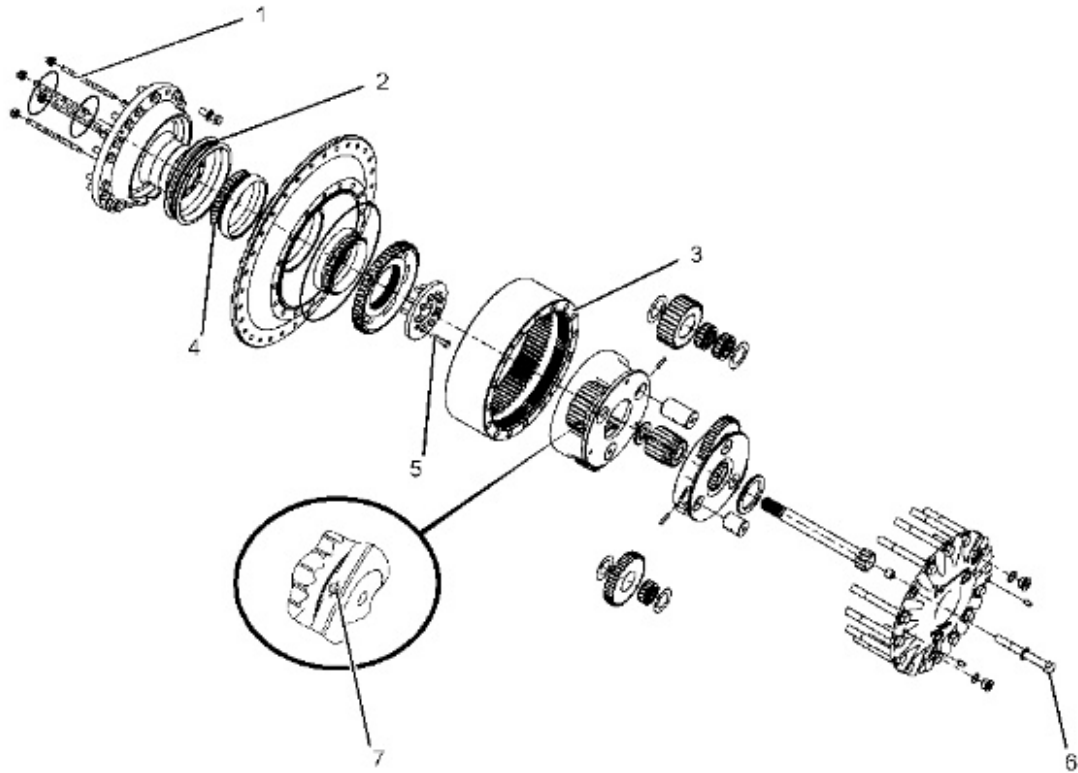

Illustration 2

g02762513

Table 2

Specification for 346-9794 Final Drive Gp and 346-9795 Final Drive Gp			
Item	Qty	Part	Specification Description
1	4	113-8216 Taperlock Stud	Torque to 110 ± 20 N·m (81 ± 15 lb ft).
2	1	326-9200 Duo-Cone Seal Gp	The rubber toric seal and all surfaces that contact the seal must be clean and dry at assembly. Apply a thin film of oil to the contacting surfaces of the metal ring prior to assembly. The seal ring must be assembled square with the bore. Bulging or twisting in the rubber toric seal is not allowed. Refer to Special Instruction, SEHS8364-03, "Assembly and Installation of Conventional Duo-Cone Seals" for installation instructions.
3	1	272-2317 Ring Gear	Apply blue Loctite High Flex GM for ring gear before assembly.

4	2	8T-0072 Bearing Cone	1. Heat the bearing cup and the cone to 120 °C (248 °F) for a maximum of 8 hours. 2. Install the bearing and the cone. 3. After the assembly has cooled, locate the assembly squarely against locating shoulder. 4. Lubricate the bearing with lubricant prior to installation in the case or the cage.
5	9	8T-4194 Bolt	Torque for 120 ± 20 N·m (89 ± 15 lb ft).
6	16	7X-2568 Bolt	Torque for 520 ± 70 N·m (384 ± 52 lb ft).
7	6	095-0891 Spring Pin	Deform pin hole slightly to the distance of 1.5 ± 1.0 mm (0.07 ± 0.04 inch).

Removal Procedure

Table 3

Required Tools			
Tool	Part Number	Part Description	Qty
A	138-7575	Link Bracket	1
B	1U-9200	Lever Puller Hoist	1

Start By:

- a. Remove the parking brake.
- b. Remove the sprocket.

Note: Cleanliness is an important factor. Before you begin the removal procedure, thoroughly clean the exterior of the components. This will help to prevent dirt from entering the internal mechanism.

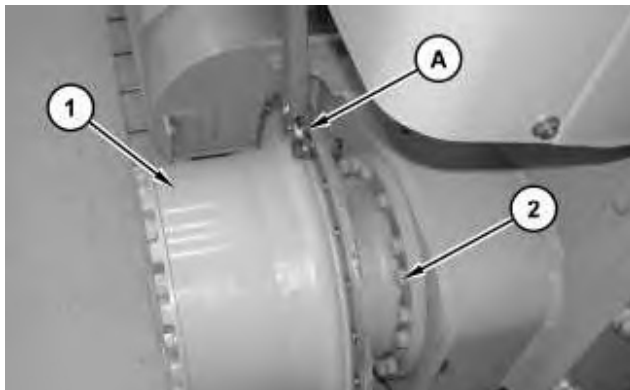

Illustration 3

g01362287

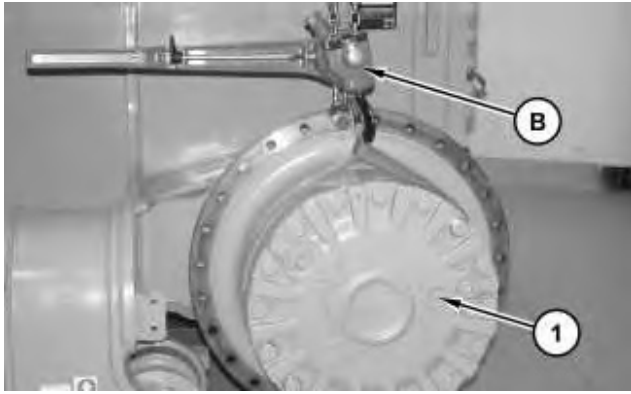

Illustration 4

g01362304

1. Attach Tooling (A), Tooling (B), and suitable lifting devices to final drive assembly (1). The weight of final drive assembly (1) is approximately 363 kg (800 lb).
2. Remove bolts (2).
3. Remove final drive assembly (1).

Installation Procedure

Table 4

Required Tools			
Tool	Part Number	Part Description	Qty
A	138-7575	Link Bracket	1
B	1U-9200	Lever Puller Hoist	1

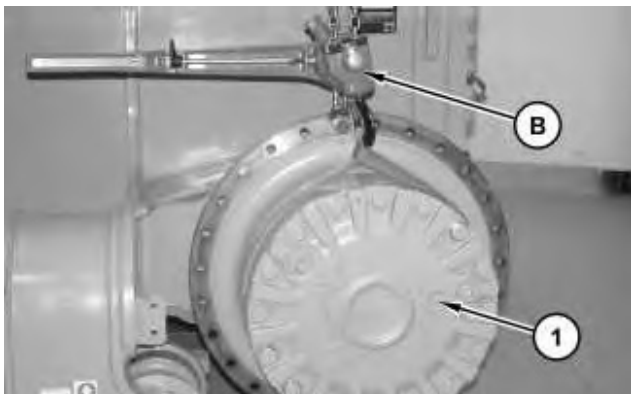

Illustration 5

g01362304

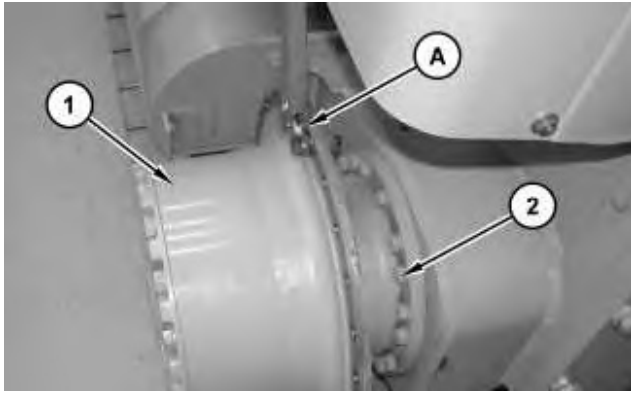

Illustration 6

g01362287

1. Attach Tooling (A), Tooling (B), and a suitable lifting device to final drive assembly (1). The weight of final drive assembly (1) is approximately 363 kg (800 lb).
2. Position final drive assembly (1) and install bolts (2).
3. Remove Tooling (A), Tooling (B), and suitable lifting devices from final drive assembly (1).

End By:

- a. Install the sprocket.
- b. Install the parking brake.

Disassembly Procedure

Table 5

Required Tools			
Tool	Part Number	Part Description	Qty
A	1P-2420	Transmission Repair Stand	1
B	154-6182	Forcing Bolt	1
C	4C-8358	Eyebolt	1
D	138-7575	Link Bracket	3
E	150-1782	Crossblock	1
	1P-0525	Plate	1
	6V-9667	Bolt	2
	8T-3282	Hard Washer	2
	5F-7366	Forcing Screw	1
	5B-0637	Nut	1
F	138-7574	Link Bracket	2

Start By:

- a. Remove the final drive.

Note: Mark all components for assembly purposes.

Cleanliness is an important factor. Before the disassembly procedure, thoroughly clean the exterior of the component. This will help to prevent dirt from entering the internal mechanism.

1. Put an alignment mark across the sections of the final drive for assembly purposes. The parts must be reinstalled in the original locations.

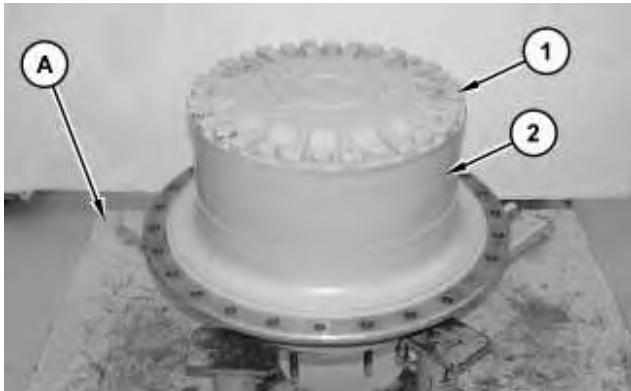

Illustration 7

g01363580

2. Position final drive assembly (2) onto Tooling (A). Remove bolts (1).



Illustration 8

g01363590

3. Use Tooling (B) in order to remove cover assembly (3).
-

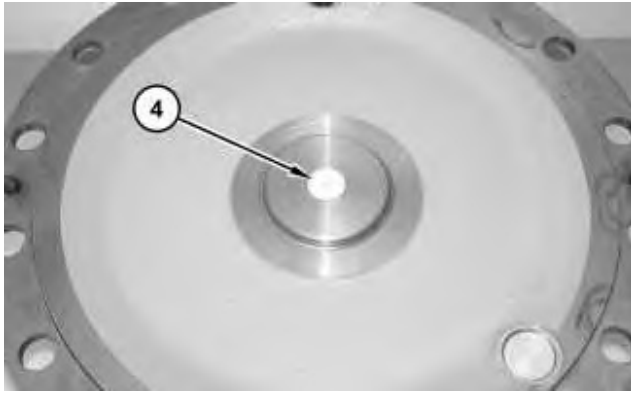

Illustration 9

g01363593

4. Remove plug (4).



Illustration 10

g01363600

5. Remove spacer (5).

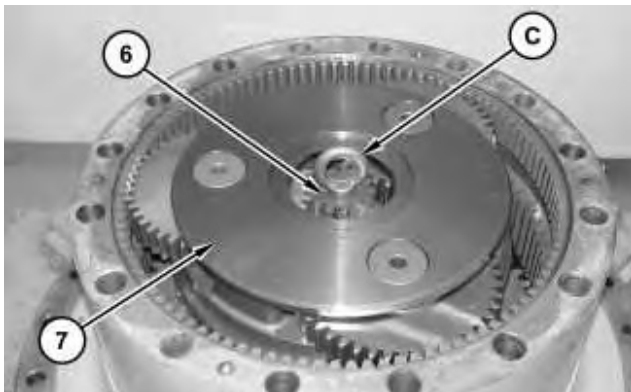

Illustration 11

g01363616

6. Use Tooling (C) in order to remove sun gear (6). Use two people to remove planetary carrier (7). The weight of planetary carrier (7) is approximately 23 kg (50 lb).

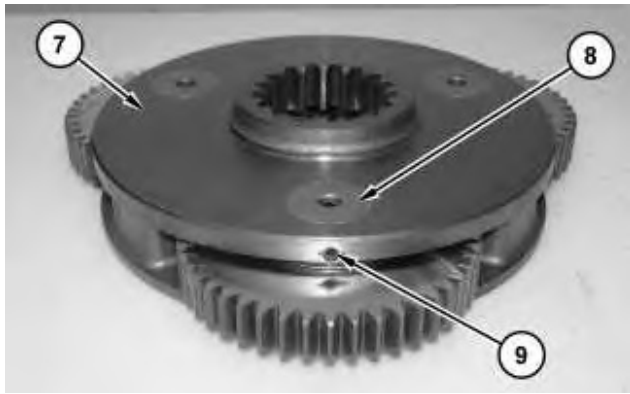

Illustration 12

g01363628

7. Disassemble planetary carrier (7), as follows:

- a. Use a suitable driver to drive spring pin (9) into planetary shaft (8).

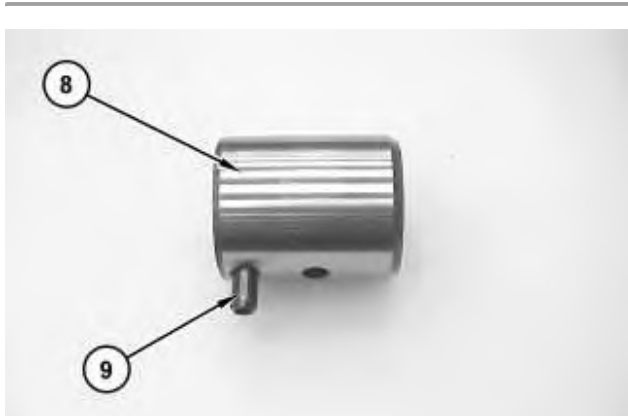

Illustration 13

g01363653

- b. Remove planetary shaft (8) with spring pin (9) from the carrier assembly.
- c. Remove spring pin (9) from planetary shaft (8) with a suitable driver.

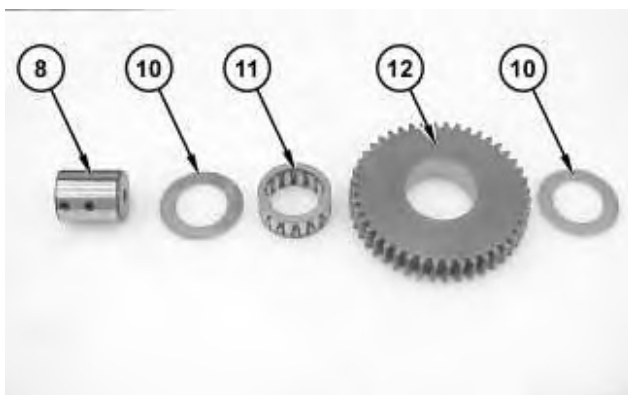

Illustration 14

g01363638

- d. Remove thrust washers (10) and planetary gear (12) from the carrier assembly.

e. Remove bearing (11) from the planetary gear (12).

8. Repeat Steps 7a through 7e in order to remove the remaining planetary gears from the carrier assembly.



Illustration 15

g01363665

9. Remove sun gear (13).

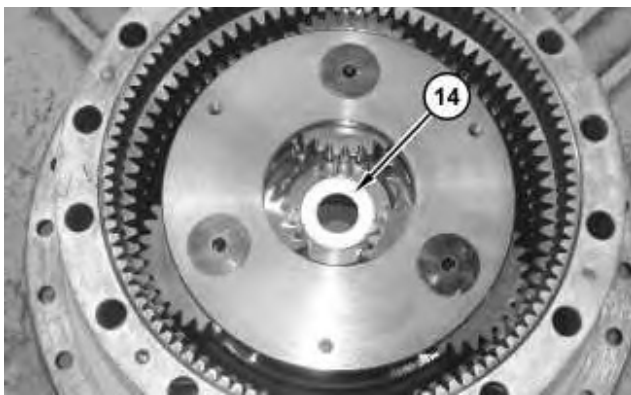

Illustration 16

g01363672

10. Remove spacer (14).

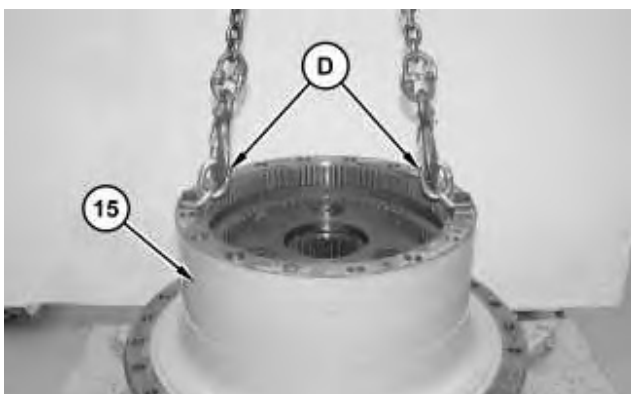

Illustration 17

g01363675

11. Attach Tooling (D) and a suitable lifting device to ring gear (15). The weight of ring gear (15) is approximately 50 kg (110 lb).
12. Remove ring gear (15).

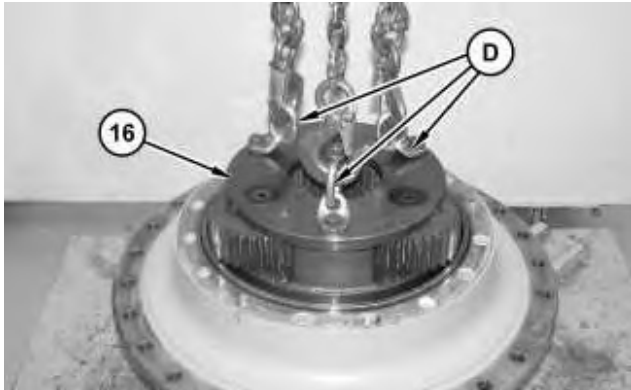

Illustration 18

g01363693

13. Attach Tooling (D) and a suitable lifting device to planetary carrier (16). The weight of planetary carrier (16) is approximately 45 kg (100 lb).
14. Remove planetary carrier (16).

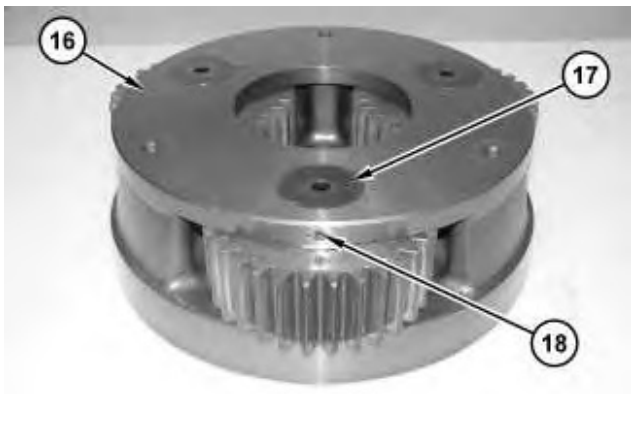

Illustration 19

g01363760

15. Disassemble planetary carrier (16), as follows:
 - a. Use a suitable driver to drive spring pin (18) into planetary shaft (17).
-



Illustration 20

g01363774

- b. Remove planetary shaft (17) with spring pin (18) from planetary carrier (16).
- c. Remove spring pin (18) from planetary shaft (17) with a suitable driver.

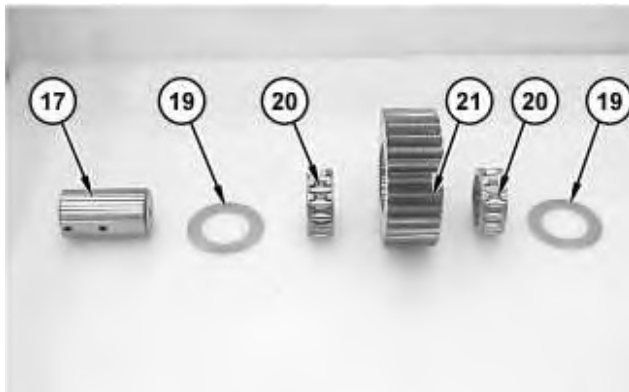

Illustration 21

g01363777

- d. Remove thrust washers (19) and planetary gear (19) from planetary carrier (16).
 - e. Remove bearings (20) from the planetary gear (21).
16. Repeat Steps 15a through 15e in order to remove the remaining planetary gears from the carrier assembly.

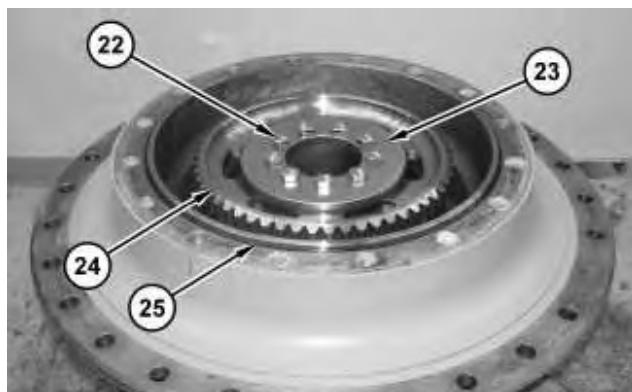

Illustration 22

g01363784

17. Remove bolts (22). Remove retainer (23).
18. Remove coupling gear (24). Remove O-ring (25) from the housing.

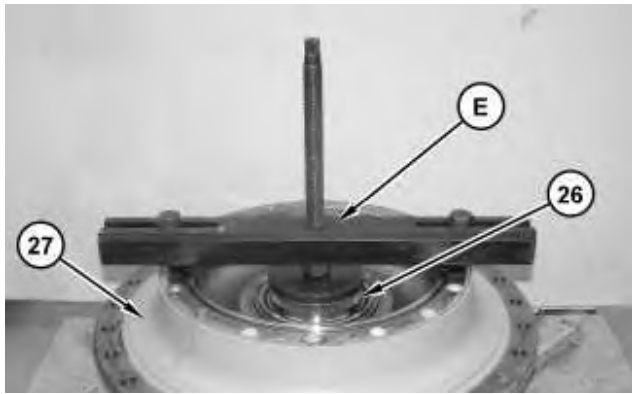

Illustration 23

g01363792

19. Use Tooling (E) in order to separate hub assembly (27) from spindle assembly (26).

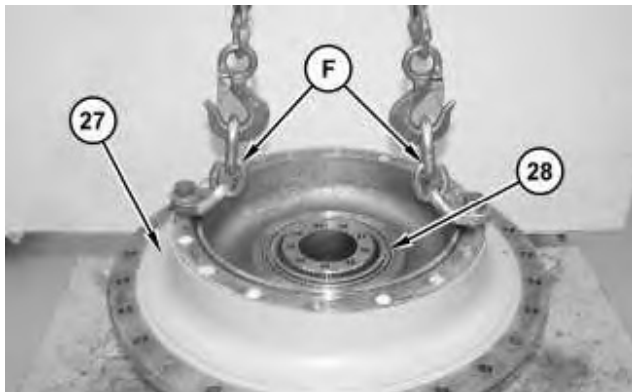

Illustration 24

g01363801

20. Attach Tooling (F) and a suitable lifting device to hub assembly (27). Remove hub assembly (27). The weight of the hub assembly (27) is approximately 113 kg (250 lb).
21. Remove bearing cone (28).

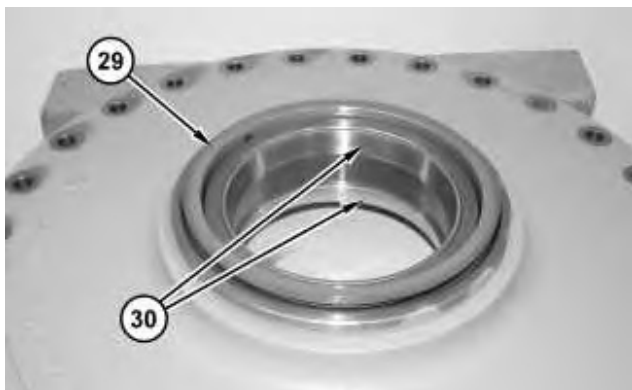

Illustration 25

g01363819

22. Remove Duo-Cone seal (29). Remove bearing cups (30).

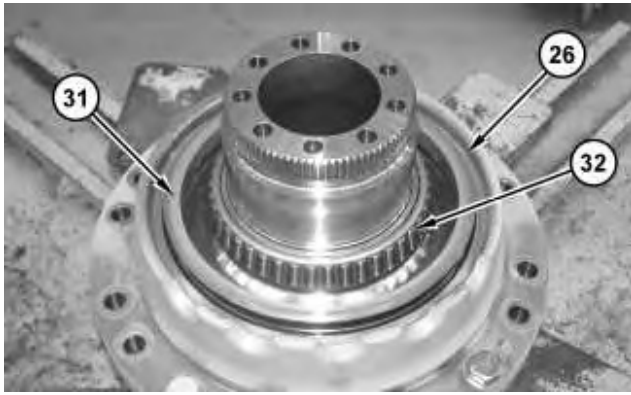

Illustration 26

g01363824

23. Remove Duo-Cone seal (31) from spindle assembly (26). Remove bearing cone (32).

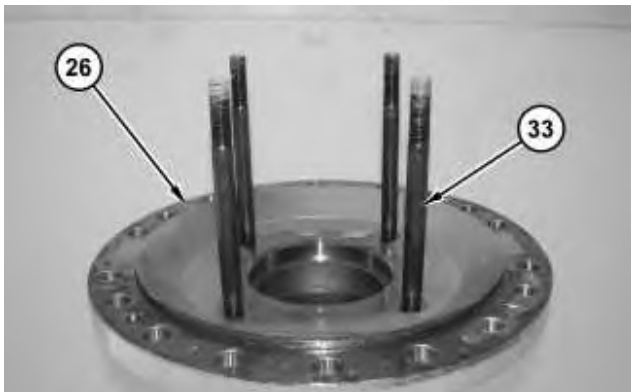

Illustration 27

g01363829

24. Use a suitable lifting device in order to reposition spindle assembly (26). The weight of spindle assembly (26) is approximately 57 kg (125 lb).

25. Remove studs (33).

Assembly Procedure

Table 6

Required Tools			
Tool	Part Number	Part Description	Qty
A	1P-2420	Transmission Repair Stand	1
C	4C-8358	Eyebolt	1
D	138-7575	Link Bracket	3
E	138-7574	Link Bracket	2
G	8C-8422	Sealant	

Note: Cleanliness is an important factor. Before assembly, thoroughly clean all parts in cleaning fluid. Allow the parts to air dry. Do not use wiping cloths or rags to dry parts. Lint may be deposited on the parts which may cause trouble. Inspect all parts. If any parts are worn or damaged, use new parts for replacement. Dirt and other contaminants can damage the precision component. Perform assembly procedures on a clean work surface. Keep components covered and protected at all times.

Note: Apply a light film of hydraulic oil to all components before assembly.

Note: The rubber seals and all surfaces that make contact with the seals must be clean and dry. After installation of the seals, put clean SAE 30 oil on the contact surfaces of the metal seals.

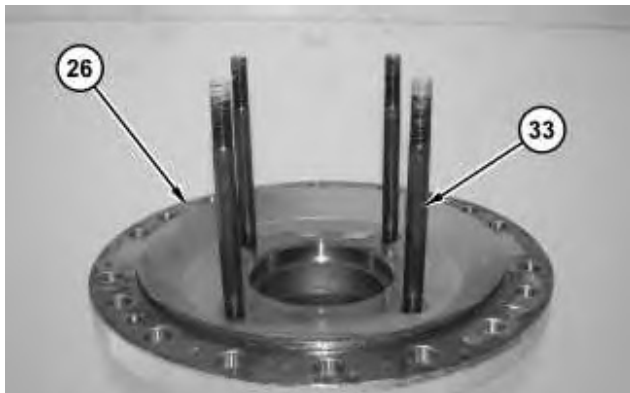

Illustration 28

g01363829

1. Install studs (33). Tighten studs (33) to a torque of 110 ± 20 N·m (81 ± 15 lb ft).
2. Use a suitable lifting device in order to reposition spindle assembly (26). The weight of spindle assembly (26) is approximately 57 kg (125 lb).

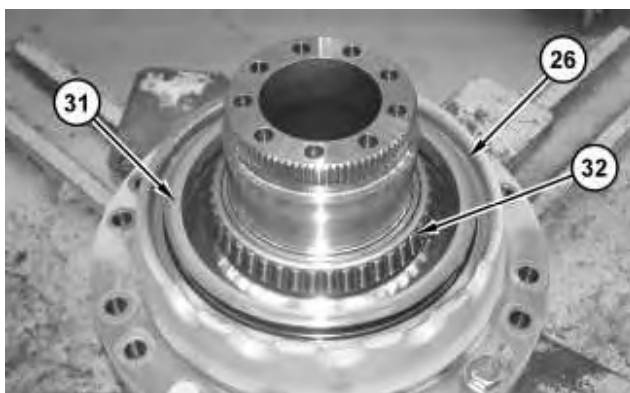

Illustration 29

g01363824

3. Raise the temperature of bearing cone (32) for installation. Install bearing cone (32).

Note: Do not heat the bearing cone over 120°F. Do not heat the bearing cone for more than eight hours.

4. Install Duo-Cone seal (31) onto spindle (26). Refer to Disassembly and Assembly, "Duo-Cone Conventional Seals - Install".

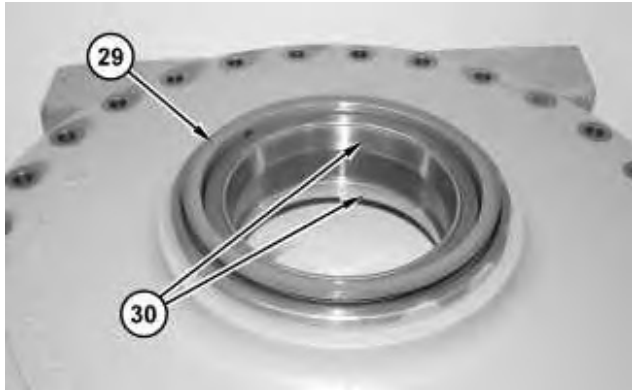

Illustration 30

g01363819

5. Lower the temperature of bearing cup (30) for installation. Install bearing cups (30).
6. Install Duo-Cone seal (29). Refer to Disassembly and Assembly, "Duo-Cone Conventional Seals - Install".



Illustration 31

g01364058

7. Attach Tooling (E) and a suitable lifting device to hub assembly (27). Install hub assembly (27). The weight of hub assembly (27) is approximately 113 kg (250 lb).
8. Raise the temperature of bearing cone (28) for installation. Install bearing cone (28).

Note: Do not heat the bearing cone over 120°F. Do not heat the bearing cone for more than eight hours.

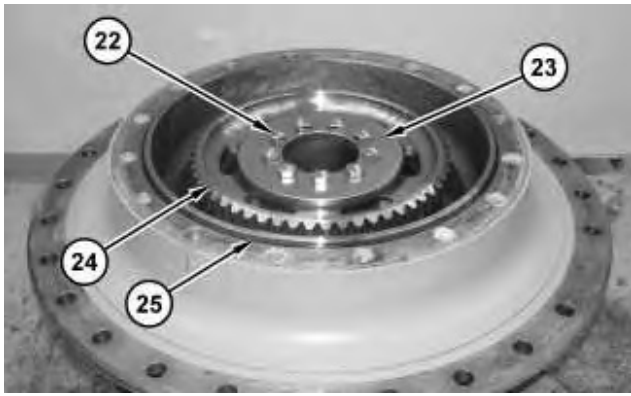

Illustration 32

g01363784

9. Install O-ring seal (25) onto the housing. Remove coupling gear (24).
10. Install retainer (23). Install bolts (22). Tighten bolts (22) to a torque of $120 \pm 20 \text{ N}\cdot\text{m}$ ($89 \pm 15 \text{ lb ft}$).

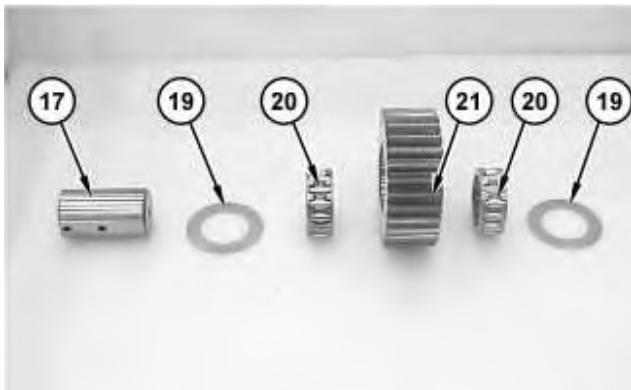

Illustration 33

g01363777

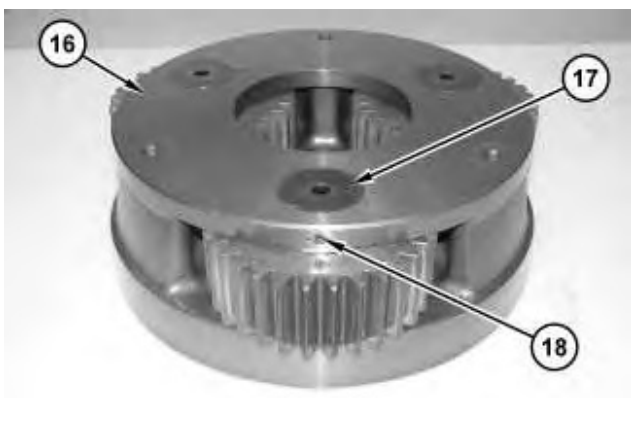

Illustration 34

g01363760

11. Assemble planetary carrier (16), as follows:
 - a. Install bearings (20) into planetary gear (21).
 - b. Install thrust washers (19) and planetary gear (21) into the carrier assembly.

- c. Use a deburring tool in order to remove the metal burr from the openings in the carrier assembly. Install planetary shaft (17) into the carrier assembly.
 - d. Use a suitable driver to drive spring pin (18) into planetary shaft (17). Stake the hole for spring pin (18) in order to retain spring pin (18).
12. Repeat Steps 11a through 11d for the remaining planetary gears.

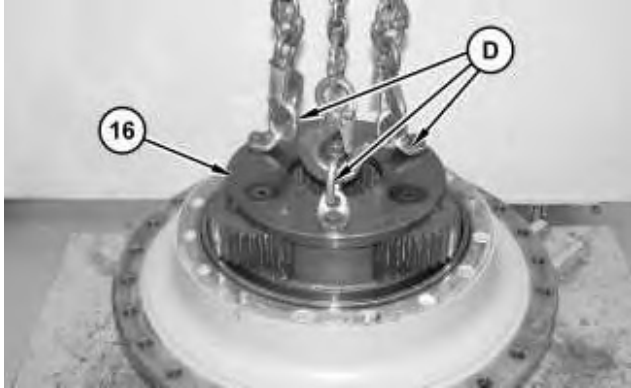

Illustration 35

g01363693

13. Attach Tooling (D) and a suitable lifting device to planetary carrier (16). The weight of planetary carrier (16) is approximately 45 kg (100 lb).
14. Position planetary carrier (16) onto the spindle.

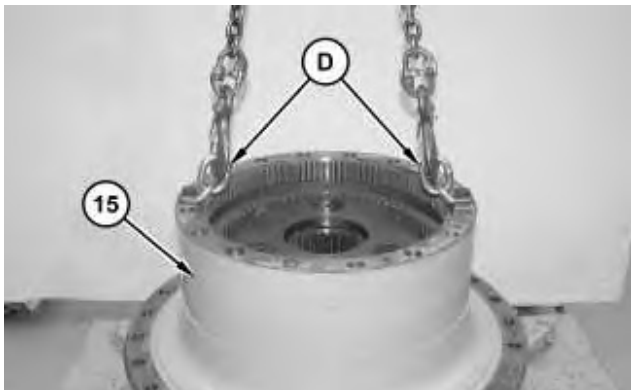

Illustration 36

g01363675

15. Attach Tooling (D) and a suitable lifting device to ring gear (15). The weight of ring gear (15) is approximately 50 kg (110 lb).
16. Install ring gear (15).
-

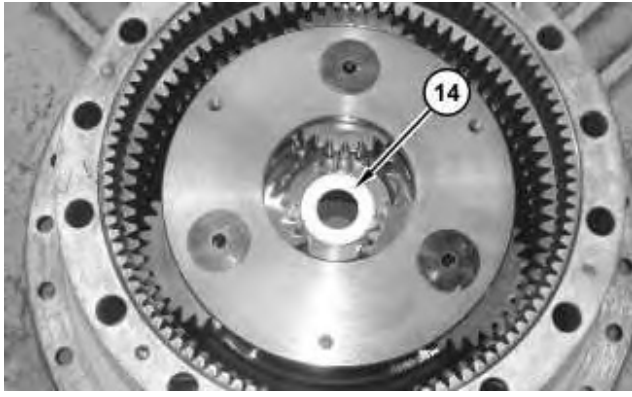

Illustration 37

g01363672

17. Install spacer (14).



Illustration 38

g01363665

18. Install sun gear (13).

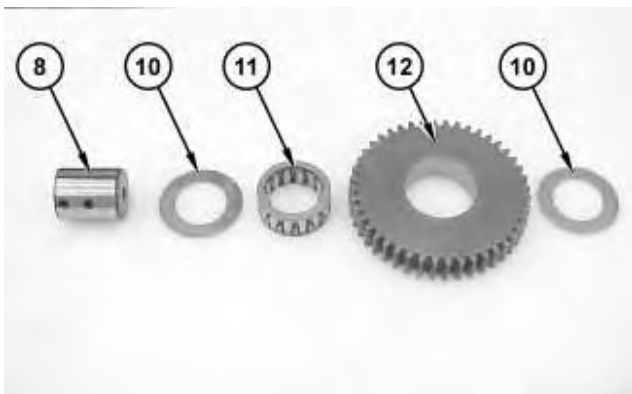

Illustration 39

g01363638

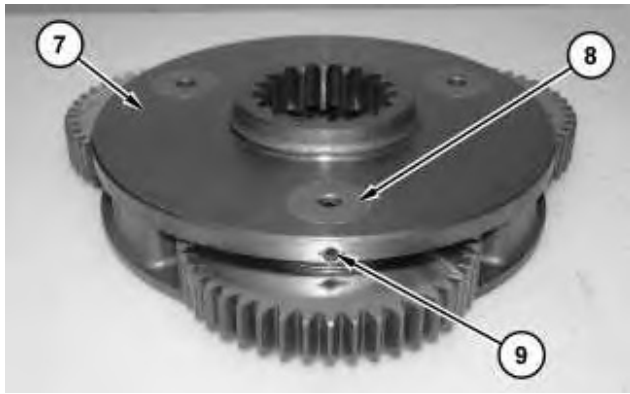

Illustration 40

g01363628

19. Assemble planetary carrier (7), as follows:
 - a. Install bearing (11) into planetary gear (12).
 - b. Install thrust washers (10) and planetary gear (12) into the carrier assembly.
 - c. Use a deburring tool in order to remove the metal burr from the openings in the carrier assembly.
 - d. Install planetary shaft (8) into the carrier assembly.
 - e. Use a suitable driver to drive spring pin (9) into planetary shaft (8). Stake the hole for spring pin (9) in order to retain spring pin (9).
20. Repeat Steps 19a through 19e for the remaining planetary gears.

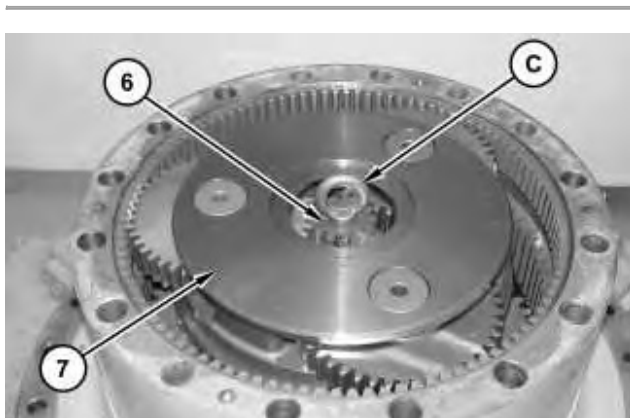

Illustration 41

g01363616

21. Use two people to install planetary carrier (7). The weight of planetary carrier (7) is approximately 23 kg (50 lb).
22. Use Tooling (C) in order to install sun gear (6).

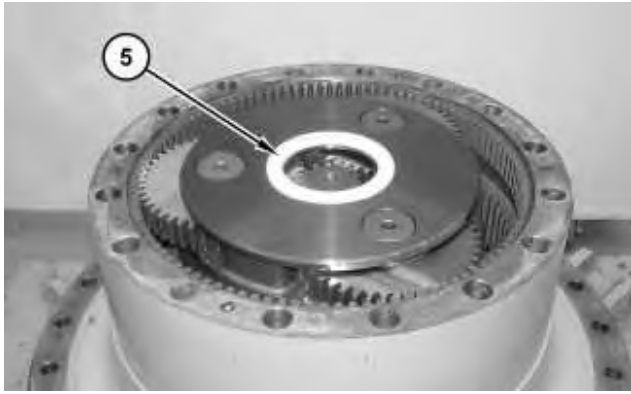

Illustration 42

g01363600

23. Install spacer (5).

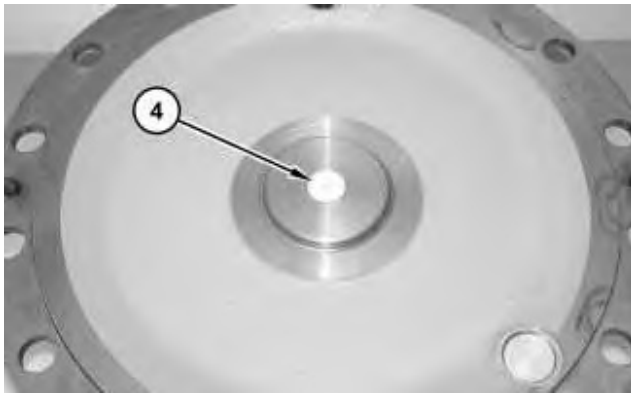

Illustration 43

g01363593

24. Install new plug (4).



Illustration 44

g01364179

25. Apply Tooling (G) to the mounting flange of cover assembly (3) prior to installation.
26. Install cover assembly (3).
27. Install bolts (1). Tighten bolts (1) to a torque of 530 ± 70 N·m (391 ± 52 lb ft).

Thank you so much for reading.
Please click the “Buy Now!”
button below to download the
complete manual.



After you pay.

You can download the most
perfect and complete manual in
the world immediately.

Our support email:

ebooklibonline@outlook.com