

Product: TRACK-TYPE TRACTOR

Model: D5M TRACK-TYPE TRACTOR 4BR

Configuration: D5M & D5M LGP Track-Type Tractor 4BR00001-UP (MACHINE) POWERED BY 3116 Engine

## **Disassembly and Assembly**

### **446 and 446B Backhoe Loaders, Lexion 450 Combine, 3114 and 3116 Engines, IT18F Integrated Toolcarrier, D6M Track-Type Tractor and 928F, 950F and 950G Wheel Loaders**

Media Number -SEN3611-18

Publication Date -01/05/2009

Date Updated -27/05/2009

i01935828

## **Cylinder Head - Remove**

SMCS - 1100-011

### **Removal Procedure**

#### **Start By:**

- a. Remove the fuel filter base. Refer to Disassembly and Assembly, "Fuel Filter Base - Remove and Install".
- b. Remove the governor. Refer to Disassembly and Assembly, "Governor - Remove".
- c. Remove the fuel control linkage. Refer to Disassembly and Assembly, "Fuel Injection Control Linkage - Remove".
- d. Remove the unit injectors. Refer to Disassembly and Assembly, "Unit Injector - Remove".
- e. Remove the water temperature regulator housing. Refer to Disassembly and Assembly, "Water Temperature Regulator Housing - Remove and Install".
- f. Remove the inlet manifold. Refer to Disassembly and Assembly, "Inlet Manifold - Remove".
- g. Remove the exhaust manifold. Refer to Disassembly and Assembly, "Exhaust Manifold - Remove and Install".

---

#### **NOTICE**

**Keep all parts clean from contaminants.**

**Contaminants may cause rapid wear and shortened component life.**

---

---

## NOTICE

**Care must be taken to ensure that fluids are contained during performance of inspection, maintenance, testing, adjusting, and repair of the product. Be prepared to collect the fluid with suitable containers before opening any compartment or disassembling any component containing fluids.**

**Refer to Special Publication, NENG2500, "Dealer Service Tool Catalog" for tools and supplies suitable to collect and contain fluids on Cat products.**

**Dispose of all fluids according to local regulations and mandates.**

---

**Note:** For information on the reusability of the cylinder head, refer to Guideline For Reusable Parts And Salvage Operations, SEBF8218, "Specifications for Cylinder Head Assemblies 3114, 3116, and 3126 Engines" and Guideline For Reusable Parts And Salvage Operations, SEBF8162, "Procedure to Measure and Salvage Cylinder Head Assemblies and Related Components".

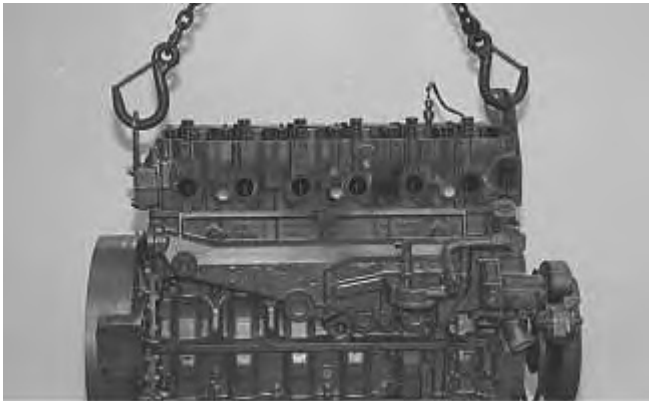

---

Illustration 1  
Typical example

g01007597

1. Attach a suitable lifting device to the cylinder head.
-

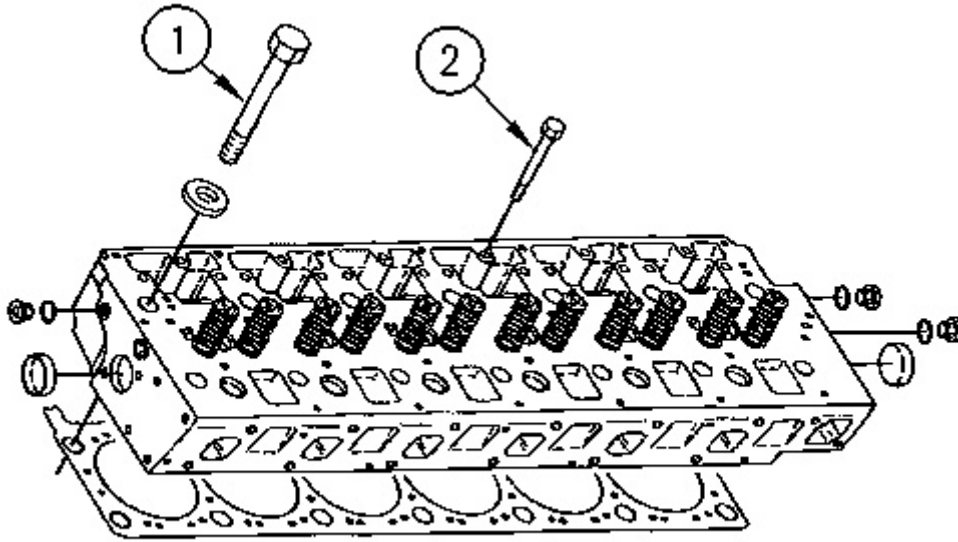

---

Illustration 2

g00654709

2. Remove bolts (1) and (2) that hold the cylinder head to the cylinder block. Carefully remove the cylinder head from the cylinder block. The cylinder head for the 3116 engine weighs approximately 85 kg (187 lb).

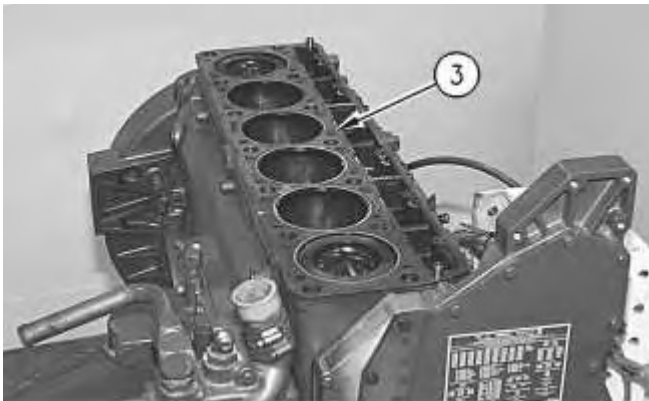

---

Illustration 3

g00611342

3. Remove cylinder head gasket (3).
-

Product: TRACK-TYPE TRACTOR

Model: D5M TRACK-TYPE TRACTOR 4BR

Configuration: D5M & D5M LGP Track-Type Tractor 4BR00001-UP (MACHINE) POWERED BY 3116 Engine

## Disassembly and Assembly

**446 and 446B Backhoe Loaders, Lexion 450 Combine, 3114 and 3116 Engines, IT18F Integrated Toolcarrier, D6M Track-Type Tractor and 928F, 950F and 950G Wheel Loaders**

Media Number -SEN3611-18

Publication Date -01/05/2009

Date Updated -27/05/2009

i04147334

## Cylinder Head - Install

SMCS - 1100-012

## Installation Procedure

Table 1

Required Tools			
Tool	Part Number	Part Description	Qty
A	6V-4876	Lubricant	1

---

### NOTICE

**Keep all parts clean from contaminants.**

**Contaminants may cause rapid wear and shortened component life.**

---

**Note:** For information on the reusability of the cylinder head, refer to Guideline For Reusable Parts And Salvage Operations, SEBF8218, "Specifications for Cylinder Head Assemblies 3114, 3116, and 3126 Engines" and Guideline For Reusable Parts And Salvage Operations, SEBF8162, "Procedure to Measure and Salvage Cylinder Head Assemblies and Related Components".

1. Thoroughly clean the mating surfaces of the cylinder head and the cylinder block.
-

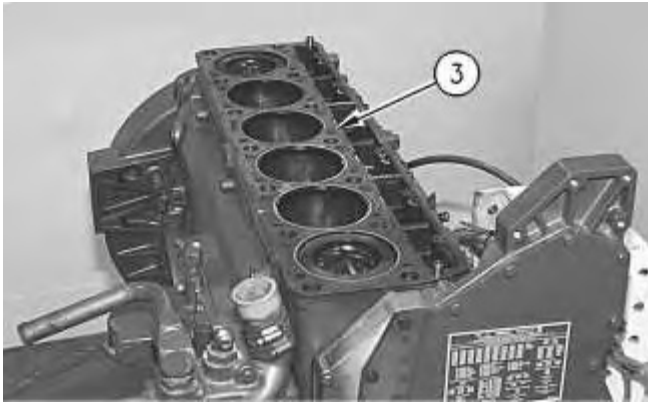

---

Illustration 1

g00611342

Typical example

2. Install a new cylinder head gasket (3) .

**Note:** For information on the cylinder head gasket for 3116 engines, refer to Special Instruction, SEHS9395, "3116 Cylinder Head Gasket Usage".

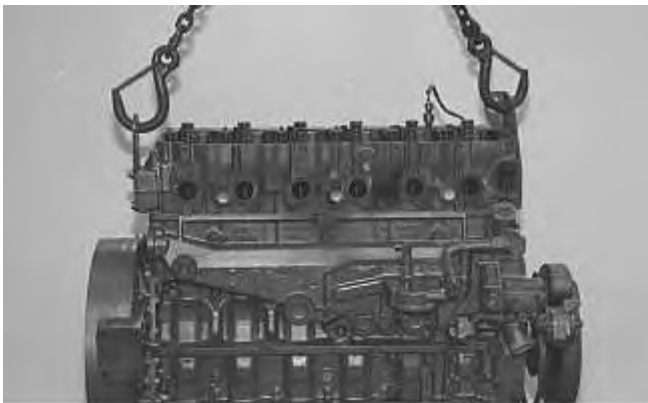

---

Illustration 2

g01007597

Typical example

- Note:** To avoid damage to the cylinder head gasket, use guide bolts of an appropriate size to install the cylinder head.
3. Attach a suitable lifting device to the cylinder head. Position the cylinder head assembly onto the dowels in the cylinder block. Lower the cylinder head onto the cylinder block.
-

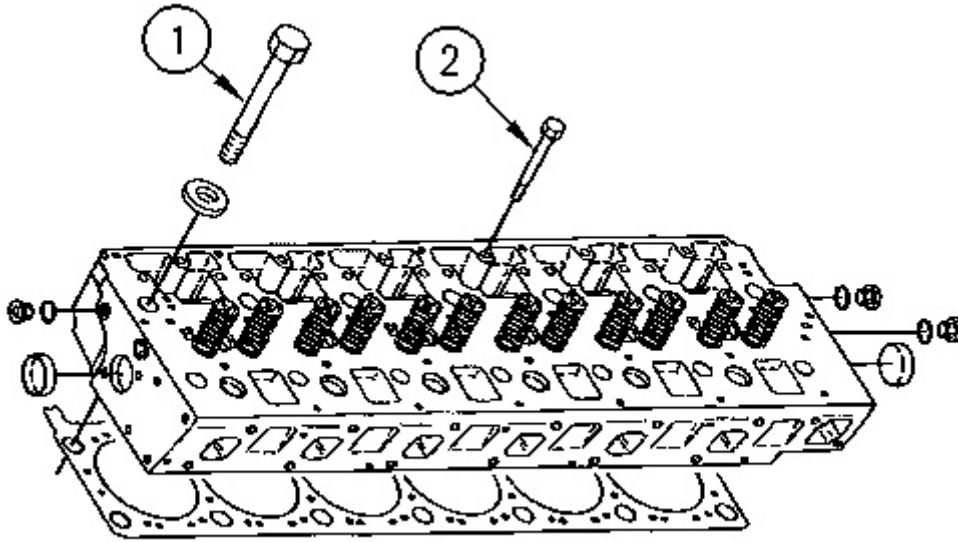

Illustration 3

g00654709

4. Inspect the condition of cylinder head bolts (1) and (2) . For information on the reusability of the bolts, refer to Guideline For Reusable Parts And Salvage Operations, SEBF8301, "Inspection and Reuse of Critical Fasteners Used in All Engines". Replace cylinder head bolts (1) and (2) , if necessary.
5. Lubricate cylinder head bolts (1) and (2) and both sides of the washers with Tooling (A) . Install cylinder head bolts (1) and (2) . Follow Step 6 for the correct tightening procedure.

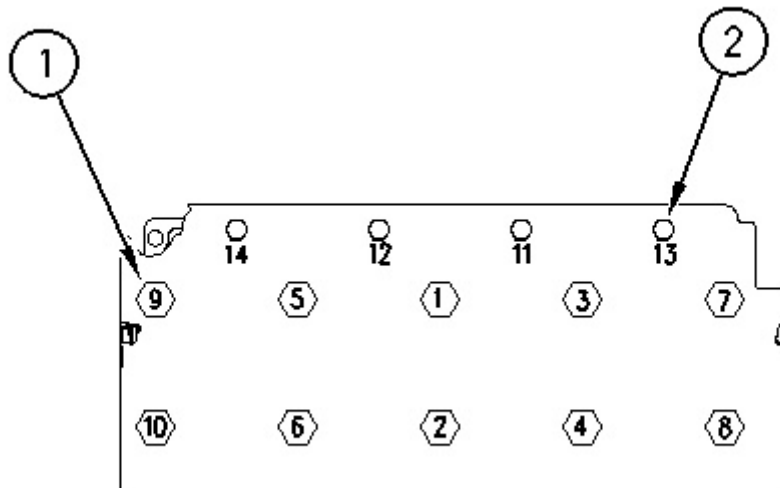
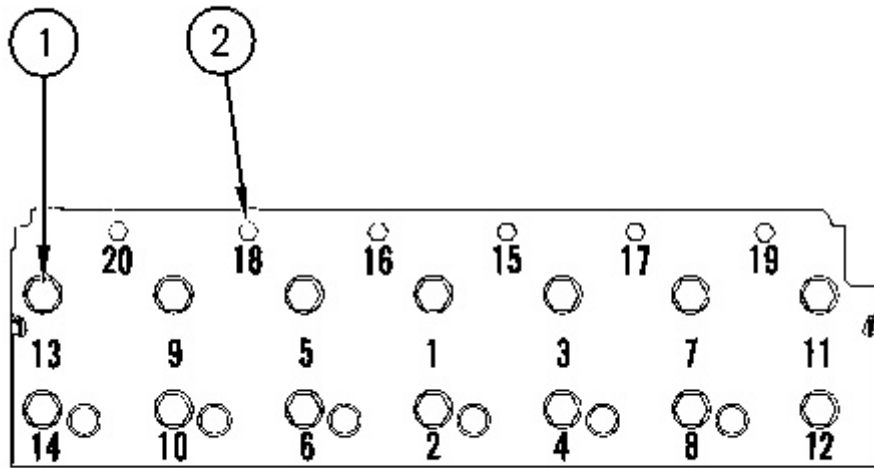

Illustration 4

g00641677



---

Illustration 5

g00611358

6. Tighten the cylinder head bolts according to the following procedure:
7. Tighten bolts (1) through bolt (14) in a numerical sequence to a torque of  $300 \pm 15$  N·m ( $221 \pm 11$  lb ft).
8. Loosen bolts (1) through bolt (14) to a torque of 0 N·m.
9. Tighten bolts (1) through bolt (14) again in a numerical sequence to a torque of  $130 \pm 15$  N·m ( $96 \pm 11$  lb ft).
10. Retighten bolts (1) through bolt (14) again in a numerical sequence to a torque of  $130 \pm 15$  N·m ( $96 \pm 11$  lb ft).
11. Turn bolts (1) through bolt (14) by numerical sequence an additional  $90^\circ$  (1/4 turn).
12. Tighten bolt (15) through bolt (20) in a numerical sequence to a torque of  $55 \pm 7$  N·m ( $41 \pm 5$  lb ft).

**End By:**

- a. Install the exhaust manifold. Refer to Disassembly and Assembly, "Exhaust Manifold - Remove and Install".
  - b. Install the inlet manifold. Refer to Disassembly and Assembly, "Inlet Manifold - Install".
  - c. Install the water temperature regulator housing. Refer to Disassembly and Assembly, "Water Temperature Regulator Housing- Remove and Install".
  - d. Install the unit injectors. Refer to Disassembly and Assembly, "Unit Injector - Install".
  - e. Install the fuel control linkage. Refer to Disassembly and Assembly, "Fuel Injection Control Linkage - Install".
  - f. Install the governor. Refer to Disassembly and Assembly, "Governor - Install".
  - g. Install the fuel filter base. Refer to Disassembly and Assembly, "Fuel Filter Base - Remove and Install".
-

Product: TRACK-TYPE TRACTOR

Model: D5M TRACK-TYPE TRACTOR 4BR

Configuration: D5M & D5M LGP Track-Type Tractor 4BR00001-UP (MACHINE) POWERED BY 3116 Engine

## **Disassembly and Assembly**

**446 and 446B Backhoe Loaders, Lexion 450 Combine, 3114 and 3116 Engines, IT18F Integrated Toolcarrier, D6M Track-Type Tractor and 928F, 950F and 950G Wheel Loaders**

Media Number -SEN3611-18

Publication Date -01/05/2009

Date Updated -27/05/2009

i01930413

# **Lifter Group - Remove and Install**

SMCS - 1209-010

## **Removal Procedure**

### **Start By:**

- a. Remove the rocker shaft and the pushrods. Refer to Disassembly and Assembly, "Rocker Shaft and Pushrod - Remove".

---

### **NOTICE**

**Keep all parts clean from contaminants.**

**Contaminants may cause rapid wear and shortened component life.**

---

---

### **NOTICE**

**Care must be taken to ensure that fluids are contained during performance of inspection, maintenance, testing, adjusting, and repair of the product. Be prepared to collect the fluid with suitable containers before opening any compartment or disassembling any component containing fluids.**

**Refer to Special Publication, NENG2500, "Dealer Service Tool Catalog" for tools and supplies suitable to collect and contain fluids on Cat products.**



**Dispose of all fluids according to local regulations and mandates.**

---

**Note:** For information on reusability of components of the lifter group, refer to Guideline For Reusable Parts And Salvage Operations, SEBF8264, "Camshaft Roller Followers Used in 3114 and 3116 Engines" and Guideline For Reusable Parts And Salvage Operations, SEBF8067, "Slipper Followers and Camshaft Roller Followers".

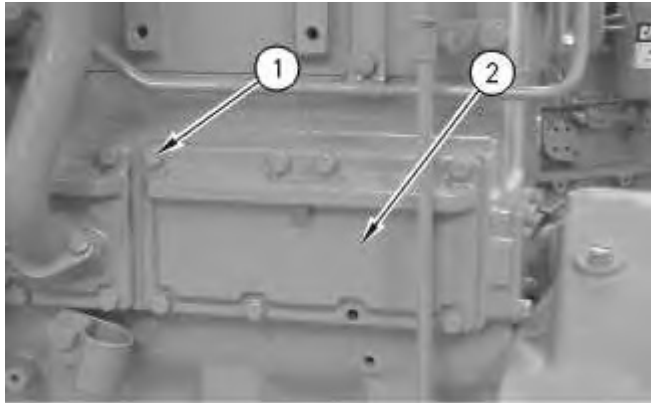

Illustration 1

g00747310

1. Remove bolts (1) from cover (2).
2. Carefully remove cover (2) and the gasket.

**Note:** It may be necessary to remove the governor in order to remove the cover at the front of the engine.

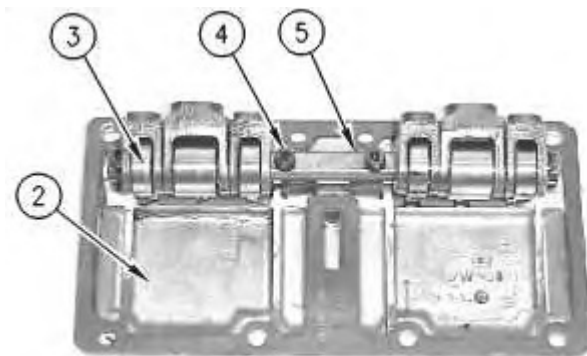

Illustration 2

g00629677

3. Remove bolts (4), lifter shaft (5), and lifters (3) from cover (2).

## **Installation Procedure**

---

## NOTICE

**Keep all parts clean from contaminants.**

**Contaminants may cause rapid wear and shortened component life.**

---

**Note:** For information on reusability of components of the lifter group, refer to Guideline For Reusable Parts And Salvage Operations, SEBF8264, "Camshaft Roller Followers Used in 3114 and 3116 Engines" and Guideline For Reusable Parts And Salvage Operations, SEBF8067, "Slipper Followers and Camshaft Roller Followers".

---

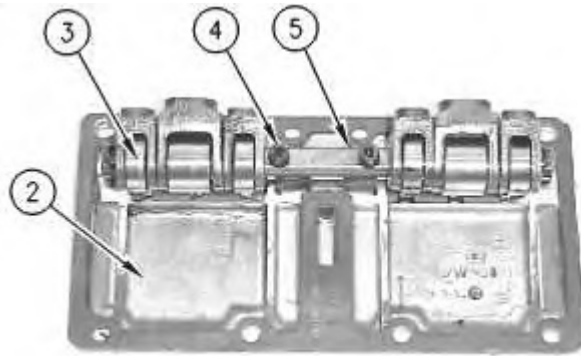

Illustration 3

g00629677

1. Position lifters (3) and lifter shaft (5) on cover (2). Install bolts (4).
- 

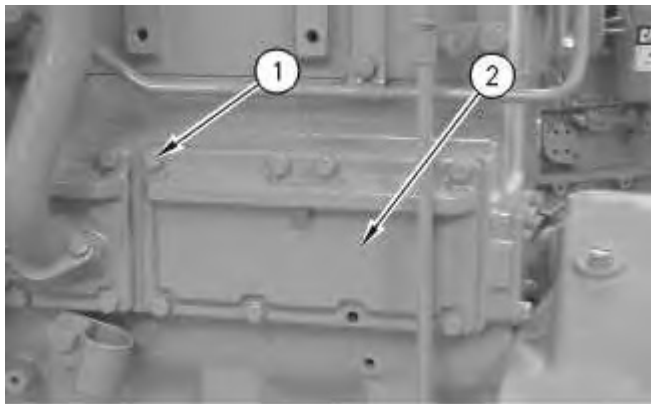

Illustration 4

g00747310

2. Position the gasket and cover (2) on the engine.
3. Install bolts (1) in cover (2).

**End By:**

- a. Install the rocker shaft and the pushrods. Refer to Disassembly and Assembly, "Rocker Shaft and Pushrod - Install".
-

Product: TRACK-TYPE TRACTOR

Model: D5M TRACK-TYPE TRACTOR 4BR

Configuration: D5M & D5M LGP Track-Type Tractor 4BR00001-UP (MACHINE) POWERED BY 3116 Engine

## Disassembly and Assembly

**446 and 446B Backhoe Loaders, Lexion 450 Combine, 3114 and 3116 Engines, IT18F Integrated Toolcarrier, D6M Track-Type Tractor and 928F, 950F and 950G Wheel Loaders**

Media Number -SEN3611-18

Publication Date -01/05/2009

Date Updated -27/05/2009

i01930426

## Camshaft - Remove

SMCS - 1210-011

## Removal Procedure

### Start By:

- a. Remove the governor. Refer to Disassembly and Assembly, "Governor - Remove".
- b. Remove the side covers. Refer to Disassembly and Assembly, "Lifter Group - Remove and Install".
- c. Remove the front cover. Refer to Disassembly and Assembly, "Front Cover - Remove".

---

### NOTICE

**Keep all parts clean from contaminants.**

**Contaminants may cause rapid wear and shortened component life.**

---

---

### NOTICE

**Care must be taken to ensure that fluids are contained during performance of inspection, maintenance, testing, adjusting, and repair of the product. Be prepared to collect the fluid with suitable containers before opening any compartment or disassembling any component containing fluids.**

**Refer to Special Publication, NENG2500, "Dealer Service Tool Catalog" for tools and supplies suitable to collect and contain fluids on Cat products.**

**Dispose of all fluids according to local regulations and mandates.**

---

**Note:** For information on reusability of the camshaft, refer to Guideline For Reusable Parts And Salvage Operations, SEBF8097, "Camshaft Measurement", Guideline For Reusable Parts And Salvage Operations, SEBF8146, "Visual Inspection of Camshafts", and Guideline For Reusable Parts And Salvage Operations, SEBF8251, "Specifications for Measurement of Camshafts in 3114/3116 Engines". For information on reusability of the camshaft gear, refer to Guideline For Reusable Parts And Salvage Operations, SEBF8045, "Timing Gears for All Engines".

**Note:** The air compressor was removed in order to accommodate the engine repair stand.

**Note:** It is not necessary to remove the cylinder head for removal of the camshaft.

1. Turn the crankshaft to top center compression stroke for the No. 1 piston. Install the timing bolt in the flywheel. This is for timing during installation.

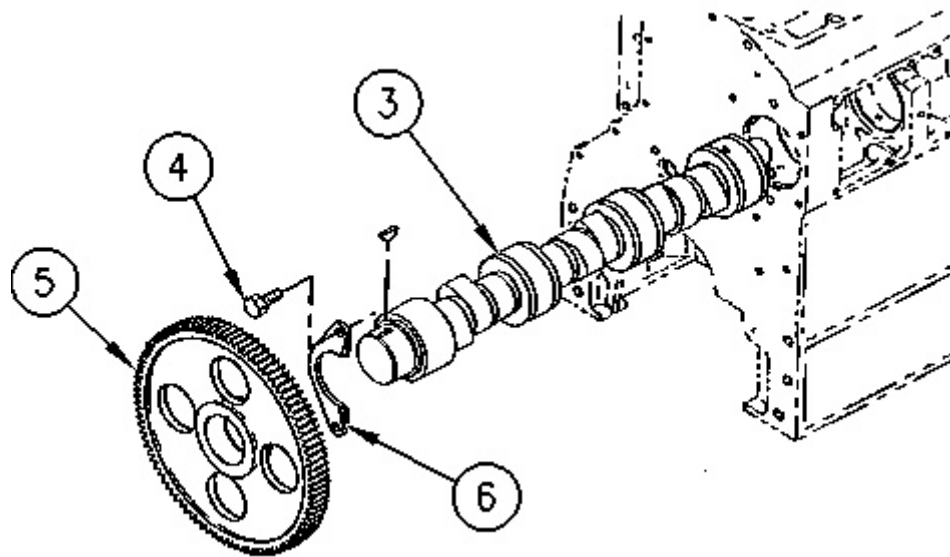

Illustration 1

g01007643

Typical example

2. Ensure that timing mark (1) on the camshaft gear is aligned with timing mark (2) on the idler gear.
-



---

Illustration 2

g01007645

3. Remove bolts (4) and camshaft retainer plate (6).
  4. Remove camshaft gear (5) and camshaft (3) from the cylinder block.
-

Product: TRACK-TYPE TRACTOR

Model: D5M TRACK-TYPE TRACTOR 4BR

Configuration: D5M & D5M LGP Track-Type Tractor 4BR00001-UP (MACHINE) POWERED BY 3116 Engine

## Disassembly and Assembly

**446 and 446B Backhoe Loaders, Lexion 450 Combine, 3114 and 3116 Engines, IT18F Integrated Toolcarrier, D6M Track-Type Tractor and 928F, 950F and 950G Wheel Loaders**

Media Number -SEN3611-18

Publication Date -01/05/2009

Date Updated -27/05/2009

i01936378

## Camshaft - Install

SMCS - 1210-012

## Installation Procedure

---

### NOTICE

**Keep all parts clean from contaminants.**

**Contaminants may cause rapid wear and shortened component life.**

---

**Note:** For information on reusability of the camshaft, refer to Guideline For Reusable Parts And Salvage Operations, SEBF8097, "Camshaft Measurement", Guideline For Reusable Parts And Salvage Operations, SEBF8146, "Visual Inspection of Camshafts", and Guideline For Reusable Parts And Salvage Operations, SEBF8251, "Specifications for Measurement of Camshafts in 3114/3116 Engines". For information on reusability of the camshaft gear, refer to Guideline For Reusable Parts And Salvage Operations, SEBF8045, "Timing Gears for All Engines".

1. Lubricate the camshaft and the camshaft bearings with clean engine oil.
-

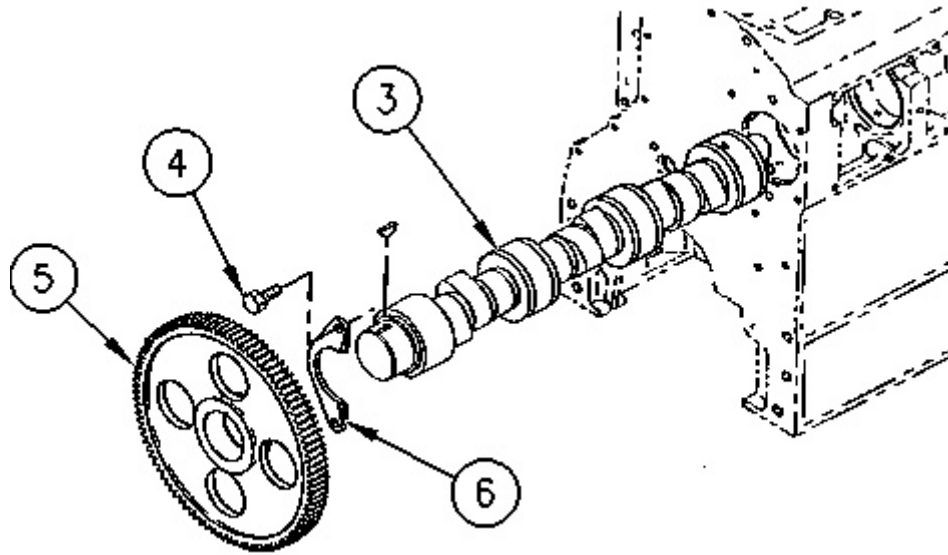

Illustration 1

g01007645

2. Carefully install camshaft (3) and camshaft gear (5) in the engine.

### NOTICE

**When installing the camshaft, make sure the number one cylinder is at top center of the compression stroke with the timing bolt installed in the flywheel. The camshaft timing is very important. The timing mark on the camshaft drive gear must line up with the timing mark on the idler gear. Refer to the Specifications Manual for more information.**



Illustration 2

g01007643

Typical example

3. Ensure that timing mark (1) on the camshaft gear is aligned with timing mark (2) on the idler gear.



4. Install camshaft retainer plate (6) and bolts (4).

**End By:**

- a. Install the front cover. Refer to Disassembly and Assembly, "Front Cover - Install".
  - b. Install the side cover. Refer to Disassembly and Assembly, "Lifter Group - Remove and Install".
  - c. Install the governor. Refer to Disassembly and Assembly, "Governor - Install".
-

Product: TRACK-TYPE TRACTOR

Model: D5M TRACK-TYPE TRACTOR 4BR

Configuration: D5M & D5M LGP Track-Type Tractor 4BR00001-UP (MACHINE) POWERED BY 3116 Engine

## Disassembly and Assembly

**446 and 446B Backhoe Loaders, Lexion 450 Combine, 3114 and 3116 Engines, IT18F Integrated Toolcarrier, D6M Track-Type Tractor and 928F, 950F and 950G Wheel Loaders**

Media Number -SEN3611-18

Publication Date -01/05/2009

Date Updated -27/05/2009

i01171077

# Camshaft Gear - Remove and Install

SMCS - 1210-010-GE

## Removal Procedure

### Start By:

- a. Remove the camshaft. Refer to Disassembly and Assembly, "Camshaft - Remove".

**Note:** For information on reusability of the camshaft gear, refer to Guideline For Reusable Parts And Salvage Operations, SEBF8045, "Timing Gears for All Engines".

1. Wrap the camshaft with a protective covering in order to prevent damage to the camshaft.

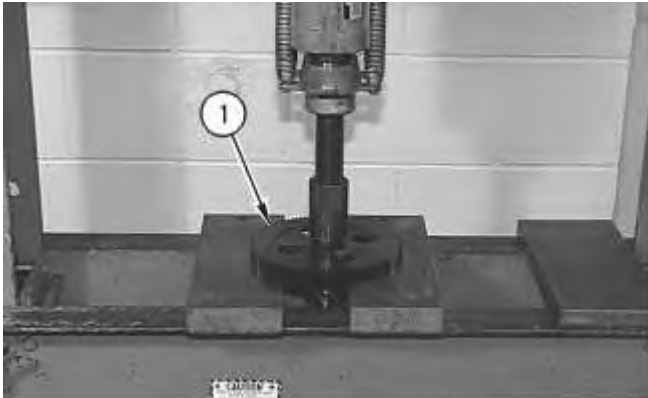

Illustration 1

g00611152

---

**NOTICE**

**Do not allow the camshaft to fall to the floor when pressing it from the drive gear. Also make sure that the camshaft lobes do not catch on the press plates.**

---

2. Place the camshaft and camshaft gear (1) in a suitable press. Press the camshaft from camshaft gear (1).

## Installation Procedure

**Note:** For information on reusability of the camshaft gear, refer to Guideline For Reusable Parts And Salvage Operations, SEBF8045, "Timing Gears for All Engines".

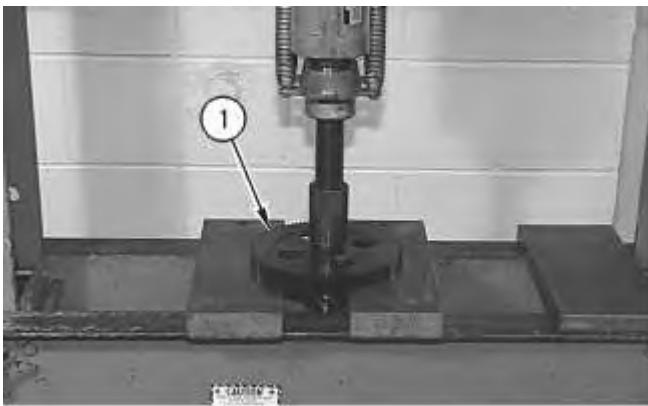

Illustration 2

g00611152

1. Heat the camshaft gear to a maximum temperature of 315 °C (600 °F).
2. Align the key in the camshaft with the groove (keyway) in the camshaft gear.
3. Install the camshaft gear on the end of the camshaft.

### End By:

- a. Install the camshaft. Refer to Disassembly and Assembly, "Camshaft - Install".
-

Thank you so much for reading.  
Please click the “Buy Now!”  
button below to download the  
complete manual.



After you pay.

You can download the most  
perfect and complete manual in  
the world immediately.

Our support email:

[ebooklibonline@outlook.com](mailto:ebooklibonline@outlook.com)